

SPLIT-TYPE AIR CONDITIONERS



Wrap Yourself in Comfort and Quiet  
Eco-conscious Technologies from Japan

Full Product Line Catalogue  
**2024**



# Environmental Sustainability Vision 2050

## Environmental Declaration

Protect the air, land, and water with our hearts and technologies to sustain a better future for all.



## Environmental Sustainability Vision 2050

To solve various factors that lead to environment issues, the Mitsubishi Electric Group shall unite the wishes of each and every person, and strive to create new value for a sustainable future.

## Three Environmental Action Guidelines

1

Apply diverse technologies in wide-ranging business areas to solve environmental issues

2

Challenge to develop business innovations for future generations

3

Publicize and share new values and lifestyles

## Key Initiatives

- Climate Change Measures
- Resource Circulation
- Live in Harmony with Nature
- Long-term Activities
- Innovation
- Nurturing Human Resources
- Understanding Needs
- Co-create and Disseminate New Values
- Live in Harmony with the Region

Heat pump technology inspires Mitsubishi Electric to design air conditioners that harmonize comfort and ecology.

Heat Pump Principle (When Heating)  
<Case of COP 5.0>

Refrigerant and Heat Circulation

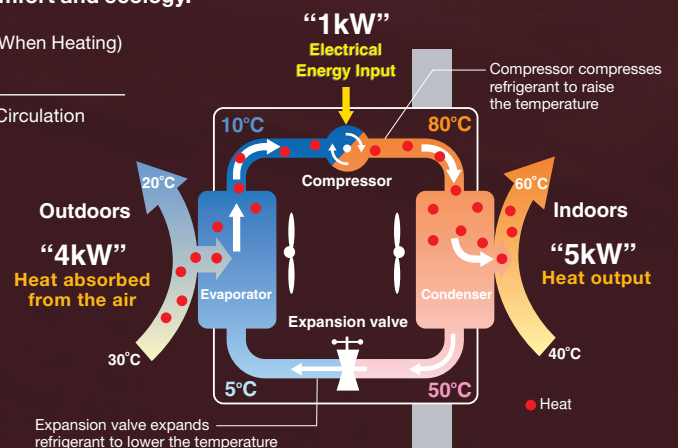



## Mitsubishi Electric takes on the challenge of creating new value and contribute to a sustainable future in order to solve various environmental problems.

### Preventing Global Warming

Mitsubishi Electric is actively introducing R32 refrigerant which has a global warming potential approximately 1/3 that of R410A refrigerant. Not only by shifting from R410A to R32 but by decreasing the diameter of refrigerant piping, we are also striving to reduce the amount of refrigerant usage. Through these activities, we have achieved significant reduction in CO<sub>2</sub> equivalent amount compared to conventional models and realised minimizing the negative impact to the environment more than ever.

#### Reducing the amount of refrigerant usage

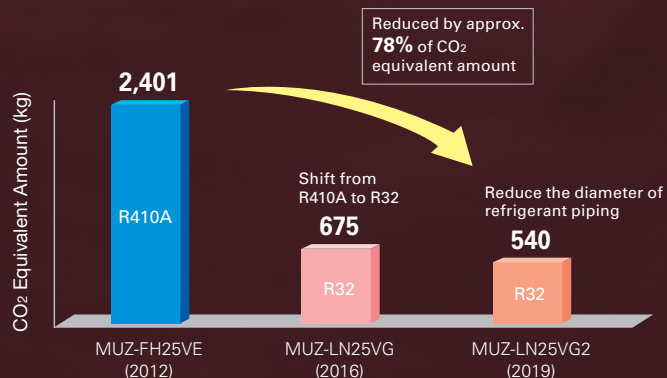

\* reduction rate differs model by model.

### Effective use of materials (Reduce & Recycle)

1. Accelerating the downsizing technology to reduce material use while balancing energy saving performance.
2. Designing products that are easy to separate and recycle.
3. All models are designed for WEEE and RoHS (II) compliance.\*

\*WEEE and RoHS directive: The Waste Electrical and Electronic Equipment (WEEE) Directive is a recycling directive for this type for equipment, while the Restrictions of Hazardous Substances (RoHS) Directive is an EU directive restricting the use of ten specified substances in electronic and electrical devices. In the EU, it is no longer possible (from July 2019) to sell products containing any of the ten substances.

### Balancing comfort and ecology

Mitsubishi Electric develops technologies to balance comfort and ecology, achieving greater efficiency in heat pump operation.

	Comfort	Ecology
<b>1. Inverter</b>	Faster start-up and more stable indoor temperature than non-inverter units.	Fewer On/Off operations than with non-inverter, saving energy.
<b>2. 3D i-see Sensor</b>	Since the positions of people can be detected, airflow can be set to personal taste, such as in airflow path or protected from the wind. The ability to adjust to individual preferences realizes more comfortable air conditioning.	Since the number of people in a room can be detected, energy-saving operation is adjusted or the power is turned off automatically. Efficient air conditioning with less waste is realized.
<b>3. Flash Injection</b>	Achieves high heating capacity even at low temperatures, plus faster start-up compared to conventional inverters.	Expands heat pump heating system to the cold regions to replace combustion heaters.
<b>4. Dual Barrier Coating Dual Barrier Material</b>	Prevents the indoor unit from getting dirty, delivering you clean air.	Keeping the inside of air conditioner clean leads to efficient operation and energy saving.

# CONTENTS



#### Air Conditioners

---

<b>New releases</b> .....	<b>005-006</b>
<b>LINE-UP</b> .....	<b>007-010</b>
<b>M SERIES</b> .....	<b>011-054</b>
<b>S SERIES</b> .....	<b>055-068</b>
<b>P SERIES</b> .....	<b>069-106</b>
<b>MULTI SPLIT SERIES</b> .....	<b>107-118</b>
<b>VRF SERIES</b> .....	<b>119-130</b>

#### Air Conditioners

---

<b>NEW ECODESIGN DIRECTIVE</b> .....	<b>131-132</b>
<b>COMFORT</b> .....	<b>133-134</b>
<b>AIR QUALITY</b> .....	<b>135-137</b>
<b>CONVENIENCE</b> .....	<b>139-140</b>
<b>INSTALLATION &amp; MAINTENANCE</b> .....	<b>141-142</b>
<b>SYSTEM CONTROL</b> .....	<b>143-144</b>
<b>CONTROL TECHNOLOGIES</b> .....	<b>145-150</b>
<b>SYSTEM CONTROL</b> .....	<b>151-152</b>
<b>FUNCTION LIST</b> .....	<b>153-159</b>
<b>OPTIONAL PARTS</b> .....	<b>161-172</b>
<b>EXTERNAL DIMENSIONS</b> .....	<b>173-192</b>
<b>PIPING INSTALLATION</b> .....	<b>193-204</b>

#### M/S/P/Multi/Zubadan/ATW

---

<b>CONDITIONS FOR SPECIFICATIONS</b> .....	<b>205</b>
<b>REFRIGERANT AMOUNT</b> .....	<b>206</b>
<b>R32 REFRIGERANT</b> .....	<b>207-208</b>

#### LOSSNAY SYSTEM

---

<b>FEATURES &amp; SPECIFICATIONS</b> .....	<b>209-250</b>
--	----------------



# New releases

## M SERIES



R32

MSZ-AY15/20VGK(P)

P.25

## VRF SERIES











R32

PUMY-SM112/125/140V/YKM

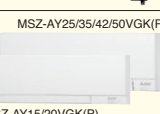
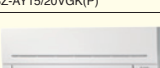
P.125

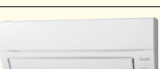
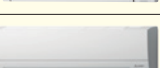
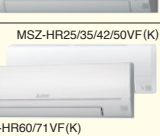
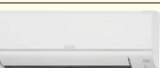
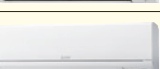
# LINE-UP

## M SERIES INVERTER Models

Model Name		1.5kW	1.8kW	2.0kW	2.2kW	2.5kW	3.5kW	4.2kW	5.0kW	6.0kW	7.1kW	Page	
		1-phase	1-phase	1-phase	1-phase	1-phase	1-phase	1-phase	1-phase	1-phase	1-phase		
Wall-mounted	MSZ-RW VGHZ Series <b>R32 R410A</b> *1 					SINGLE <sub>H</sub>	SINGLE <sub>H</sub>		SINGLE <sub>H</sub>			13	
	MSZ-LN Series <b>R32 R410A</b> *1 		WVRB Multi connection only			WVRB SINGLE	WVRB SINGLE		WVRB SINGLE	WVRB SINGLE		17	
	MSZ-LN VGHZ Series <b>R32 R410A</b> *1 					SINGLE <sub>H</sub>	SINGLE <sub>H</sub>		SINGLE <sub>H</sub>			22	
	MSZ-AY series <b>R32 R410A</b> *2  MSZ-AY25/35/42/50VGK(P) MSZ-AY15/20VGK(P)	SINGLE		SINGLE		SINGLE <sub>H</sub>	SINGLE <sub>H</sub>	SINGLE <sub>H</sub>	SINGLE <sub>H</sub>	SINGLE <sub>H</sub>			25
	MSZ-AP series <b>R32 R410A</b> *1 									SINGLE	SINGLE		29
	MSZ-E Series <b>R32 R410A</b> *1 		WSB Multi connection only		WSB Multi connection only	WSB SINGLE <sub>H</sub>	WSB SINGLE <sub>H</sub>	WSB SINGLE	WSB SINGLE	WSB SINGLE			33
	MSZ-FT VGHZ Series <b>R32</b> 					SINGLE <sub>H</sub>	SINGLE <sub>H</sub>		SINGLE <sub>H</sub>				35
	MSZ-BT Series <b>R32</b> 			SINGLE		SINGLE	SINGLE		SINGLE				37
	MSZ-HR Series <b>R32</b>  MSZ-HR25/35/42/50VF(K) MSZ-HR60/71VF(K)					SINGLE	SINGLE	SINGLE	SINGLE	SINGLE	SINGLE	SINGLE	39
	MSZ-DW Series <b>R32</b> 					SINGLE	SINGLE		SINGLE				41
	MSY-TP Series <b>R32</b> 						SINGLE		SINGLE				43
	Compact floor	MFZ-KT Series <b>R32</b> 					SINGLE	SINGLE		SINGLE	SINGLE		45
MFZ-KW Series <b>R32</b> 						SINGLE <sub>H</sub>	SINGLE <sub>H</sub>		SINGLE <sub>H</sub>	SINGLE <sub>H</sub>		47	
1-way cassette	MLZ Series <b>R32</b>  MLZ-KY20VG MLZ-KP25/35/50VF			Multi connection only		SINGLE	SINGLE		SINGLE			49	

\*1: R410A is for PUMY connection.

\*2: R410A is for MXZ and PUMY connection.

H : Outdoor unit with freeze-prevention heater is available.

W-S-B: Indoor units are available in three colours; White, Black and Silver.

W-V-R-B: Indoor units are available in four colours; Natural White, Pearl White, Ruby Red, and Onyx Black.





**Indoor Combinations**

- SINGLE** 1 outdoor unit & 1 indoor unit
- TWIN** 1 outdoor unit & 2 indoor units
- TRIPLE** 1 outdoor unit & 3 indoor units
- QUADRUPLE** 1 outdoor unit & 4 indoor units

## S SERIES

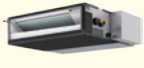
INVERTER Models

Model Name		1.5kW	2.5kW	3.5kW	5.0kW	6.0kW	7.1kW	10.0kW	12.5kW	14.0kW	Page
		1-phase	1-phase	1-phase	1-phase	1-phase	1-phase	1- & 3-phase	1- & 3-phase	1- & 3-phase	
2 x 2 cassette	SLZ Series <b>R32</b> <b>R410A</b>		Multi connection only	SINGLE	SINGLE	SINGLE	SINGLE	TWIN	TWIN TRIPLE	TWIN TRIPLE QUADRUPLE	57
	Compact ceiling-concealed	SEZ Series <b>R32</b> <b>R410A</b>			SINGLE *	SINGLE *	SINGLE *	SINGLE *	SINGLE TWIN	TWIN TRIPLE QUADRUPLE	TWIN TRIPLE QUADRUPLE
Concealed floor standing	SFZ Series <b>R32</b>			SINGLE	SINGLE	SINGLE	SINGLE				66

\* Indoor units are available in two types; with or without the wireless remote controller.

## P SERIES







Power Inverter Models / Standard Inverter Models

Model Name		3.5kW	5.0kW	6.0kW	7.1kW	10.0kW	12.5kW	14.0kW	20.0kW	25.0kW	Page	
		1-phase	1-phase	1-phase	1-phase	1- & 3-phase	1- & 3-phase	1- & 3-phase	3-phase	3-phase		
4-way cassette	PLA Series <b>R32</b> <b>R410A</b>		SINGLE	SINGLE	SINGLE	SINGLE TWIN *	SINGLE TWIN	SINGLE TWIN	SINGLE TWIN TRIPLE	TWIN TRIPLE QUADRUPLE	TWIN TRIPLE QUADRUPLE	80
	Ceiling-concealed	PEAD Series <b>R32</b> <b>R410A</b>		SINGLE	SINGLE	SINGLE	SINGLE TWIN *	SINGLE TWIN	SINGLE TWIN TRIPLE	TWIN TRIPLE QUADRUPLE	TWIN TRIPLE QUADRUPLE	87
	PEA Series <b>R32</b> <b>R410A</b>								SINGLE	SINGLE	90	
Wall-mounted	PKA Series <b>R32</b> <b>R410A</b>		SINGLE *	SINGLE *	SINGLE *	SINGLE TWIN *	SINGLE TWIN	TWIN	TWIN TRIPLE	TWIN TRIPLE QUADRUPLE	TWIN TRIPLE QUADRUPLE	92
Ceiling-suspended	PCA-KA Series <b>R32</b> <b>R410A</b>		SINGLE	SINGLE	SINGLE	SINGLE TWIN *	SINGLE TWIN	SINGLE TWIN TRIPLE	TWIN TRIPLE QUADRUPLE	TWIN TRIPLE QUADRUPLE	TWIN TRIPLE QUADRUPLE	95
for Professional Kitchen	PCA-HA Series* <b>R32</b> <b>R410A</b>					SINGLE *			TWIN *		TRIPLE *	98
Floor-standing	PSA Series <b>R32</b> <b>R410A</b>					SINGLE	SINGLE	SINGLE	SINGLE TWIN	TWIN	TWIN TRIPLE	101



\* Power Inverter Model only

# LINE-UP

## MXZ SERIES INVERTER Models

Model Name	Capacity Class	Page
up to 2 indoor units MXZ-2F33VF4 <b>R32</b>	3.3kW <1-phase>	109
up to 2 indoor units MXZ-2F42VF4 <b>R32</b> 	4.2kW <1-phase>	109
up to 2 indoor units MXZ-2F53VF(H)4 <b>R32</b>	5.3kW <1-phase>	109
up to 3 indoor units MXZ-3F54VF4 <b>R32</b>	5.4kW <1-phase>	109
up to 3 indoor units MXZ-3F68VF4 <b>R32</b> 	6.8kW <1-phase>	109
up to 4 indoor units MXZ-4F72VF4 <b>R32</b>	7.2kW <1-phase>	109
up to 4 indoor units MXZ-4F80VF4 <b>R32</b>	8.0kW <1-phase>	109
up to 4 indoor units MXZ-4F83VF2 <b>R32</b> 	8.3kW <1-phase>	109
up to 5 indoor units MXZ-5F102VF2 <b>R32</b>	10.2kW <1-phase>	109
up to 6 indoor units MXZ-6F120VF2 <b>R32</b> 	12.0kW <1-phase>	109
up to 2 indoor units MXZ-2HA40VF2 <b>R32</b> 	4.0kW <1-phase>	114
up to 2 indoor units MXZ-2HA50VF2 <b>R32</b>	5.0kW <1-phase>	114
up to 3 indoor units MXZ-3HA50VF2 <b>R32</b> 	5.0kW <1-phase>	114



## MXZ-VFHZ SERIES INVERTER Models

Model Name		2.5kW 1-phase	3.5kW 1-phase	5.0kW 1-phase	5.3kW 1-phase	6.0kW 1-phase	8.3kW 1-phase	10.0kW 1 & 3-phase	12.5kW 3-phase	Page
Multi split	MXZ-FVFHZ2 Series MXZ-EVAHZ Series <b>R32</b> <b>R410A</b>  				<b>2PORT</b> <sub>H</sub>		<b>4PORT</b> <sub>H</sub>			111

\* R410A is for PUMY connection.

H: Freeze-prevention heater is included as standard equipment.







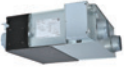

## PUMY SERIES INVERTER Models

Model Name	12.5kW	14.0kW	15.5kW	22.4kW	28.0kW	33.5kW	Page
	1 & 3-phase	1 & 3-phase	1 & 3-phase	3-phase	3-phase	3-phase	
PUMY-SP <b>R410A</b> 	✓	✓	✓				121
PUMY-P <b>R410A</b> 	✓	✓	✓	✓	✓	✓	123
PUMY-SM <b>R32</b> 	✓	✓	✓				125



**Indoor Combinations**

- SINGLE** 1 outdoor unit & 1 indoor unit
- TWIN** 1 outdoor unit & 2 indoor units
- TRIPLE** 1 outdoor unit & 3 indoor units
- QUADRUPLE** 1 outdoor unit & 4 indoor units

# LOSSNAY SERIES

Commercial		Residential	
Ceiling Concealed Type		Vertical Type	Wall Mounted Type
 LGH-RVX3 Series	 LGH-RVS	 VL-CZPVU Series	 VL-100(E)Us-E
 LGH-RVXT Series	 GUF Series		 VL-50(E)S2-E  VL-50SR2-E

# Plasma Quad Protect SERIES

Air purifier	Air circulator
Small Air Volume type	Large Air Volume type
 JC-23KR-EU	 JC-4K-EU











# M



SERIES

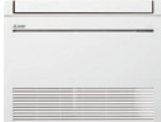

# SELECTION

Choose the model that best matches room conditions.

SELECT SERIES		
A multiple series line-up to choose from, each with various outstanding features. In addition to inverter-equipped models, constant-speed, floor-standing and cassette models can be selected. Choose the best series to match usage needs.		
<b>Wall-mounted Units</b>		
<b>MSZ-RW SERIES</b> <b>R32</b> <b>R410A</b> *2  25/35 SEER A+++ SCOP A+++ MXZ connection 25/35	<b>MSZ-LN SERIES</b> <b>R32</b> <b>R410A</b> *2  25/35 SEER A+++ SCOP A+++ MXZ connection 25/35	<b>MSZ-AY SERIES</b> <b>R32</b> <b>R410A</b> *2 MSZ-AY25/35/42/50VGK(P)  MSZ-AY15/20VGK(P) 25/35 SEER A+++ SCOP A+++ MXZ connection 25/50
<b>MSZ-AP SERIES</b> <b>R32</b> <b>R410A</b> *1  60 SEER A+++ SCOP A+++ MXZ connection 60	<b>MSZ-E SERIES</b> <b>R32</b> <b>R410A</b> *1  25/35 SEER A+++ SCOP A+++ MXZ connection 25/35	<b>MSZ-BT SERIES</b> <b>R32</b>  25/35 SEER A+++ SCOP A+++ MXZ connection 25/35
<b>MSZ-HR SERIES</b> <b>R32</b> MSZ-HR60/71VF(K)  MSZ-HR25-50VF(K) 60 SEER A+++ SCOP A+++ MXZ connection 60	<b>MSZ-DW SERIES</b> <b>R32</b>  35 SEER A+++ SCOP A+++ MXZ connection 35	<b>MSY-TP SERIES</b> <b>R32</b>  35 SEER A+++
<b>Floor-standing</b>		<b>Cassette Units</b>
<b>MFZ SERIES</b> <b>R32</b>  35 SEER A+++ SCOP A+++ MXZ connection 35	<b>MLZ SERIES</b> <b>R32</b>  MLZ-KP25/35/50VF MLZ-KY20VG MXZ connection	SEER A SCOP A Energy Rank MXZ connection Compatible for connection to MXZ Series system <b>R32</b> R32 Refrigerant <b>R410A</b> R410A Refrigerant *1 R410A is for MXZ and PUMY connection. *2 R410A is for PUMY connection.

SELECT OUTDOOR UNIT		
Some outdoor units in the line-up have heaters for use in cold regions. Units with an "H" in the model name are equipped with heaters.		
<b>Heater Installed</b> MUZ-AY25/35/42/50VGH MUZ-EF25/35VGH MUZ-SF25/35/42/50VEH  MUZ-LN25/35VG	<b>Hyper Heating</b> MUZ-RW25/35/50VGHZ MUZ-LN25/35/50VGHZ MUZ-FT25/35/50VGHZ MUZ-FH25/35/50VEHZ MUFZ-KW25/35/50/60VGHZ  MUZ-LN50VG2	<b>Selecting a Heater-equipped Model</b> In regions with the following conditions, there is a possibility that water resulting from condensation on the outdoor unit when operating in the heating mode will freeze and not drain from the base. 1) Cold outdoor temperatures (temperature does not rise above 0°C all day) 2) Areas where dew forms easily (in the mountains, valleys(surrounded by mountains), near a forest, near unfrozen lakes, ponds, rivers or hot springs), or areas with snowfall. To prevent water from freezing in the base, it is recommended that a unit with a built-in heater be purchased. Please ask your dealer representative about the best model for you.

# MSZ-RW SERIES

R32 Single / MXZ, PUMY R410A PUMY

As a flagship model, RW series realises further outstanding heating performances under extremely cold outdoor temperature even with high energy efficiency. Moreover, excellent air purifying functions and many other smart features deliver a great comfort to you.



MSZ-RW25/35/50VG

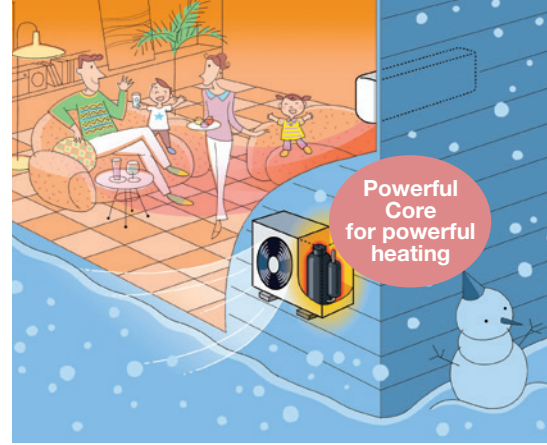

## Heating Performance

Excellent heating performance of RW series delivers the prime warmth into your room. RW series' powerful compressor realises remarkable maximum heating capacity in low ambient temperature with a high energy efficiency. Also, RW series performs 100% rated capacity even at -25°C, and the operation is guaranteed down to -30°C for all classes (25/35/50).

### High Energy Efficiency

RW25	A+++	SCOP 5.2
RW35	A+++	SCOP 5.1
RW50	A++	SCOP 4.6

## Improved Heating Capacity

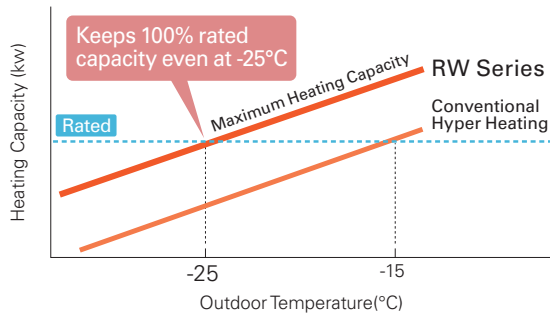

## Wider Heating Operation Range

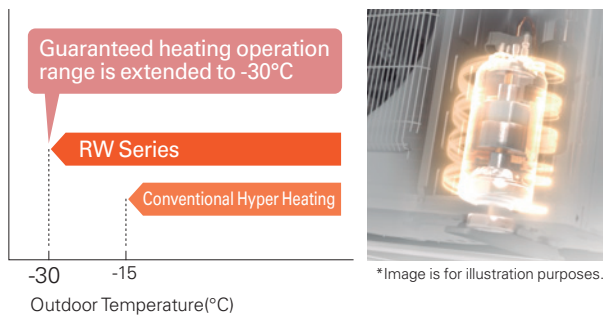

## Longer Continuous Heating Operation

RW series with a high frost-detecting technology, made it possible to provide maximum continuous heating operation as long as 150 minutes with less frequent defrosting operations, maintaining a comfortable indoor environment in a long term.

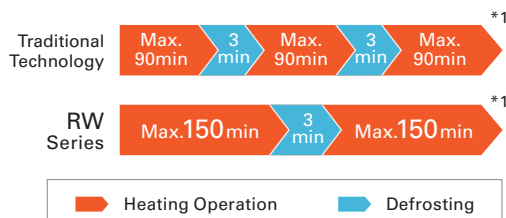

\*1 The time for heating and defrosting operation depends on the environmental conditions.

## Tested in Sweden and Norway

We have conducted field tests in several cold sites and received high user satisfactions with sufficient air volume and remarkable heating performance of RW series. As the test result shows, we confirmed that RW series provides stable indoor comfortability even in extremely low ambient temperature.

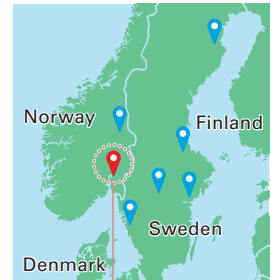

## Test result in Norway

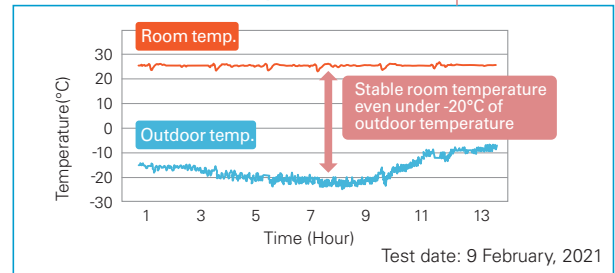

## 3D i-see Sensor

3D i-see sensor with the sophisticated hemispherical design measures the temperature of the room with an infrared sensor and detects the position of people, which allows you to choose your preferable airflow such as indirect and direct airflow.



## Circulator Mode

In heating mode, after reaching the setting temperature, indoor unit automatically starts FAN mode to circulate the air and eliminate temperature unevenness in your room.



# Plasma Quad Plus

Plasma Quad Plus is a plasma-based filtering system which contributes to a better air quality in your room. Plasma Quad Plus applies a voltage of approximately 6,000 volts to the electrode to generate plasma, effectively removing various kinds of airborne particles such as viruses, bacteria, mold, allergen, dust, and PM2.5.

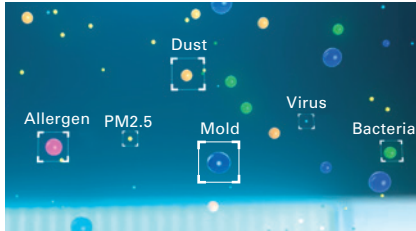

\*Images are for illustration purposes.

Virus (Airborne)

**99% inhibited**\*1

\*1 Tested Organization: vrc. Center, SMC Test Report No: 28-002 Test Method: JEM1467 Test result: Neutralised 99% of Influenza A virus in 72 minutes in a 25m<sup>3</sup> test space.

\*2 Tested Organization: Japan Textile Products Quality and Technology Center, Test Report No: 20KB070569, Tested Materials: SARS-CoV-2, Test Method: Original (The test was conducted on the Plasma Quad device alone, not designed to evaluate product performance.) Test Result: Inhibited 99.8% in 360 minutes. The result without the effect of natural attenuation is 96.3%.

We have confirmed Plasma Quad Plus inhibits 99.8% of adhered COVID-19. \*2

## Quick Air Purifying Set

If you press "PURIFIER" button when the unit is turned off, Plasma Quad Plus starts to operate with a fan mode and purifies the air in your room.

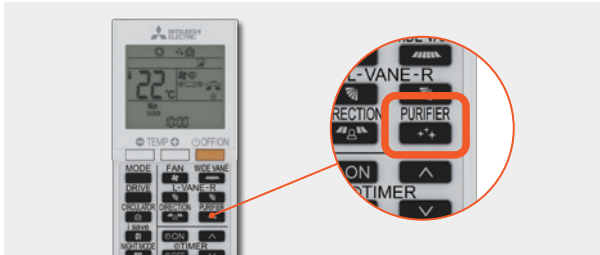

## Deodorising Filter

The catalyst in Deodorising Filter denatures the odorous components and destroys them from the source of the odour, quickly delivering fresh air to your room.

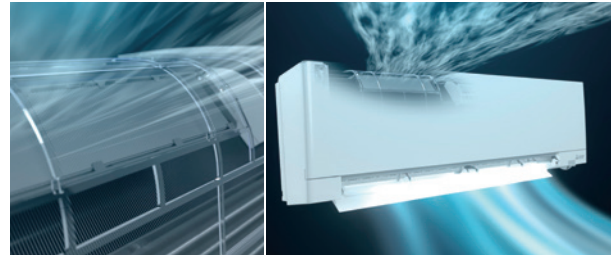

## Dual Barrier Coating

**SIAA** \*1  
Anti Fungus  
JP0512075X0001C  
(Fan, Air duct)

Mitsubishi Electric's Dual Barrier Coating prevents dust and greasy dirt from accumulating on the inner surface of the indoor unit; keeping your air conditioner clean. Two barrier coating prevents hydrophilic dirt penetration, and "hydrophilic particles" prevent hydrophobic dirt from getting into the air conditioner.

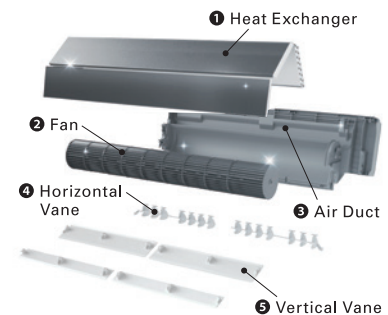
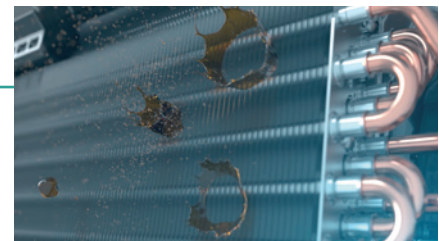

## Dual Barrier Material

**SIAA** \*2  
Anti Fungus  
JP0512075X0001C  
(Horizontal Vane, Vertical Vane)

Dual Barrier Material performs the same antifouling effect as Dual Barrier Coating, and it is kneaded into horizontal vane and vertical vane material which are hard to apply coating to. Combined with Dual Barrier Coating, the whole air passage of indoor unit is kept clean all year round.

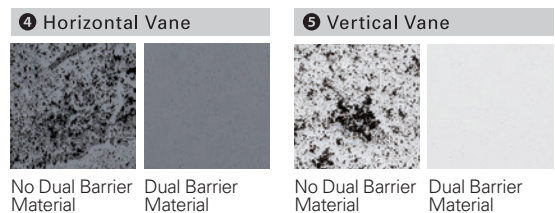

\*Comparison of stains after 10 years of use (based on internal research)

\*1 \*2 Verified by SIAA test method (JIS Z 2911) with No. JP0501014A00020 on SIAA antifungal agent positive list. Antifungal effect depends on the working environment. Fungicides comply with the SIAA safety criteria. What is SIAA? [https://www.kohkin.net/en\\_index.html](https://www.kohkin.net/en_index.html)

## Drive Mode Selector

Drive Mode Selector allows you to select a preferred control setting according to your residential environment from three modes, Wide Room mode, Quiet mode, and Eco mode.

### Wide Room Mode

Provides a better air distribution in your room and raises the comfort level.

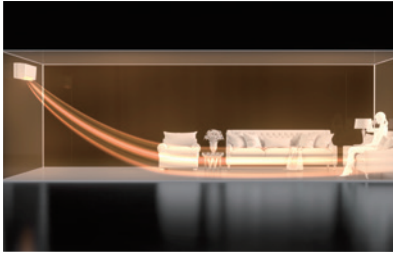

### Eco Mode

Suppresses a sharp increase in energy consumption by a gradual start-up operation.

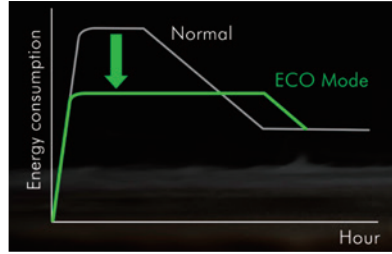

### Quiet Mode

Lowers operation noise level, creating a quieter and peaceful environment.



## Built-in Wi-Fi & App Control

Indoor unit is equipped with Wi-Fi interface which allows you to access MELCloud app, providing you with a flexible control of air conditioner on your smartphone, tablets, and PC.



## Easy Wi-Fi Set Up

You can easily connect Wi-Fi adaptor in the indoor unit and your local router with just a simple operation of remote controller.

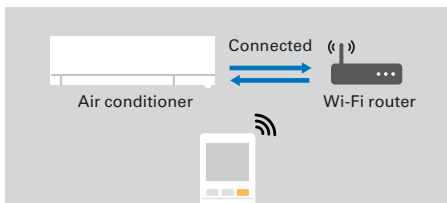

## Remote Controller with Backlight

The remote controller screen is equipped with LED backlight. The luminous screen allows you to check the setting easily even in the dark.



## Back Plate with a Hole

With a hole as default in the center of the back plate, the piping can be easily taken out from the back. The edge of the hole is reinforced to ensure the strength.



The edge of the hole is reinforced to ensure the strength.

## Spacer

A part of the packing material can be used as a spacer to lift indoor unit during the left-side piping work, which makes stable installation work possible.

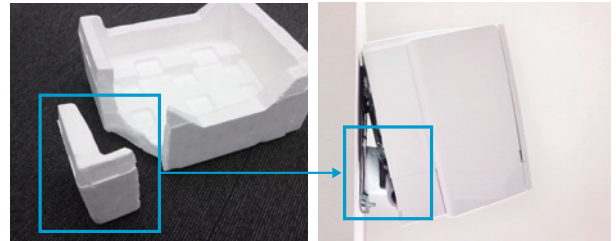

## Bottom Removable Structure

The corner box and the bottom panel are individually removable, and it makes easy to insert tools even in the case of left-side piping.



## Easy Plugging/Unplugging of Drain Hose

One-touch structure with screw-free claw fixing. Easy to plug and unplug the drain hose when changing on the left and right.





# MSZ-RW SERIES



## Indoor Unit / Remote Controller

<White>



MSZ-RW25/35/50VG

## Outdoor Unit



MUZ-RW25/35VGHZ



MUZ-RW50VGHZ

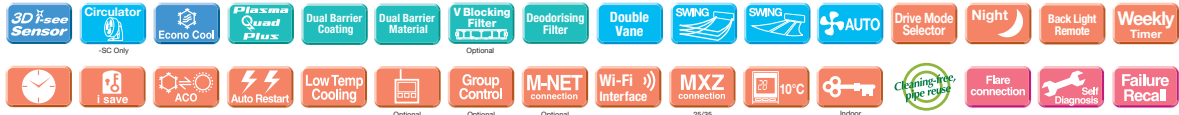

Type		Inverter Heat Pump				
Indoor Unit		MSZ-RW25VG	MSZ-RW35VG	MSZ-RW50VG		
Outdoor Unit		MUZ-RW25VGHZ	MUZ-RW35VGHZ	MUZ-RW50VGHZ		
Refrigerant		R32 <sup>(*)1</sup>				
Power Supply		Outdoor Power supply				
Source		230/Single/50				
Outdoor (V/Phase/Hz)						
Cooling	Design Load	kW	2.5	3.5	5.0	
	Annual Electricity Consumption <sup>(*)2</sup>	kWh/a	78	130	230	
	SEER <sup>(*)4</sup>	Energy Efficiency Class		11.2	9.4	7.6
				A+++	A+++	A++
	Capacity	Rated	kW	2.5	3.5	5.0
		Min - Max	kW	0.9 - 3.5	1.0 - 4.0	1.4 - 5.8
	Total Input	Rated	kW	0.435	0.770	1.380
Heating (Average Season) <sup>(*)5</sup>	Design Load	kW	3.2	4.0	6.0	
	Declared Capacity	at reference design temperature	kW	3.2 (-10°C)	4.0 (-10°C)	6.0 (-10°C)
		at bivalent temperature	kW	3.2 (-10°C)	4.0 (-10°C)	6.0 (-10°C)
		at operation limit temperature	kW	2.6 (-25°C)	2.6 (-25°C)	4.0 (-25°C)
	Back Up Heating Capacity	kW	0.0	0.0	0.0	
	Annual Electricity Consumption <sup>(*)2</sup>	kWh/a	856	1097	1800	
	SCOP <sup>(*)4</sup>	Energy Efficiency Class		5.2	5.1	4.6
				A+++	A+++	A++
Capacity	Rated	kW	3.2	4.0	6.0	
Min - Max	kW	0.8 - 6.3	1.1 - 7.0	1.8 - 8.7		
Total Input	Rated	kW	0.580	0.810	1.450	
Operating Current (max)		A	9.8	11.2	15.2	
Indoor Unit	Input	Rated	kW	0.021	0.022	0.041
	Operating Current (max)		A	0.21	0.22	0.37
	Dimensions		H x W x D	mm	305 - 998 - 247	305 - 998 - 247
	Weight		kg	14.5	14.5	14.5
	Air Volume (SLo-Lo-Mid-Hi-SHi <sup>(*)3</sup> )	Cooling	m <sup>3</sup> /min	5.1 - 6.5 - 9.0 - 11.5 - 13.7	5.1 - 6.9 - 9.0 - 11.5 - 14.1	7.8 - 9.5 - 11.1 - 13.1 - 16.2
		Heating	m <sup>3</sup> /min	5.1 - 7.8 - 9.5 - 11.7 - 14.1	5.1 - 7.8 - 9.5 - 11.7 - 14.5	7.8 - 10.7 - 12.5 - 14.7 - 18.2
	Sound Level (SPL) (SLo-Lo-Mid-Hi-SHi <sup>(*)3</sup> )	Cooling	dB(A)	19 - 23 - 29 - 36 - 42	19 - 24 - 29 - 36 - 43	26 - 30 - 34 - 39 - 45
		Heating	dB(A)	19 - 25 - 30 - 36 - 41	19 - 25 - 30 - 36 - 42	25 - 32 - 37 - 41 - 46
	Sound Level (PWL)		dB(A)	58	59	59
	Dimensions		H x W x D	mm	714 - 800 - 285	880 - 840 - 330
Weight		kg	39.5	40	54	
Air Volume	Cooling	m <sup>3</sup> /min	35.1	37.8	49.3	
	Heating	m <sup>3</sup> /min	37.8	37.8	55.6	
Sound Level (SPL)	Cooling	dB(A)	46	49	51	
	Heating	dB(A)	49	50	54	
Sound Level (PWL)		dB(A)	60	61	64	
Operating Current (max)		A	9.6	11.0	14.8	
Breaker Size		A	10	12	16	
Ext. Piping	Diameter		Liquid / Gas	mm	6.35/9.52	6.35/9.52
	Max. Length		Out-In	m	20	30
	Max. Height		Out-In	m	12	15
Guaranteed Operating Range [Outdoor]		Cooling	°C	-10 ~ +46	-10 ~ +46	-10 ~ +46
		Heating	°C	-30 ~ +24	-30 ~ +24	-30 ~ +24

(\*)1 Refrigerant leakage contributes to climate change. Refrigerant with lower global warming potential (GWP) would contribute less to global warming than a refrigerant with higher GWP, if leaked to the atmosphere. This appliance contains a refrigerant fluid with a GWP equal to 675. This means that if 1 kg of this refrigerant fluid would be leaked to the atmosphere, the impact on global warming would be 1975 times higher than 1 kg of CO<sub>2</sub> over a period of 100 years. Never try to interfere with the refrigerant circuit yourself or disassemble the product yourself and always ask a professional.

(\*)2 Energy consumption based on standard test results. Actual energy consumption will depend on how the appliance is used and where it is located.

(\*)3 SHi: Super High

(\*)4 SEER, SCOP and other related description are based on COMMISSION DELEGATED REGULATION (EU) No.626/2011. The temperature conditions for calculating SCOP are based on 'Average Season'.

(\*)5 Please see page 53-54 for heating (warmer season) specifications.

MSZ-LN18/25/35/50/60VG2

**R32**  
Single / MXZ, PUMY  
**R410A**  
PUMY



**GOOD DESIGN AWARD 2016**  
**BEST 100**

# MSZ-LN SERIES



Developed to complement modern interior room décor, the LN Series is available in four colours specially chosen to blend in naturally wherever installed. Not only the sophisticated design, but also the optimum energy efficiency and operational comfort add even more value to this series.

## Luminous and Luxurious Design

Natural White, Pearl White, Ruby Red, and Onyx Black. LN Series indoor units are available in four colours to match various lifestyles. The appearance of the indoor unit differs depending on the lighting in the room, attracting the attention of everyone that enters the room.

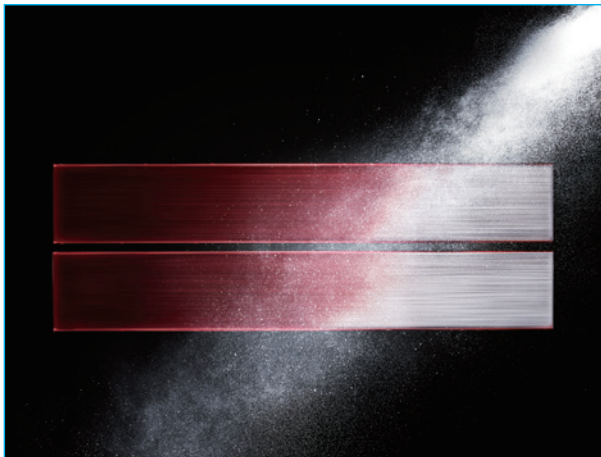

Master craftsmanship painting technology has resulted in a refined design, giving the finish deep colour and a premium quality feel.



Pearl White blends in with any interior.



Ruby Red gives an accent to the room, affording timeless elegance to sophisticated interiors.

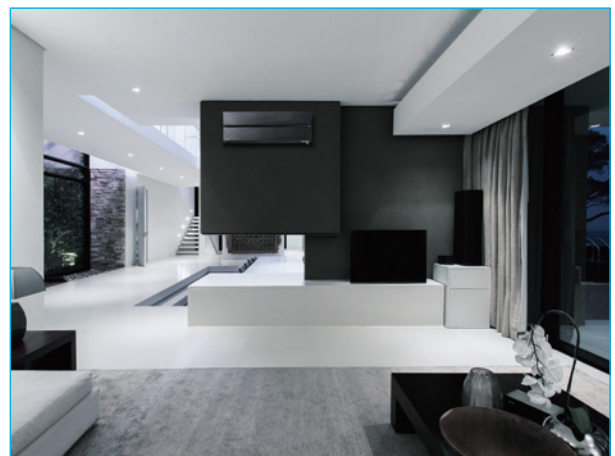

Onyx Black matches darker interiors, creating a comfortable environment.

## LED Backlight Remote Controller

Not only the indoor units, but also the wireless remote controllers come in four colours as well. Each remote controller matches the indoor unit. Even the textures are the same.

The setting can be easily checked in the dark thanks to LED backlight.



Pearl White



Ruby Red



Onyx Black



Natural White

## High Energy Efficiency



Optimum cooling/heating performance is another feature for the LN series. Models from capacities 25 to 50 have achieved the "Rank A+++" for SEER, and models for capacities 25 and 35 have achieved the "Rank A+++" for SCOP as well.

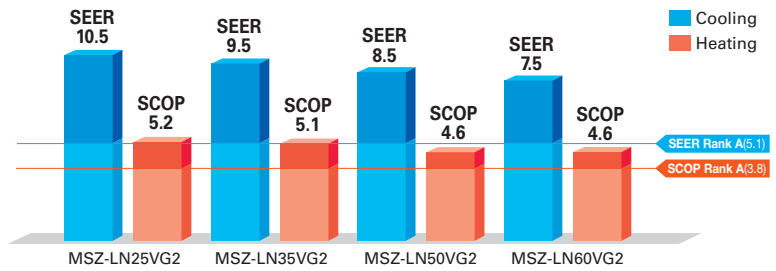

## 3D i-see Sensor

The LN Series is equipped with 3D i-see Sensor, an infrared-ray sensor that measures the temperature at distant positions. While moving to the left and right, eight vertically arranged sensor elements analyze the room temperature in three dimensions. This detailed analysis makes it possible to judge where people are in the room, thus allowing creation of features such as "Indirect airflow," to avoid airflow hitting people directly, and "direct airflow" to deliver airflow to where people are.

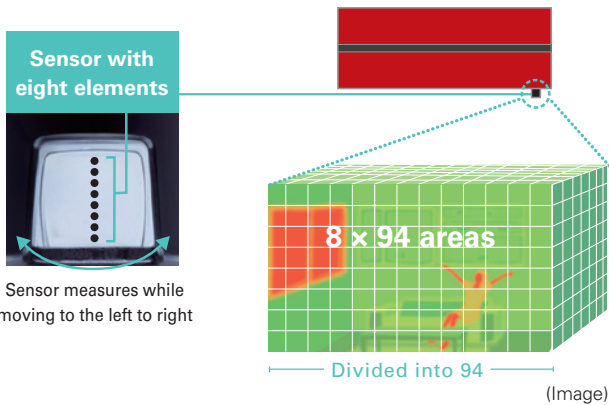

### Indirect Airflow

The indirect airflow setting can be used when the flow of air feels too strong or direct. For example, it can be used during cooling to avert airflow and prevent body temperature from becoming excessively cooled.

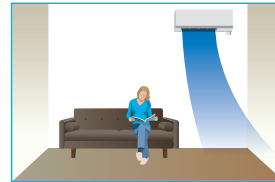

### Direct Airflow

This setting can be used to directly target airflow at people such as for immediate comfort when coming indoors on a hot (cold) day.

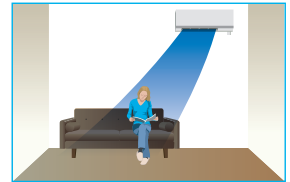

### Even Airflow \*LN Series only

Normal swing mode

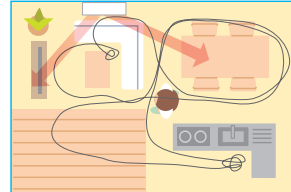

### Even airflow mode

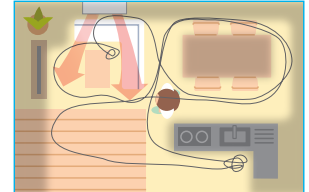

The airflow is distributed equally throughout the room, even to spaces where there is no human movement.

The 3D i-see sensor memorizes human movement and furniture positions, and efficiently distributes airflow.

### No occupancy energy-saving mode

The sensors detect whether there are people in the room. When no-one is in the room, the unit automatically switches to energy-saving mode.

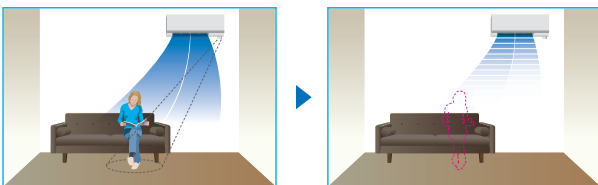

The "3D i-see Sensor" detects people's absence and the power consumption is automatically reduced approximately 10% after 10 minutes and 20% after 60 minutes.

### No occupancy Auto-OFF mode \*LN Series only

The sensors detect whether or not there are people in the room. When there is no one in the room, the unit turns off automatically.

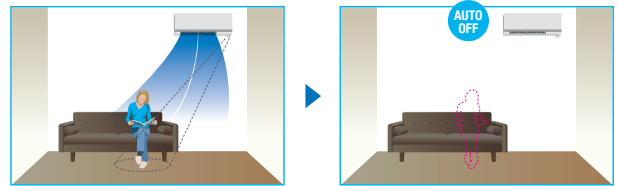

## Circulator Operation

(MSZ-LN18/25/35/50/60VG-SC Scandinavian model)

In case the indoor temperature reaches the setting temperature, the outdoor unit stops and the indoor unit starts FAN operation to circulate the indoor air.

The outdoor unit starts operation automatically when the indoor temperature drops below the setting temperature.

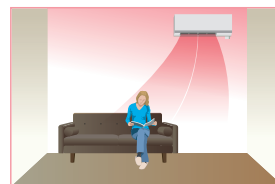

If the heating operation is continued, the warm air is formed around ceiling.

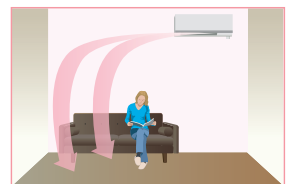

This operation can help to circulate and rene warm air.

# Plasma Quad Plus

Plasma Quad Plus is a plasma-based filter system that effectively removes six kinds of air pollutants. Plasma Quad Plus captures mold and allergens more effectively than Plasma Quad. It can also capture PM2.5 and particles smaller than 2.5µm, creating healthy living spaces for all.

## Bacteria

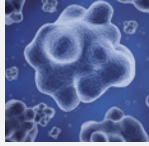

Test results have confirmed that Plasma Quad Plus neutralizes 99% of bacteria in 162 minutes in a 25m<sup>3</sup> test space.

<Test No.> KRCEs-Bio. Test Report No. 2016-0118

## Viruses

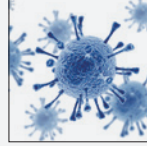

Test results have confirmed that Plasma Quad Plus neutralizes 99% of virus particles in 72 minutes in a 25m<sup>3</sup> test space.

<Test No.> vrc.center, SMC No. 28-002

## Molds

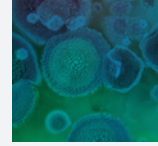

Test results have confirmed that Plasma Quad Plus neutralizes 99% of mold in 135 minutes in a 25m<sup>3</sup> test space.

<Test No.> Japan Food Research Laboratories Test Report No. 16069353001-0201

## Allergens



In a test, air containing cat fur and pollen was passed through the air cleaning device at the low airflow setting. Before and after measurements confirm that Plasma Quad Plus neutralizes 98% of cat fur and pollen.

<Test No.> ITEA Report No. T1606028

## PM2.5

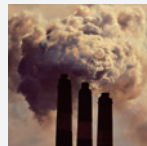

Test results have confirmed that Plasma Quad Plus removes 99% of PM2.5 in 145 minutes in a 28m<sup>3</sup> test space.

<In-company investigation>

## Dust

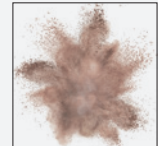

Test results have confirmed that Plasma Quad Plus removes 99.7% of dust and mites.

<Test No.> ITEA Report No. T1606028

Model	Name	Method	Bacteria	Viruses	Molds	Allergens	Dust	PM2.5*
FH Series	Plasma Quad	One-Stage Plasma	A	A	B	B	C	
LN Series	Plasma Quad Plus	Two-Stage Plasma	A	A	A	A	A	A

A: Highly effective  
B: Effective  
C: Partially effective

\*PM2.5:  
Particles smaller than 2.5µm

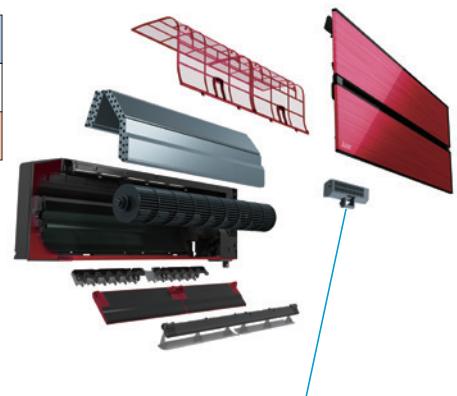

## Image of Plasma Quad Plus

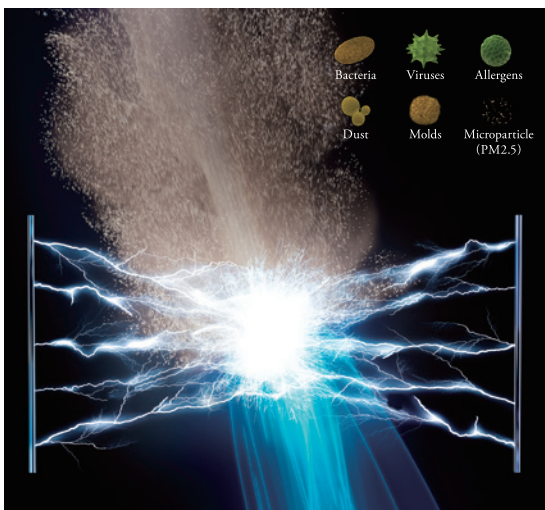

## Principle of Plasma Quad Plus

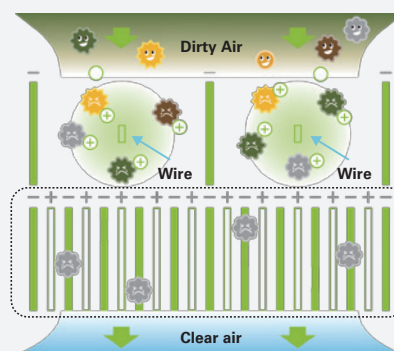

- Dust, PM2.5
- Viruses
- Bacteria
- Mold
- Allergens

### 1st stage

- Make plasma.
- Break mold and allergens. Inhibit viruses.
- Dust and PM2.5 given an electrical charge (+).

### 2nd stage

- Make a strong electrical field.
- The charged dust and PM2.5 (+) are absorbed in the strong electrical field (-).



# Dual Barrier Coating

A two-barrier coating prevents dust and greasy dirt from getting into the air conditioner.

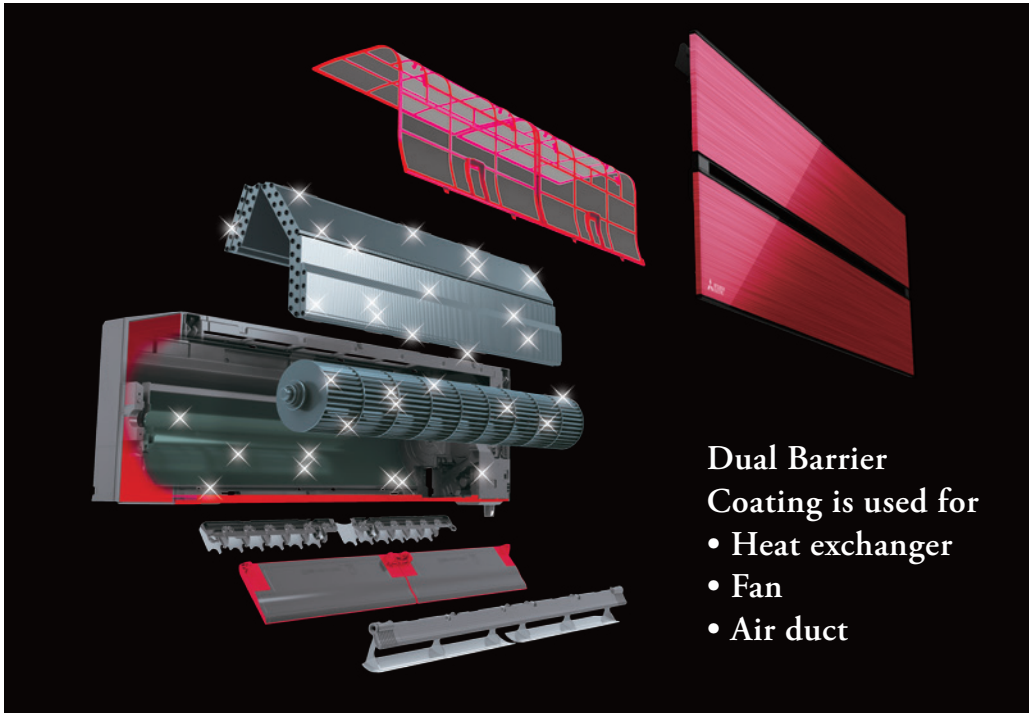

**SIAA** <sup>※1</sup>  
**Anti Fungus**  
 JP0512075X0001C  
 (Fan, Air duct)

## State-of-the-art coating technology

Dirt is generally classified into two groups: hydrophilic dirt such as fiber dust and sand dust, and hydrophobic dirt such as oil and cigarette smoke. Mitsubishi Electric's dual barrier coating works as a two-barrier coating that prevent hydrophilic dirt penetration and "hydrophilic particles" that prevent hydrophobic dirt from getting into the air conditioner. This dual coating on the inner surface keeps the air conditioner clean year-round.

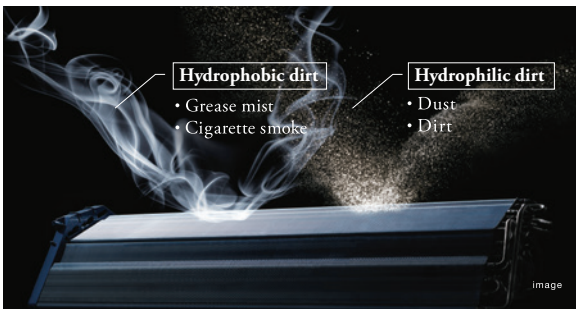

### Comparison of dirt on heat exchanger, fan and air duct (in-house comparison)

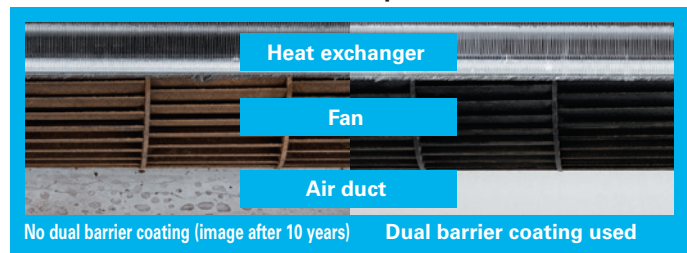

### The inside of the indoor unit gets dirty after many years of usage.

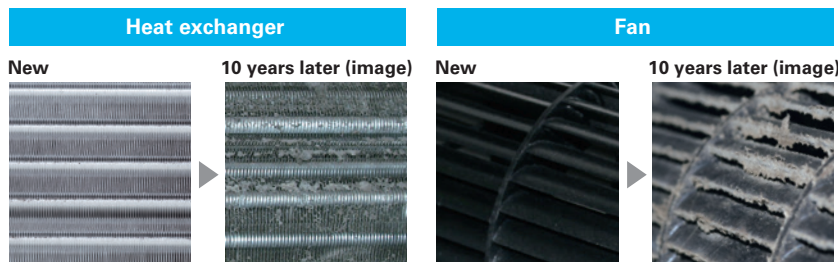

### Consequences when the inside of the indoor unit is left dirty

- Deterioration in energy efficiency
- Musty smell from the unit

※1 Verified by SIAA test method (JIS Z 2911) with No. JP0501014A0002O on SIAA antifungal agent positive list. Antifungal effect depends on the working environment. Fungicides comply with the SIAA safety criteria.  
 What is SIAA? [https://www.kohkin.net/en\\_index/en\\_siaa.html](https://www.kohkin.net/en_index/en_siaa.html)

## Double Flap

The vanes create various airflows to make each person in the room comfortable. Not only the horizontal vanes, but also the vertical vanes move independently, eliminating hot spots or cold spots throughout the room.



## Night Mode

When Night Mode is activated using the wireless remote controller, air conditioner operation will switch to the following settings.

- The brightness of the operation indicator lamp will become dimmer.
- The beeping sound will be disabled.
- The outdoor operating noise will drop to 3dB lower than the rated operating noise specification.

\*The cooling/heating capacity may drop.

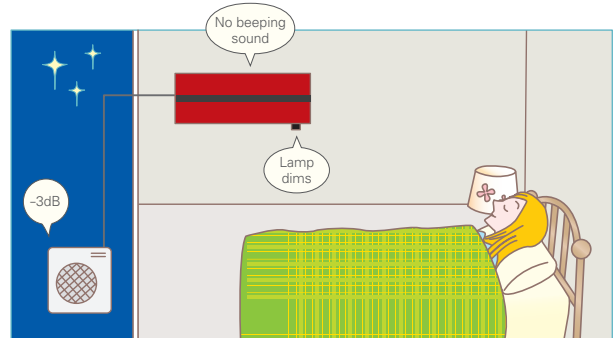

## 10°C Heating

During heating operation, the temperature can be set in 1°C increments down to 10°C.

This function can also be used with the Weekly Timer setting.

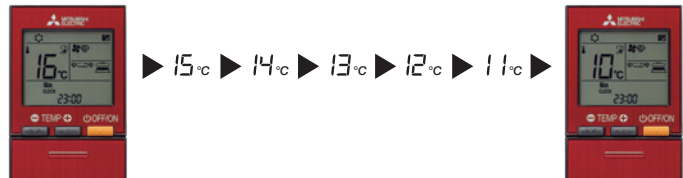

## Quiet Operation

The indoor unit noise level is as low as 19dB for LN25/35 models, offering a peaceful inside environment.

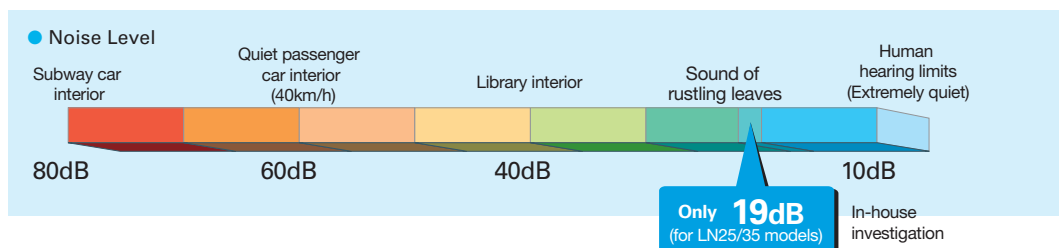

## Built-in Wi-Fi Interface

The indoor unit is equipped with a Wi-Fi Interface inside an exclusive pocket in the unit.

This eliminates the need to install a Wi-Fi interface, and also contributes to the beautiful appearance since the interface is hidden.

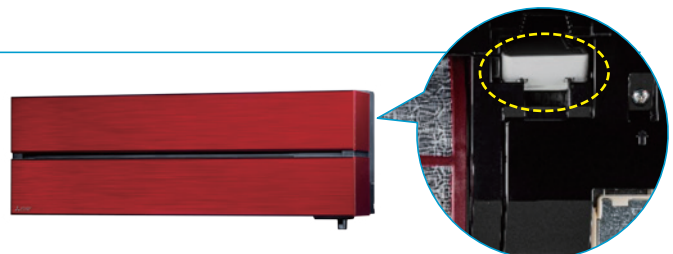

# LN VGHZ SERIES

R32 Single / MXZ, PUMY R410A PUMY

Unlike conventional air conditioning systems, the LN Series don't lose heating capacity when it's cold outside. Original technologies ensure excellent heating performance under extremely low outdoor temperatures and an impressive guaranteed operating range.

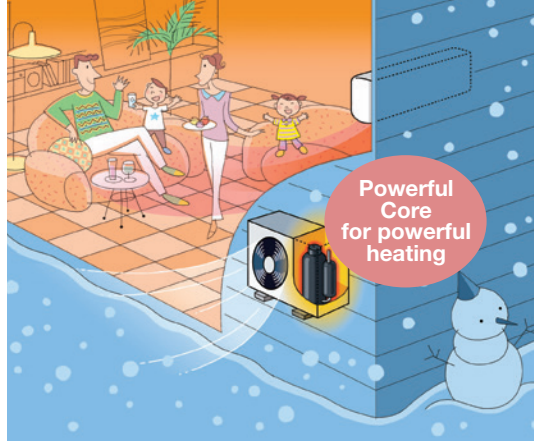

MSZ-LN25/35/50VG2(W)(V)(R)(B)

## Unparalleled Heating Performance

LN Series outdoor units are equipped with a high-output compressor that provides enhanced heating performance under low outdoor temperatures. The heating operation range is extended down to -25°C.

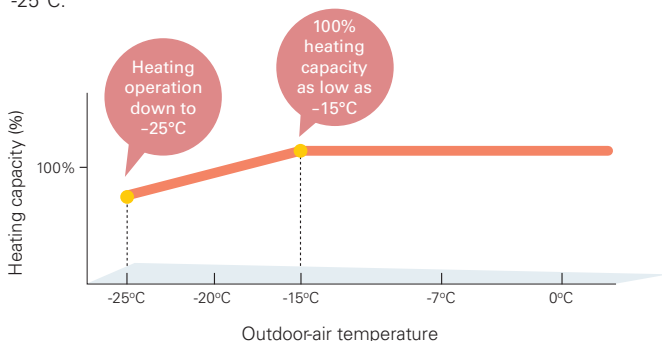

## Operating Range

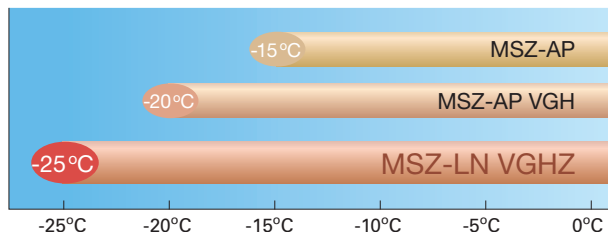

## Declared Capacity (at reference design temperature)

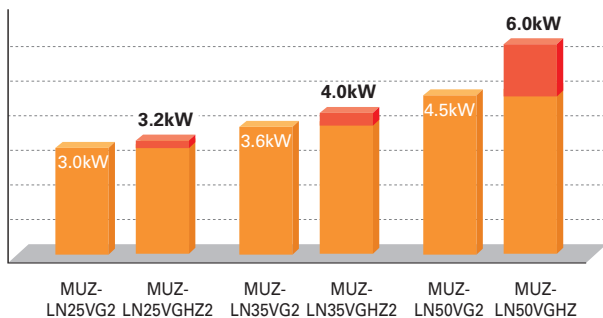

## High Energy Efficiency – Energy Rank of A+ or higher for All Models



With indoor units that combine functionality, design and capacity and outdoor units equipped with a high-efficiency compressor, the MUZ-LN VGHZ simultaneously achieves high heating capacity and energy-saving performance.

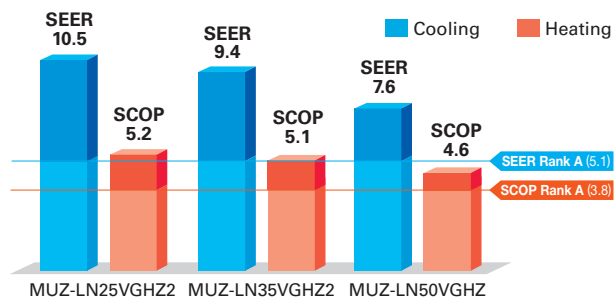

## Freeze-prevention Heater Equipped as Standard

The Freeze-prevention heater restricts lowered capacity and operation shutdowns caused by the drain water freezing. This supports stable operation in low-temperature environments.

Can operate at outside-air temperature of -25°C



Without Freeze-prevention heater

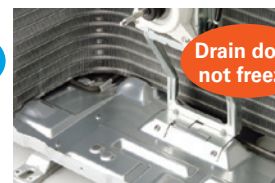

With Freeze-prevention heater

\*Image is for illustration purposes. The actual performance depends on outdoor temperature.

## Compact, Powerful Compressor

A special manufacturing technology, "Heat Caulking Fixing Method," has been introduced to reduce compressor size while maintaining a high compressor output. This technology enables the installation of a powerful compressor in compact MUZ outdoor units. As a result, excellent heating performance is achieved when operating in cold outdoor environments.

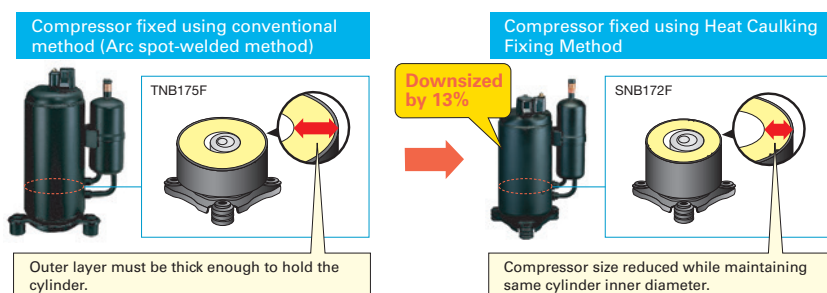

# MSZ-LN SERIES



## Indoor Unit / Remote Controller

R32 PUMY R410A



<Pearl White>



MSZ-LN18/25/35/50/60VG2V

<Ruby Red>



MSZ-LN18/25/35/50/60VG2R

<Natural White>



MSZ-LN18/25/35/50/60VG2W

<Onyx Black>



MSZ-LN18/25/35/50/60VG2B

## Outdoor Unit

R32



MUZ-LN25/35VG2



MUZ-LN50VG2



MUZ-LN60VG2



Type			Inverter Heat Pump						
Indoor Unit			MSZ-LN18VG2	MSZ-LN25VG2	MSZ-LN35VG2	MSZ-LN50VG2	MSZ-LN60VG2		
Outdoor Unit			for MXZ connection	MUZ-LN25VG2	MUZ-LN35VG2	MUZ-LN50VG2	MUZ-LN60VG2		
Refrigerant			Single: R32 <sup>(1)</sup> / Multi: R410A or R32 <sup>(1)</sup>						
Power Source	Source		Outdoor Power Supply						
Supply	Outdoor (V / Phase / Hz)		230 / Single / 50						
Cooling	Design load	kW	–	2.5	3.5	5.0	6.1		
	Annual electricity consumption <sup>(2)</sup>	kWh/a	–	83	129	205	285		
	SEER <sup>(4)</sup>	–	–	10.5	9.5	8.5	7.5		
	Capacity	Energy efficiency class		–	A+++	A+++	A+++	A++	
		Rated	kW	–	2.5	3.5	5.0	6.1	
Heating (Average Season) <sup>(5)</sup>	Declared Capacity	kW	–	3.0 (-10°C)	3.6 (-10°C)	4.5 (-10°C)	6.0 (-10°C)		
	Back up heating capacity	at reference design temperature	kW	–	3.0 (-10°C)	3.6 (-10°C)	4.5 (-10°C)	6.0 (-10°C)	
		at operation limit temperature	kW	–	2.5 (-15°C)	3.2 (-15°C)	4.2 (-15°C)	6.0 (-15°C)	
	Annual electricity consumption <sup>(2)</sup>	kWh/a	–	807	987	1369	1816		
	SCOP <sup>(4)</sup>	–	–	5.2	5.1	4.6	4.6		
Operating Current (Max)	Energy efficiency class		–	A+++	A+++	A++	A++		
	Rated	kW	–	3.2	4.0	6.0	6.8		
	Min-Max	kW	–	0.7 - 5.4	0.9 - 6.3	1.0 - 8.2	1.8 - 9.3		
	Total Input	kW	–	0.600	0.820	1.480	1.810		
	Rated	kW	–	–	–	–	–		
Indoor Unit	Operating Current (Max)	A	–	7.1	9.9	13.9	15.2		
	Input	kW	0.027	0.027	0.027	0.034	0.040		
	Operating Current (Max)	A	0.3	0.3	0.3	0.4	0.4		
	Dimensions	H*W*D	mm	307-890-233	307-890-233	307-890-233	307-890-233		
	Weight	kg	14.5 (W) 15.5 (V, R, B)	14.5 (W) 15.5 (V, R, B)	14.5 (W) 15.5 (V, R, B)	15 (W) 16 (V, R, B)	15 (W) 16 (V, R, B)		
	Air Volume (SL-Lo-Mid-Hi-SH) <sup>(3)</sup>	Cooling	m <sup>3</sup> /min	4.7 - 5.9 - 7.1 - 9.2 - 12.4	4.7 - 5.9 - 7.1 - 9.2 - 12.4	4.7 - 5.9 - 7.1 - 9.2 - 13.0	5.7 - 7.6 - 8.8 - 10.6 - 13.9	7.1 - 8.8 - 10.6 - 12.7 - 15.7	
		Heating	m <sup>3</sup> /min	4.5 - 6.6 - 7.5 - 11.0 - 13.9	4.5 - 6.6 - 7.5 - 11.0 - 13.9	4.5 - 6.6 - 7.5 - 11.0 - 13.9	5.4 - 6.4 - 8.5 - 10.7 - 15.7	6.6 - 9.5 - 11.5 - 13.6 - 15.7	
	Sound Level (SPL) (SL-Lo-Mid-Hi-SH) <sup>(3)</sup>	Cooling	dB(A)	19 - 23 - 29 - 36 - 42	19 - 23 - 29 - 36 - 42	19 - 24 - 29 - 36 - 43	27 - 31 - 35 - 39 - 46	29 - 37 - 41 - 45 - 49	
		Heating	dB(A)	19 - 24 - 29 - 38 - 45	19 - 24 - 29 - 38 - 45	19 - 24 - 29 - 38 - 45	25 - 29 - 34 - 39 - 47	29 - 37 - 41 - 45 - 49	
	Sound Level (PWL)	Cooling	dB(A)	58	58	59	60	65	
	Outdoor Unit	Dimensions	H*W*D	mm	550-800-285	550-800-285	714-800-285	880-840-330	
		Weight	kg	–	33	40	40	53	
		Air Volume	Cooling	m <sup>3</sup> /min	–	34.3	34.3	40.0	48.8
			Heating	m <sup>3</sup> /min	–	32.7	32.7	40.5	55.0
		Sound Level (SPL)	Cooling	dB(A)	–	46	49	51	55
Heating	dB(A)		–	49	50	54	55		
Sound Level (PWL)	Cooling	dB(A)	–	60	61	64	65		
Operating Current (Max)	A	–	6.8	9.6	13.5	14.8			
Breaker Size	A	–	10	10	16	16			
Ext. Piping	Diameter	Liquid/Gas	mm	6.35/9.52	6.35/9.52	6.35/9.52	6.35/12.7		
	Max.Length	Out-In	m	–	20	30	30		
	Max.Height	Out-In	m	–	12	12	15		
Guaranteed Operating Range (Outdoor)	Cooling	°C	–	-10 ~ +46	-10 ~ +46	-10 ~ +46	-10 ~ +46		
	Heating	°C	–	-15 ~ +24	-15 ~ +24	-15 ~ +24	-15 ~ +24		

(1) Refrigerant leakage contributes to climate change. Refrigerant with lower global warming potential (GWP) would contribute less to global warming than a refrigerant with higher GWP, if leaked to the atmosphere. This appliance contains a refrigerant fluid with a GWP equal to 550. This means that if 1 kg of this refrigerant fluid would be leaked to the atmosphere, the impact on global warming would be 550 times higher than 1 kg of CO<sub>2</sub> over a period of 100 years. Never try to interfere with the refrigerant circuit yourself or disassemble the product yourself and always ask a professional.

The GWP of R32 is 675 in the IPCC 4th Assessment Report.

(2) Energy consumption based on standard test results. Actual energy consumption will depend on how the appliance is used and where it is located.

(3) SHi: Super High

(4) SEER, SCOP and other related description are based on COMMISSION DELEGATED REGULATION (EU) No.626/2011. The temperature conditions for calculating SCOP are based on "Average Season".

(5) Please see page 53-54 for heating (warmer season) specifications.



# MSZ-LN VGHZ SERIES



## Indoor Unit / Remote Controller



<Pearl White>



MSZ-LN25/35/50VG2V

<Ruby Red>



MSZ-LN25/35/50VG2R

<Natural White>



MSZ-LN25/35/50VG2W

<Onyx Black>



MSZ-LN25/35/50VG2B

## Outdoor Unit



MUZ-LN25/35VGHZ2



MUZ-LN50VGHZ2



Type		Inverter Heat Pump					
Indoor Unit		MSZ-LN25VG2(W)(V)(R)(B)	MSZ-LN35VG2(W)(V)(R)(B)	MSZ-LN50VG2(W)(V)(R)(B)			
Outdoor Unit		MUZ-LN25VGHZ2	MUZ-LN35VGHZ2	MUZ-LN50VGHZ2			
Refrigerant		R32 <sup>(*)1</sup>					
Power Supply		Outdoor Power supply					
Outdoor (V/Phase/Hz)		230/Single/50					
Cooling	Design Load	kW	2.5	3.5	5.0		
	Annual Electricity Consumption <sup>(*)2</sup>	kWh/a	83	130	230		
	SEER <sup>(*)4</sup>	Energy Efficiency Class		10.5	9.4	7.6	
		Energy Efficiency Class		A+++	A+++	A++	
	Capacity	Rated	kW	2.5	3.5	5.0	
		Min - Max	kW	0.8 - 3.5	0.8 - 4.0	1.4 - 5.8	
	Total Input	Rated	kW	0.485	0.820	1.380	
Heating (Average Season) <sup>(*)5</sup>	Design Load	kW	3.2 (-10°C)	4.0 (-10°C)	6.0 (-10°C)		
	Declared Capacity	at reference design temperature	kW	3.2 (-10°C)	4.0 (-10°C)	6.0 (-10°C)	
		at bivalent temperature	kW	3.2 (-10°C)	4.0 (-10°C)	6.0 (-10°C)	
		at operation limit temperature	kW	2.3 (-25°C)	3.1 (-25°C)	4.7 (-25°C)	
	Back Up Heating Capacity	kW	0.0 (-10°C)	0.0 (-10°C)	0.0 (-10°C)		
	Annual Electricity Consumption <sup>(*)2</sup>	kWh/a	861	1098	1826		
	SCOP <sup>(*)4</sup>	Energy Efficiency Class		5.2	5.1	4.6	
		Energy Efficiency Class		A+++	A+++	A++	
	Capacity	Rated	kW	3.2	4.0	6.0	
		Min - Max	kW	0.8 - 6.3	0.9 - 6.6	1.8 - 8.7	
Total Input	Rated	kW	0.600	0.820	1.480		
Operating Current (max)		A	9.9	10.5	15.2		
Indoor Unit	Input	Rated	kW	0.027	0.027	0.034	
	Operating Current (max)		A	0.3	0.3	0.4	
	Dimensions		H x W x D	mm	307 - 890 - 233	307 - 890 - 233	307 - 890 - 233
	Weight		kg	15.5	15.5	15.5	
	Air Volume (SLo-Lo-Mid-Hi-SHi <sup>(*)3</sup> )	Cooling	m <sup>3</sup> /min	4.3 - 5.8 - 7.1 - 8.8 - 11.9	4.3 - 5.8 - 7.1 - 8.8 - 12.8	5.7 - 7.6 - 8.9 - 10.6 - 13.9	
		Heating	m <sup>3</sup> /min	4.0 - 5.7 - 7.1 - 8.5 - 14.4	4.3 - 5.7 - 7.1 - 8.5 - 13.7	5.4 - 6.4 - 8.5 - 10.7 - 15.7	
	Sound Level (SPL) (SLo-Lo-Mid-Hi-SHi <sup>(*)3</sup> )	Cooling	dB(A)	19 - 23 - 29 - 36 - 42	19 - 24 - 29 - 36 - 43	27 - 31 - 35 - 39 - 46	
		Heating	dB(A)	19 - 24 - 29 - 36 - 45	19 - 24 - 29 - 36 - 45	25 - 29 - 34 - 39 - 47	
	Sound Level (PWL)		dB(A)	58	58	60	
	Outdoor Unit	Dimensions		H x W x D	mm	550 - 800 - 285	550 - 800 - 285
Weight		kg	35	36	53		
Air Volume		Cooling	m <sup>3</sup> /min	31.4	33.8	48.8	
		Heating	m <sup>3</sup> /min	27.4	27.4	55.0	
Sound Level (SPL)		Cooling	dB(A)	46	49	51	
		Heating	dB(A)	49	50	54	
Sound Level (PWL)		dB(A)	60	61	64		
Operating Current (max)		A	9.6	10.2	14.8		
Breaker Size		A	10	12	16		
Ext. Piping	Diameter		Liquid / Gas	mm	6.35/9.52	6.35/9.52	6.35/9.52
	Max. Length		Out-In	m	20	20	30
	Max. Height		Out-In	m	12	12	15
Guaranteed Operating Range [Outdoor]		Cooling	°C	-10 ~ +46	-10 ~ +46	-10 ~ +46	
		Heating	°C	-25 ~ +24	-25 ~ +24	-25 ~ +24	

(\*)1 Refrigerant leakage contributes to climate change. Refrigerant with lower global warming potential (GWP) would contribute less to global warming than a refrigerant with higher GWP, if leaked to the atmosphere. This appliance contains a refrigerant fluid with a GWP equal to 550. This means that if 1 kg of this refrigerant fluid would be leaked to the atmosphere, the impact on global warming would be 550 times higher than 1 kg of CO<sub>2</sub> over a period of 100 years. Never try to interfere with the refrigerant circuit yourself or disassemble the product yourself and always ask a professional. The GWP of R32 is 675 in the IPCC 4th Assessment Report.

(\*)2 Energy consumption based on standard test results. Actual energy consumption will depend on how the appliance is used and where it is located.

(\*)3 SHi: Super High

(\*)4 SEER, SCOP and other related description are based on COMMISSION DELEGATED REGULATION (EU) No.626/2011. The temperature conditions for calculating SCOP are based on "Average Season".

(\*)5 Please see page 53-54 for heating (warmer season/colder season) specifications.

# MSZ-AY SERIES

The AY series has an excellent cleanliness feature and ranges to two models: the VGK model comes standard with the V Blocking Filter, which has antiviral, antibacterial, anti-mold, and anti-allergen effects, and the VGKP model comes standard with Plasma Quad Plus, which can collect PM2.5 dust in addition to these effects. The AY series has also been upgraded in terms of quietness, energy efficiency, and ease of installation. Enjoy a comfortable air environment with the AY series.



## High energy saving



The AY series has achieved either the "Rank A+++" or "Rank A++" for SEER and SCOP as energy-savings rating. The high-efficiency air conditioner is eco-friendly and economical.

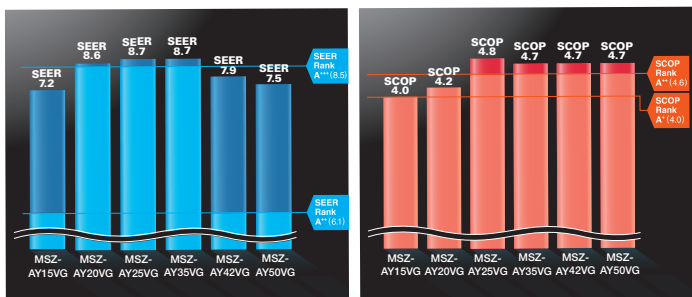

## Matt and Sophisticated Design

The elegant and sophisticated design has been created to fit in any room, with careful attention to detail in the surface finish and panel angles.



### Rounded corners

The rounded corners give a soft impression that blends in with any room.

### Simple and Compact size

While the plasma is built-in, the angle of the curve is carefully designed to maintain the compact unit.

## Widely Ranged Capacities

Compact and stylish models are available.

The wide range of capacities is designed to match a variety of room types. In particular, the 1.5kW and 2.0kW models are ideal for children's rooms, bedrooms, and highly insulated homes.

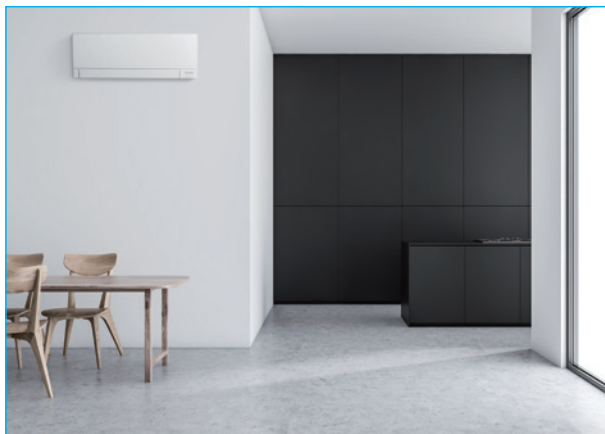

MSZ-AY25/35/42/50VGK(P)



MSZ-AY15/20VGK(P)

# Plasma Quad Plus (only VGKP model)



You can enjoy the clean and safe air by Plasma Quad Plus.

Plasma Quad Plus is a plasma-based filtering system which contributes to a better air quality in your room. Plasma Quad Plus applies a voltage of approximately 6,000 volts to the electrode to generate plasma, effectively removing various kinds of airborne particles such as viruses, bacteria, mold, allergen, dust, and PM2.5.

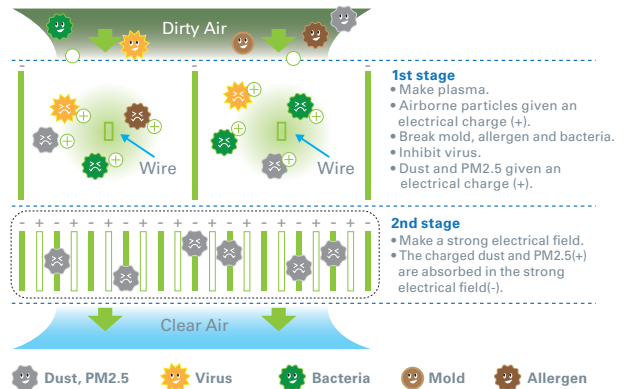

**We have confirmed Plasma Quad Plus inhibits 99% of adhered COVID-19.**

\*Tested Organization: National Hospital Organization Sendai Medical Center, Test Report No: R4-001 Test result: Neutralised 99% of influenza A virus in 210.5 minutes in a 25m<sup>3</sup> test space.

\*Tested Organization: Japan Textile Products Quality and Technology Center, Test Report No: 20KB070569, Tested Materials: SARS-CoV-2, Test Method: Original (The test was conducted on the Plasma Quad device alone, not designed to evaluate product performance.) Test Result: Inhibited 99.8% in 360 minutes. The result without the effect of natural attenuation is 96.3%.

The above test results are for AY25-50. Test results for AY15/20 are on p10.



## V Blocking Filter (only VGK model)

“V Blocking Filter” with antiviral effect inhibits 99% of adhered virus, and other harmful substances, such as bacteria, mold and allergen. Two-layered filter with non-woven fabric and electrostatic filter can effectively capture and remove small particles from the air in your room.

\*Virus Test method: JIS L 1922, Tested Organization: Guangdong Detection Center of Microbiology, Test Report No: 2020FM30156R02D, Test result: 99% neutralized in 24 hours in a Testing Container.

Bacteria Test method: JIS L 1902, Tested Organization: Boken Quality Evaluation Institute, Test Report No: 29020006998-1, Test result: 99% neutralized in 18 hours in a Petri dish.

Mold Test method: JIS Z 2911, Tested Organization: Boken Quality Evaluation Institute, Test Report No: 29020006906-1, Test result: No mold growth was confirmed.

Allergen Test method: ELISA, Tested Organization: Daiwa Chemical Industries Co., Ltd, Test Report No: 2021B267, Test result: 96% neutralized in 24 hours.

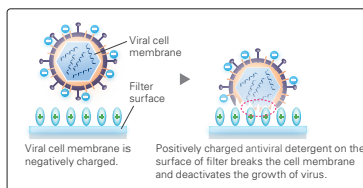

## Dual Barrier Coating

Mitsubishi Electric's Dual Barrier Coating prevents dust and greasy dirt from accumulating on the inner surface of the indoor unit, keeping your air conditioner clean. Hydrophilic material resists oil stains and hydrophobic material resists dust stains.

1 Heat Exchanger		2 Fan		3 Air Duct	
No Dual Barrier Coating used (Image after 10years)	Dual Barrier Coating used	No Dual Barrier Coating used (Image after 10years)	Dual Barrier Coating used	No Dual Barrier Coating used (Image after 10years)	Dual Barrier Coating used

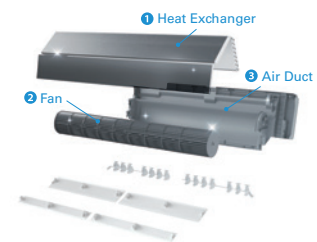

## Self Clean

When Self Clean Mode is activated, fan operation starts after cooling/dry mode. This operation helps to dry inside indoor unit to prevent molds and odors. You can feel the clean air without frequent cleaning by yourself.

1 High humidity inside the unit, which can lead to mold growth and odors.

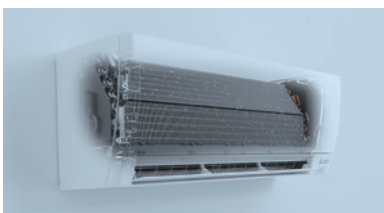

2 Airflow operation suppresses mycelial growth.



3 Maintains clean unit interior.



\*When SELF CLEAN operation is set, it performs for 25 minutes when unit is stopped after COOL/DRY operation. SELF CLEAN operation performs when: COOL/DRY is operated more than 3 minutes. The fan is stopped for the first 3 minutes. Then, the horizontal vane is set to higher than angle 1 and the fan is operated for 25 minutes. To enable this function, press “Self Clean Mode” button on remote controller. (Default setting is OFF)



## Quietness 18dB

### Noiseless 18dB



Quiet, relaxing space is within reach. Operational noise is 18dB (for AY25/35 single connection), which is so quiet that you might even forget the air conditioner is on.



## Night mode

When Night Mode is activated using the wireless remote controller, air conditioner operation will switch to the following settings.

- The brightness of the operation indicator lamp will become dimmer.
- The beeping sound will be disabled.
- The outdoor operating noise will be 3dB lower than the rated operating noise specification.

\*The cooling/heating capacity may drop.

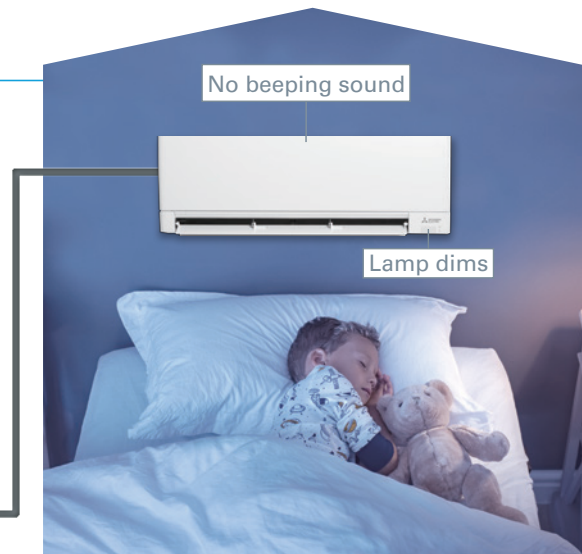

## Wider Heating Operation Range

Mitsubishi Electric technology ensures that the unit will operate even when the outside temperature is down to -20°C for AY20/25/35/42/50 single connection only.

### Wider Heating Operation Range

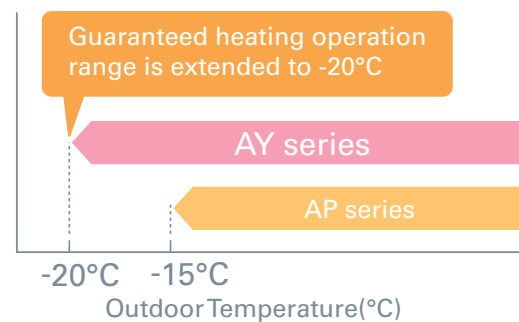

## Outdoor Units for Cold Region

Single split-type outdoor units are available in both standard and heater-equipped units. An electric heater is installed in each unit to prevent freezing in cold outdoor environments.

### Standard Units

### Heater-equipped Units



MUZ-AY25/35/42VG



MUZ-AY50VG



MUZ-AY25/35/42VGH



MUZ-AY50VGH

## Back Plate with a Hole

With a hole as default in the center of the back plate, the piping can be easily taken out from the back. The edge of the hole is reinforced to ensure the strength.

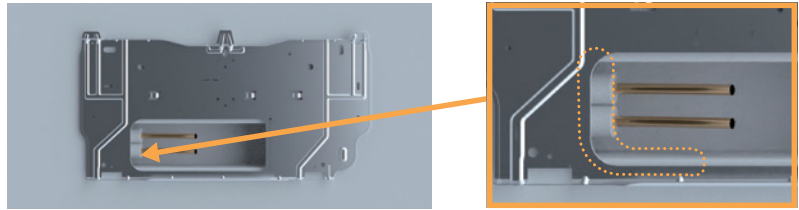

The edge of the hole is reinforced to ensure the strength.

## Spacer

A part of the packing material can be used as a spacer to lift indoor unit during the left-side piping work, which makes stable installation work possible.



## Built-in Wi-Fi & App Control

Indoor unit is equipped with Wi-Fi interface which allows you to access MELCloud app, providing you with a flexible control of air conditioner on your smartphone, tablets, and PC.

[ key control and monitoring features ]

- On/Off
- Check and set driving conditions
- Notification of weather conditions from current location
- Weekly timer set
- Energy consumption check
- Air purification on/off



## Easy Wi-Fi Set Up

You can easily connect Wi-Fi adaptor in the indoor unit and your local router with just a simple operation of remote controller.

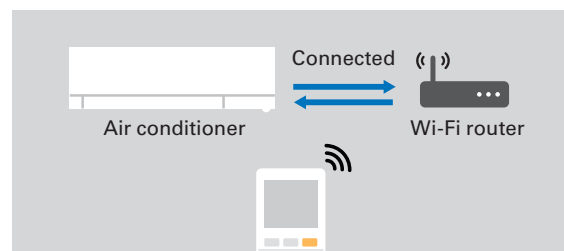

## Remote Controller features

The remote controller screen is equipped with LED back-light. The luminous screen allows you to check the setting easily even in the dark. You can easily connect Wi-Fi adaptor in the indoor unit and your local router with just a simple operation of remote controller.



# MSZ-AP SERIES

Introducing a compact and stylish indoor unit with various capacity, designed to match number of rooms. High performance indoor and outdoor units enabled to achieve "Rank A+++" for SEER. \*MSZ-AP20VG

MSZ-AP60/71VG



GOOD DESIGN  
AWARD 2017



reddot award 2018  
winner

## High energy saving



The classes from the low-capacity 25 to the high-capacity 60, have achieved either the "Rank A+++" or "Rank A++" for SEER and SCOP as energy-savings rating. Our air conditioners are contributing to reduce energy consumption in a wide range.

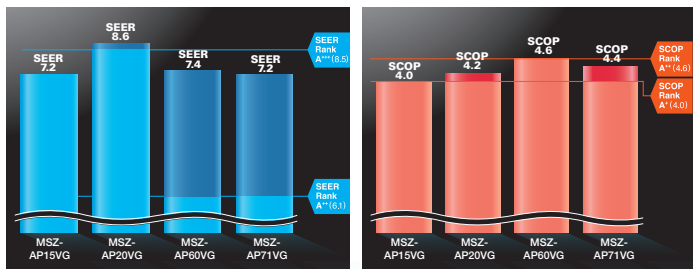

## Large capacity model

Suitable model for large rooms.



## Wide and Long Airflow

The wide and long airflow function is especially beneficial for large spaces, helping to ensure that air is well circulated and reaches every corner of the room.

### Wide Airflow

This unique airflow system distributes air horizontally over a wide-ranging 150° in heating mode and 100° in cooling mode. Simply press the Wide Swing icon on the remote controller to select the desired airflow from seven different patterns.

### Long Airflow

Use this function to ensure that the air-flow circulates to areas far across the room. Press the Long Airflow icon on the remote controller to extend reach up to as far as 12 metres from the unit.

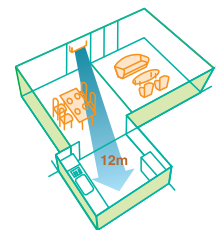

## Evolved comfortable convenience function



**Horizontal Airflow**

The new airflow control which spreads across the ceiling eliminates the uncomfortable drafty feeling.

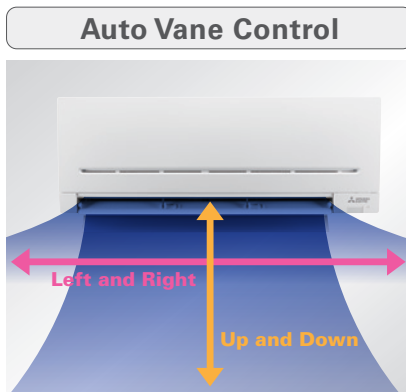

**Auto Vane Control**

Auto vanes can be moved left and right, and up and down using the remote controller.

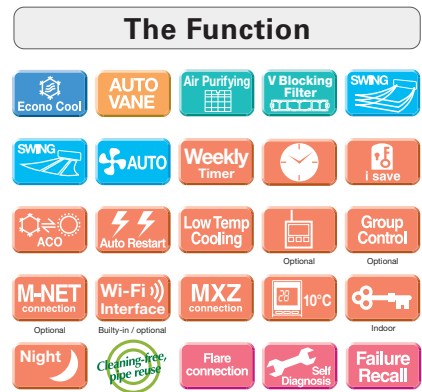

**The Function**

## “Weekly Timer”



Easily set desired temperatures and operation start/stop times to match lifestyle patterns. Reduce wasted energy consumption by using the timer to prevent forgetting to turn off the unit and eliminate temperature setting adjustments.

### ■ Example Operation Pattern (Winter/Heating mode)

	Mon.	Tues.	Wed.	Thurs.	Fri.	Sat.	Sun.
6:00	ON 20°C	ON 20°C	ON 20°C	ON 20°C	ON 20°C	ON 20°C	ON 20°C
8:00	Automatically changes to high-power operation at wake-up time						
10:00							
12:00	OFF	OFF	OFF	OFF	OFF	ON 18°C	ON 18°C
14:00	Automatically turned off during work hours					Midday is warmer, so the temperature is set lower	
16:00							
18:00	ON 20°C	ON 20°C	ON 20°C	ON 20°C	ON 20°C	ON 20°C	ON 20°C
20:00	Automatically turns on, synchronized with arrival at home					Automatically raises temperature setting to match time when outside-air temperature is low	
22:00							
(during sleeping hours)	ON 18°C	ON 18°C	ON 18°C	ON 18°C	ON 18°C	ON 18°C	ON 18°C
	Automatically lowers temperature at bedtime for energy-saving operation at night						

### Settings

**Pattern Settings:** Input up to four settings for each day

**Settings:** •Start/Stop operation •Temperature setting \*The operation mode cannot be set.

### ■ Easy set-up using dedicated buttons



The remote controller is equipped with buttons that are used exclusively for setting the Weekly Timer. Setting operation patterns is easy and quick.

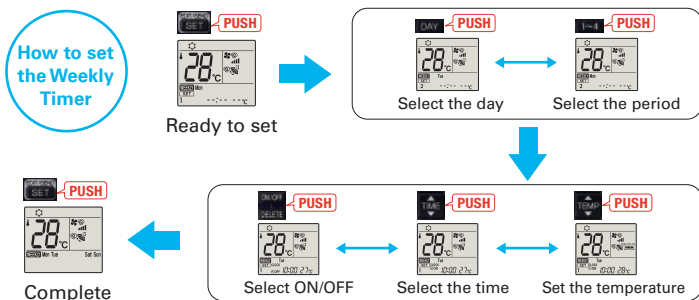
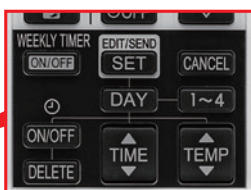

- Start by pushing the “SET” button and follow the instructions to set the desired patterns. Once all of the desired patterns are input, point the top end of the remote controller at the indoor unit and push the “SET” button one more time. (Push the “SET” button only after inputting all of the desired patterns into the remote controller memory. Pushing the “CANCEL” button will end the set-up process without sending the operation patterns to the indoor unit).
- It takes a few seconds to transmit the Weekly Timer operation patterns to the indoor unit. Please continue to point the remote controller at the indoor unit until all data has been sent.
- When “Weekly Timer” is set, temperature can not be set 10°C. (only for 15/20 models)

# MSZ-AY SERIES



## Indoor Unit

R32



MSZ-AY15/20VGK(P)



MSZ-AY25/35/42/50VGK(P)

## Outdoor Unit

R32



MUZ-AY15VG



MUZ-AY20VG



MUZ-AY25/35/42VG(H)



MUZ-AY50VG(H)

## Remote Controller



Type		Inverter Heat Pump											
Indoor Unit		MSZ-AY15VGK(P)	MSZ-AY20VGK(P)	MSZ-AY25VGK(P)	MSZ-AY25VGK(P)	MSZ-AY35VGK(P)	MSZ-AY35VGK(P)	MSZ-AY42VGK(P)	MSZ-AY42VGK(P)	MSZ-AY50VGK(P)	MSZ-AY50VGK(P)		
Outdoor Unit		MUZ-AY15VG	MUZ-AY20VG	MUZ-AY25VG	MUZ-AY25VG(H)	MUZ-AY35VG	MUZ-AY35VG(H)	MUZ-AY42VG	MUZ-AY42VG(H)	MUZ-AY50VG	MUZ-AY50VG(H)		
Refrigerant		R32 <sup>(1)</sup>											
Power Supply	Source	Outdoor Power supply											
	Outdoor (V / Phase / Hz)	230/Single/50											
Cooling	Design load	kW	1.5	2.0	2.5	2.5	3.5	3.5	4.2	4.2	5.0	5.0	
	Annual electricity consumption <sup>(2)</sup>	kWh/a	72	81	100	100	141	141	186	186	232	232	
	SEER <sup>(4)</sup>		7.2	8.6	8.7	8.7	8.7	8.7	7.9	7.9	7.5	7.5	
	Capacity	Rated	kW	1.5	2.0	2.5	2.5	3.5	3.5	4.2	4.2	5.0	5.0
		Min-Max	kW	0.5-2.2	0.6-2.7	0.9-3.4	0.9-3.4	1.1-3.8	1.1-3.8	0.9-4.5	0.9-4.5	1.4-5.4	1.4-5.4
Heating (Average Season) <sup>(5)</sup>	Design load	kW	1.6 (-10°C)	2.3 (-10°C)	2.4 (-10°C)	2.4 (-10°C)	2.9 (-10°C)	2.9 (-10°C)	3.8 (-10°C)	3.8 (-10°C)	4.2 (-10°C)	4.2 (-10°C)	
	Declared Capacity	at reference design temperature	kW	1.6 (-10°C)	2.3 (-10°C)	2.4 (-10°C)	2.4 (-10°C)	2.9 (-10°C)	2.9 (-10°C)	3.8 (-10°C)	3.8 (-10°C)	4.2 (-10°C)	4.2 (-10°C)
		at operation limit temperature	kW	1.6 (-15°C)	1.8 (-20°C)	1.9 (-20°C)	1.9 (-20°C)	2.0 (-20°C)	2.0 (-20°C)	2.7 (-20°C)	2.7 (-20°C)	3.0 (-20°C)	3.0 (-20°C)
	Back up heating capacity	kW	0.0 (-10°C)	0.0 (-10°C)	0.0 (-10°C)	0.0 (-10°C)	0.0 (-10°C)	0.0 (-10°C)	0.0 (-10°C)	0.0 (-10°C)	0.0 (-10°C)	0.0 (-10°C)	
	Annual electricity consumption <sup>(2)</sup>	kWh/a	558	766	697	709	863	880	1131	1146	1248	1265	
	SCOP <sup>(4)</sup>		4.0	4.2	4.8	4.7	4.7	4.6	4.7	4.6	4.7	4.6	
	Capacity	Rated	kW	2.0	2.5	3.2	3.2	4.0	4.0	5.2	5.2	5.5	5.5
		Min	kW	0.5	0.5	1.0	1.0	1.3	1.3	1.3	1.4	1.4	1.4
	Total Input	Rated	kW	0.500	0.600	0.780	0.780	1.030	1.030	1.390	1.390	1.470	1.470
		Max at 7°C	kW	3.1	3.5	4.1	4.1	4.6	4.6	6.0	6.0	7.3	7.3
Operating Current (Max)	Input	A	5.5	7.0	7.6	7.6	7.6	7.6	9.9	9.9	13.8	13.8	
	Rated	kW	0.017	0.019	0.026	0.026	0.026	0.026	0.032	0.032	0.032	0.032	
Indoor Unit	Operating Current (Max)	A	0.17	0.2	0.3	0.3	0.3	0.3	0.3	0.3	0.3	0.3	
	Dimensions	H*W*D	mm	250-760-199	250-760-199	299-798-245	299-798-245	299-798-245	299-798-245	299-798-245	299-798-245	299-798-245	
	Weight	kg	VGKP 9.1, VGK 8.9	VGKP 9.1, VGK 8.9	VGKP 11, VGK 10.5	VGKP 11, VGK 10.5	VGKP 11, VGK 10.5	VGKP 11, VGK 10.5	VGKP 11, VGK 10.5	VGKP 11, VGK 10.5	VGKP 11, VGK 10.5	VGKP 11, VGK 10.5	
	Air Volume (SLo-Lo-Mid-Hi-SH <sup>(3)</sup> )	Cooling	m <sup>3</sup> /min	28-37-44-52-61	28-37-44-52-66	36-50-63-78-105	36-50-63-78-105	36-50-63-78-111	36-50-63-78-111	45-57-70-84-105	45-57-70-84-105	52-64-75-91-117	52-64-75-91-117
		Heating	m <sup>3</sup> /min	28-39-45-54-61	28-39-45-54-71	40-50-66-80-118	40-50-66-80-118	40-50-66-80-118	40-50-66-80-118	44-54-70-86-129	44-54-70-86-129	48-57-73-91-129	48-57-73-91-129
	Sound Level (SPL)	Cooling	dB(A)	19 <sup>(6)</sup> -26-30-35-40	19 <sup>(6)</sup> -26-30-35-42	18-24-30-36-42	18-24-30-36-42	18-24-30-36-42	18-24-30-36-42	21-29-34-38-42	21-29-34-38-42	26-33-36-40-44	26-33-36-40-44
		Heating	dB(A)	19 <sup>(6)</sup> -26-30-35-40	19 <sup>(6)</sup> -26-30-35-42	18-24-34-39-45	18-24-34-39-45	18-24-31-38-45	18-24-31-38-45	21-29-35-40-45	21-29-35-40-45	26-33-38-43-48	26-33-38-43-48
	Sound Level (PWL)	Cooling	dB(A)	54	57	57	57	57	57	57	57	58	58
		Heating	dB(A)	54	57	57	57	57	57	57	57	58	58
	Dimensions	H*W*D	mm	538-699-249	550-800-285	550-800-285	550-800-285	550-800-285	550-800-285	550-800-285	714-800-285	714-800-285	
	Weight	kg	23	27.5	27	27	28.5	28.5	34	34	40.5	40.5	
	Air Volume	Cooling	m <sup>3</sup> /min	26	32.2	32.2	32.2	32.2	32	32	40.5	40.5	
		Heating	m <sup>3</sup> /min	21	29.8	29.8	29.8	29.8	28.1	28.1	37.4	37.4	
Sound Level (SPL)	Cooling	dB(A)	45	47	47	47	49	49	50	50	52	52	
	Heating	dB(A)	45	48	48	48	50	50	51	51	52	52	
Sound Level (PWL)	Cooling	dB(A)	58	59	59	59	61	61	61	61	64	64	
	Heating	dB(A)	58	59	59	59	61	61	61	61	64	64	
Operating Current (Max)	A	5.3	6.8	7.3	7.3	7.3	7.3	9.6	9.6	13.5	13.5		
Breaker Size	A	10	10	10	10	10	10	10	10	16	16		
Ext. Piping	Diameter	Liquid/Gas	mm	6.35 / 9.52	6.35 / 9.52	6.35 / 9.52	6.35 / 9.52	6.35 / 9.52	6.35 / 9.52	6.35 / 9.52	6.35 / 9.52	6.35 / 9.52	
	Chargeless piping length	Out-In	m	7.5	7.5	7.5	7.5	7.5	7.5	7.5	7.5	7.5	
	Max.Length	Out-In	m	20	20	20	20	20	20	20	20	20	
	Max.Height	Out-In	m	12	12	12	12	12	12	12	12	12	
Guaranteed Operating Range (Outdoor)	Cooling	°C	-10 ~ +46	-10 ~ +46	-10 ~ +46	-10 ~ +46	-10 ~ +46	-10 ~ +46	-10 ~ +46	-10 ~ +46	-10 ~ +46		
	Heating	°C	-15 ~ +24	-20 ~ +24	-20 ~ +24	-20 ~ +24	-20 ~ +24	-20 ~ +24	-20 ~ +24	-20 ~ +24	-20 ~ +24		

(1) Refrigerant leakage contributes to climate change. Refrigerant with lower global warming potential (GWP) would contribute less to global warming than a refrigerant with higher GWP, if leaked to the atmosphere. This appliance contains a refrigerant fluid with a GWP equal to 550. This means that if 1 kg of this refrigerant fluid would be leaked to the atmosphere, the impact on global warming would be 550 times higher than 1 kg of CO<sub>2</sub>, over a period of 100 years. Never try to interfere with the refrigerant circuit yourself or disassemble the product yourself and always ask a professional.  
The GWP of R32 is 675 in the IPCC 4th Assessment Report.

(2) Energy consumption based on standard test results. Actual energy consumption will depend on how the appliance is used and where it is located.

(3) SH: Super High

(4) SEER, SCOP and other related description are based on COMMISSION DELEGATED REGULATION (EU) No.626/2011. The temperature conditions for calculating SCOP are based on "Average Season".

(5) Please see page 53-54 for heating (warmer season) specifications.

(6) For single use: only 19dB(A). For multi use (MXZ): 21dB(A).



# MSZ-AP SERIES



## Indoor Unit

**R32 R410A**

※VGK model Wi-Fi Interface built-in.



MSZ-AP60/71VG(K)

## Outdoor Unit

**R32**



MUZ-AP60VG



MUZ-AP71VG2

## Remote Controller



Type		Inverter Heat Pump			
Indoor Unit		MSZ-AP60VG(K)		MSZ-AP71VG(K)	
Outdoor Unit		MUZ-AP60VG		MUZ-AP71VG	
Refrigerant		Single: R32 <sup>(1)</sup> / Multi: R32 <sup>(1)</sup>			
Power Supply		Outdoor Power supply			
Source		230 / Single / 50			
Outdoor (V / Phase / Hz)					
Cooling	Design load	kW	6.1	7.1	
	Annual electricity consumption <sup>(2)</sup>	kWh/a	288	345	
	SEER <sup>(4)</sup>		7.4	7.2	
	Energy efficiency class		A++	A++	
		Rated	kW	6.1	7.1
	Capacity	Min-Max	kW	1.4-7.3	2.0-8.7
Total Input	Rated	kW	1.590	2.010	
Heating (Average Season) <sup>(3)</sup>	Design load	kW	4.6 (-10°C)	6.7 (-10°C)	
	Declared Capacity	at reference design temperature	kW	4.6 (-10°C)	6.7 (-10°C)
		at bivalent temperature	kW	4.6 (-10°C)	6.7 (-10°C)
	Back up heating capacity	at operation limit temperature	kW	3.7 (-15°C)	5.4 (-15°C)
		Annual electricity consumption <sup>(2)</sup>	kWh/a	1398	2126
	SCOP <sup>(4)</sup>		4.6	4.4	
	Energy efficiency class		A++	A+	
		Rated	kW	6.8	8.1
Capacity	Min-Max	kW	2.0-8.6	2.2-10.3	
Total Input	Rated	kW	1.670	2.120	
Operating Current (Max)		A	14.1	16.4	
Indoor Unit	Input	Rated	kW	0.049	
		Operating Current (Max)	A	0.5	
	Dimensions		H*W*D	325-1100-257	325-1100-257
	Weight		kg	16.0	17.0
	Air Volume (SLo-Lo-Mid-Hi-SH <sup>(3)</sup> )	Cooling	m <sup>3</sup> /min	9.4 - 11.0 - 13.2 - 16.0 - 18.9	9.6 - 11.5 - 13.2 - 15.3 - 18.6
		Heating	m <sup>3</sup> /min	10.8 - 13.4 - 15.4 - 17.4 - 20.3	10.2 - 11.5 - 13.2 - 15.3 - 19.2
	Sound Level (SPL) (SLo-Lo-Mid-Hi-SH <sup>(3)</sup> )	Cooling	dB(A)	29 - 37 - 41 - 45 - 48	30 - 37 - 41 - 45 - 49
		Heating	dB(A)	30 - 37 - 41 - 45 - 48	30 - 37 - 41 - 45 - 51
	Sound Level (PWL)	Cooling	dB(A)	65	65
		Heating	dB(A)	65	65
	Dimensions		H*W*D	714-800-285	880-840-330
	Weight		kg	40	53
	Air Volume	Cooling	m <sup>3</sup> /min	52.1	63.7
		Heating	m <sup>3</sup> /min	52.1	57.7
Sound Level (SPL)	Cooling	dB(A)	56	56	
	Heating	dB(A)	57	55	
Sound Level (PWL)	Cooling	dB(A)	69	69	
	Heating	dB(A)	69	69	
Operating Current (Max)		A	13.6	16.0	
Breaker Size		A	16	20	
Ext. Piping	Diameter		Liquid/Gas	6.35 / 12.7	
	Max.Length	m	30	30	
	Max.Height	m	15	15	
Guaranteed Operating Range (Outdoor)	Cooling	°C	-10 ~ +46	-10 ~ +46	
	Heating	°C	-15 ~ +24	-15 ~ +24	

(1) Refrigerant leakage contributes to climate change. Refrigerant with lower global warming potential (GWP) would contribute less to global warming than a refrigerant with higher GWP, if leaked to the atmosphere. This appliance contains a refrigerant fluid with a GWP equal to 550. This means that if 1 kg of this refrigerant fluid would be leaked to the atmosphere, the impact on global warming would be 550 times higher than 1 kg of CO<sub>2</sub> over a period of 100 years. Never try to interfere with the refrigerant circuit yourself or disassemble the product yourself and always ask a professional.

The GWP of R32 is 675 in the IPCC 4th Assessment Report.

(2) Energy consumption based on standard test results. Actual energy consumption will depend on how the appliance is used and where it is located.

(3) SH: Super High

(4) SEER, SCOP and other related description are based on COMMISSION DELEGATED REGULATION (EU) No.626/2011. The temperature conditions for calculating SCOP are based on "Average Season".

(5) Please see page 53-54 for heating (warmer season) specifications.

禪  
KIRIGAMINE ZEN

# MSZ-E SERIES

Developed to complement modern interior room décor, Kirigamine ZEN air conditioners are available in three colours specially chosen to blend in naturally wherever installed.

R32  
Single / Multi  
R410A  
Multi

MSZ-EF18-50VGB



GOOD DESIGN AWARD 2014 reddot award 2015 winner



## Stylish Line-up Matches Any Room Décor

The streamlined wall-mounted indoor units have eloquent silver-bevelled edges, expressing sophistication and quality. Combining impressively low power consumption and quiet yet powerful performance, these units provide a best-match scenario for diverse interior designs while simultaneously ensuring maximum room and energy savings.



## Energy-efficient Operation

DC Inverter SEER A+++ SCOP A++  
\*except for VEH

All models in the series have achieved high energy-savings rating, and are contributing to reduced energy consumption in homes, offices and a range of other settings. Offered in a variety of output capacities and installation patterns, the vast applicability promises an ideal match for any user.

Indoor \ Outdoor	Rank A for single connection MUZ-EF25/35VG(H) MUZ-EF42/50VG	Compatibility MXZ					
		2F33VF	2F42VF	2F53VF	3F54VF	3F68VF	4F72VF
MSZ-EF18VG	-	✓	✓	✓	✓	✓	✓
MSZ-EF22VG	-	✓	✓	✓	✓	✓	✓
MSZ-EF25VG	A+++ / A++(A+++)	✓	✓	✓	✓	✓	✓
MSZ-EF35VG	A+++ / A++(A+++)		✓	✓	✓	✓	✓
MSZ-EF42VG	A++ / A+			✓	✓	✓	✓
MSZ-EF50VG	A++ / A+			✓	✓	✓	✓

\*VEH

## Quiet Comfort All Day Long

Mitsubishi Electric's advanced "Silent Mode" fan speed setting provides super-quiet operation as low as 19dB for EF18/22/25 models for cooling. This unique feature makes the Kirigamine ZEN series ideal for use in any situation.

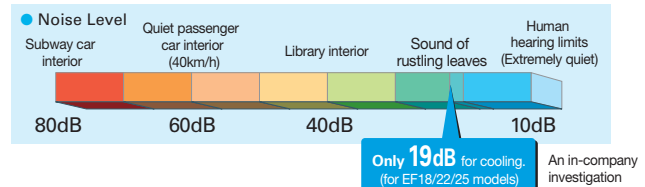

## Superior Exterior and Operating Design Concept

The indoor unit of the Kirigamine ZEN keeps its amazingly thin form even during operation. The only physical change notable is the movement of the variable vent. As a result, a slim attractive look is maintained.

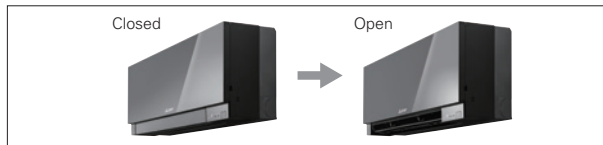

## V Blocking Filter



V Blocking Filter with antiviral effect inhibits 99% of adhered virus, and other harmful substances, such as bacteria, mold and allergen.

Two-layered filter with non-woven fabric and electrostatic filter can effectively capture and remove small particles from the air in your room.

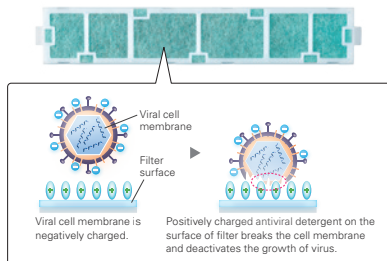

## Low Standby Power

Electrical devices consume standby power even when they are not in actual use. While we obviously strive to reduce power consumption during actual use, reducing this wasted power that cannot be seen is also very important.

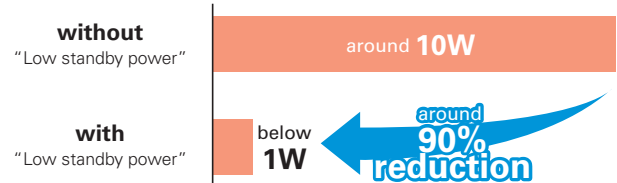

## Outdoor Units for Cold Region

(25/35)

Single split-type outdoor units are available in both standard and heater-equipped units. An electric heater is installed in each unit to prevent freezing in cold outdoor environments.

Standard Units

Heater-equipped Units



MUZ-EF25/35VG



MUZ-EF25/35VGH

# MSZ-E SERIES



## Indoor Unit / Remote Controller

R32 R410A



MSZ-EF18/22/25/35/42/50VG(K)W

White



MSZ-EF18/22/25/35/42/50VG(K)S

Silver



MSZ-EF18/22/25/35/42/50VG(K)B\*

Black

\* Soft-dry Cloth is enclosed with Black models.  
\* VGK model Wi-Fi interface built-in

GOOD DESIGN  
AWARD 2015

reddot award 2015  
winner

## Outdoor Unit

R32



MUZ-EF25/35VG(H),42VG



MUZ-EF50VG



Type	Inverter Heat Pump									
Indoor Unit	MSZ-EF18VG(K)	MSZ-EF22VG(K)	MSZ-EF25VG(K)	MSZ-EF25VG(K)	MSZ-EF35VG(K)	MSZ-EF35VG(K)	MSZ-EF42VG(K)	MSZ-EF50VG(K)	MSZ-EF50VG(K)	
Outdoor Unit	for MXZ connection		MUZ-EF25VG	MUZ-EF25VGH	MUZ-EF35VG	MUZ-EF35VGH	MUZ-EF42VG	MUZ-EF50VG	MUZ-EF50VG	
Refrigerant	R32 <sup>(1)</sup>									
Power Supply	Outdoor Power supply									
Source	230/Single/50									
Outdoor (V / Phase / Hz)										
Cooling	Design load	kW		2.5	2.5	3.5	3.5	4.2	5.0	
	Annual electricity consumption <sup>(2)</sup>	kWh/a		96	96	139	139	186	233	
	SEER <sup>(4)</sup>			9.1	9.1	8.8	8.8	7.9	7.5	
	Energy efficiency class			A+++	A+++	A+++	A+++	A++	A++	
		Capacity	kW		2.5	2.5	3.5	3.5	4.2	5.0
Total Input	Rated	kW		0.9-3.4	0.9-3.4	1.1-4.0	1.1-4.0	0.9-4.6	1.4-5.4	
	Rated	kW		0.540	0.540	0.910	0.910	1.200	1.540	
Heating (Average Season) <sup>(5)</sup>	Design load	kW		2.4 (-10°C)	2.4 (-10°C)	2.9 (-10°C)	2.9 (-10°C)	3.8 (-10°C)	4.2 (-10°C)	
	Declared Capacity	at reference design temperature	kW		2.4 (-10°C)	2.4 (-10°C)	2.9 (-10°C)	2.9 (-10°C)	3.8 (-10°C)	4.2 (-10°C)
		at bivalent temperature	kW		2.4 (-10°C)	2.4 (-10°C)	2.9 (-10°C)	2.9 (-10°C)	3.8 (-10°C)	4.2 (-10°C)
	at operation limit temperature	kW		2.0 (-15°C)	1.6 (-20°C)	2.4 (-15°C)	1.7 (-20°C)	3.4 (-15°C)	3.5 (-15°C)	
	Back up heating capacity	kW		0.0 (-10°C)	0.0 (-10°C)	0.0 (-10°C)	0.0 (-10°C)	0.0 (-10°C)	0.0 (-10°C)	
Annual electricity consumption <sup>(2)</sup>	kWh/a		713	727	882	900	1151	1304		
SCOP <sup>(4)</sup>			4.7	4.6	4.6	4.5	4.6	4.5		
Energy efficiency class			A++	A++	A++	A+	A++	A+		
	Capacity	kW		3.2	3.2	4.0	4.0	5.4	5.8	
Total Input	Rated	kW		1.0-4.2	1.0-4.2	1.3-5.1	1.3-5.1	1.3-6.3	1.4-7.5	
	Rated	kW		0.700	0.700	0.950	0.950	1.455	1.560	
Operating Current (Max)	Input	A		7.1	7.1	7.1	7.1	10.0	14	
	Rated	kW		0.026	0.026	0.026	0.030	0.033	0.043	
Operating Current (Max)	A		0.3	0.3	0.3	0.3	0.3	0.4		
Dimensions	H*W*D	mm		299-885-195	299-885-195	299-885-195	299-885-195	299-885-195	299-885-195	
	Weight	kg		11.5	11.5	11.5	11.5	11.5	11.5	
Air Volume	Cooling	m <sup>3</sup> /min		4.0-4.6-6.3-8.3-10.5	4.0-4.6-6.3-8.3-10.5	4.0-4.6-6.3-8.3-10.5	4.0-4.6-6.3-8.3-10.5	5.8-6.6-7.7-8.9-11.2	5.8-6.6-7.7-8.9-11.2	
	Heating	m <sup>3</sup> /min		4.0-4.6-6.2-8.9-11.9	4.0-4.6-6.2-8.9-11.9	4.0-4.6-6.2-8.9-11.9	4.0-4.6-6.2-8.9-12.7	5.5-6.3-7.8-9.9-13.2	6.4-7.2-9.0-11.1-14.6	
Sound Level (SPL) (SLo-Lo-Mid-Hi-SH) <sup>(3)</sup>	Cooling	dB(A)		19-23-29-36-42	19-23-29-36-42	19-23-29-36-42	21-24-30-36-42	28-31-35-39-43	30-33-36-40-43	
	Heating	dB(A)		21-24-29-37-45	21-24-29-37-45	21-24-29-37-45	21-24-30-38-46	28-30-35-41-48	30-33-37-43-49	
Sound Level (PWL)	Cooling	dB(A)		60	60	60	60	60	60	
	Heating	dB(A)		-	-	550-800-285	550-800-285	550-800-285	714-800-285	
Dimensions	H*W*D	mm		-	-	550-800-285	550-800-285	550-800-285	714-800-285	
	Weight	kg		-	-	31	31	34	35	
Air Volume	Cooling	m <sup>3</sup> /min		-	-	27.8	27.8	34.3	40.2	
	Heating	m <sup>3</sup> /min		-	-	29.8	29.8	32.7	40.2	
Sound Level (SPL)	Cooling	dB(A)		-	-	47	47	49	52	
	Heating	dB(A)		-	-	48	48	50	52	
Sound Level (PWL)	Cooling	dB(A)		-	-	58	58	62	65	
	Heating	dB(A)		-	-	58	58	62	65	
Operating Current (Max)	A	A		6.8	6.8	6.8	6.8	9.6	13.6	
	Breaker Size	A		10	10	10	10	12	16	
Ext. Piping	Diameter	Liquid/Gas		6.35 / 9.52	6.35 / 9.52	6.35 / 9.52	6.35 / 9.52	6.35 / 9.52	6.35 / 9.52	
	Max.Length	m		-	-	20	20	20	30	
	Max.Height	m		-	-	12	12	12	15	
Guaranteed Operating Range (Outdoor)	Cooling	°C		-10 ~ +46	-10 ~ +46	-10 ~ +46	-10 ~ +46	-10 ~ +46	-10 ~ +46	
	Heating	°C		-15 ~ +24	-20 ~ +24	-15 ~ +24	-20 ~ +24	-15 ~ +24	-15 ~ +24	

(1) Refrigerant leakage contributes to climate change. Refrigerant with lower global warming potential (GWP) would contribute less to global warming than a refrigerant with higher GWP, if leaked to the atmosphere. This appliance contains a refrigerant fluid with a GWP equal to 550. This means that if 1 kg of this refrigerant fluid would be leaked to the atmosphere, the impact on global warming would be 550 times higher than 1 kg of CO<sub>2</sub> over a period of 100 years. Never try to interfere with the refrigerant circuit yourself or disassemble the product yourself and always ask a professional.

The GWP of R32 is 675 in the IPCC 4th Assessment Report.

(2) Energy consumption based on standard test results. Actual energy consumption will depend on how the appliance is used and where it is located.

(3) SHi: Super High

(4) SEER, SCOP and other related description are based on COMMISSION DELEGATED REGULATION (EU) No.626/2011. The temperature conditions for calculating SCOP are based on "Average Season".

(5) Please see page 53-54 for heating (warmer season) specifications.

# FT VGHZ R32 SERIES

Single / Multi

Unlike conventional air conditioning systems, the FT Series don't lose heating capacity when it's cold outside. Original technologies ensure excellent heating performance under extremely low outdoor temperatures and an impressive guaranteed operating range. Furthermore, the smaller and stylish indoor unit does not give you the limitation of installation location.

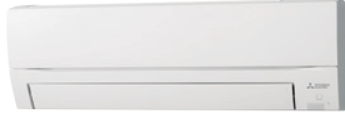

MSZ-FT25/35/50VG(K)

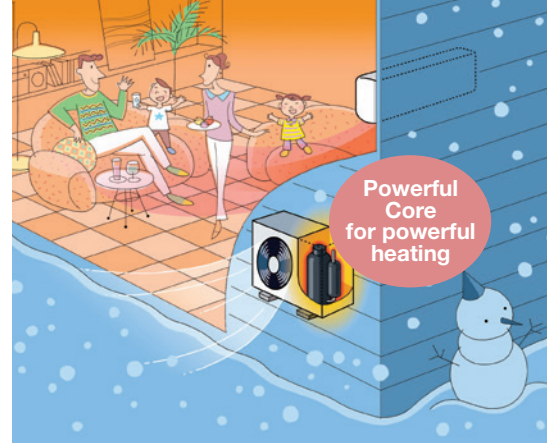

## Compact Design

The FT series features its compact design with 280mm height and 229mm depth, which is suitable for the installation above the door.



## V Blocking Filter (Optional)



V Blocking Filter with antiviral effect inhibits 99% of adhered virus, and other harmful substances, such as bacteria, mold and allergen.

Two-layered filter with non-woven fabric and electrostatic filter can effectively capture and remove small particles from the air in your room.

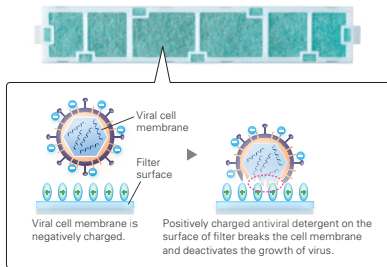

## Remote Controller with Backlight

The remote controller screen is equipped with an LED backlight. The luminous screen allows you to check the setting easily even in the dark.

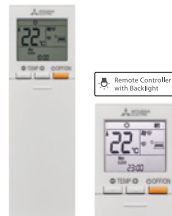

## Circulator Mode

After reaching the target temperature, heating mode will automatically switch to Circulator mode, which makes the unit go into "fan-only" state and mixes warm air in the room.

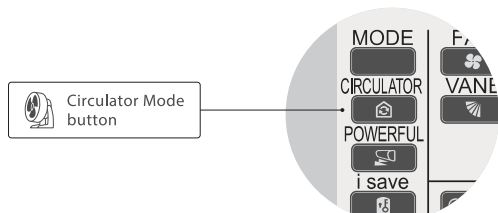

## Built-in Wi-Fi

(MSZ-FT25/35/50VGK)

Mitsubishi Electric Wi-Fi Control gives you the freedom to tailor your heating and cooling needs through computers, tablets, or smartphones from anywhere.

## Hyper Heating

Mitsubishi Electric's powerful compressor and highly cold-resistant parts enable the heat pump to provide 100% or more heating capacity even at  $-15^{\circ}\text{C}$ , and also the heating operation is guaranteed down to  $-25^{\circ}\text{C}$ .

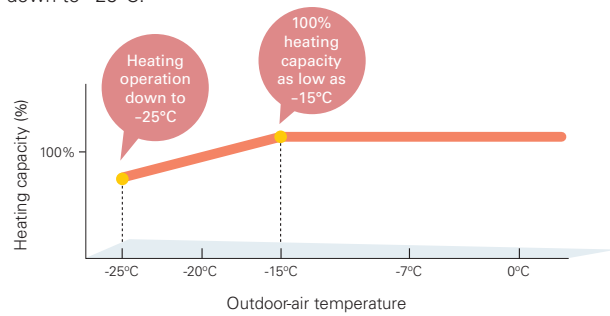

## High Energy Efficiency – Energy Rank of A+ or higher for All Models



With indoor units that combine functionality, design and capacity and outdoor units equipped with a high-efficiency compressor, the MUZ-FT VGHZ simultaneously achieves high heating capacity and energy-saving performance.

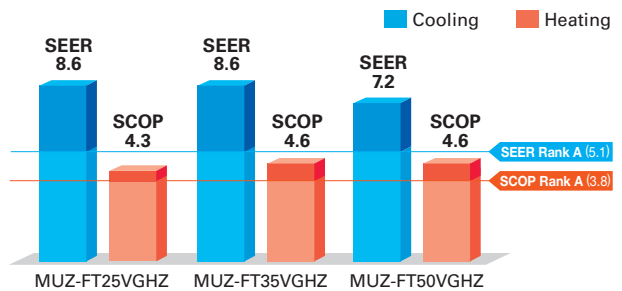

(MSZ-FT25/35/50VG(K)-SC Scandinavian Model)

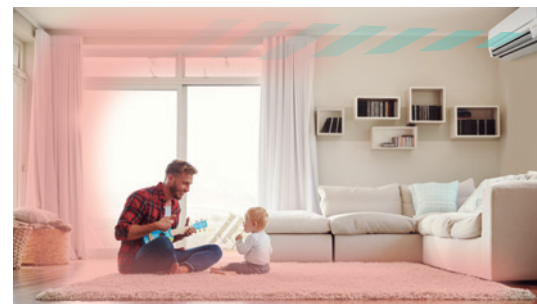

Image is for illustration purposes.

# MSZ-FT VGHZ SERIES



## Indoor Unit



MSZ-FT25/35/50VG(K)

## Outdoor Unit



MUZ-FT25VGHZ

MUZ-FT35/50VGHZ

## Remote Controller



Type		Inverter Heat Pump				
Indoor Unit		MSZ-FT25VG(K)	MSZ-FT35VG(K)	MSZ-FT50VG(K)		
Outdoor Unit		MUZ-FT25VGHZ	MUZ-FT35VGHZ	MUZ-FT50VGHZ		
Refrigerant		R32 <sup>(*)1</sup>				
Power Supply		Outdoor power supply 230 / Single / 50				
Cooling	Design Load	kW	2.5	3.5	5.0	
	Annual Electricity Consumption <sup>(*)2</sup>	kWh/a	101	142	243	
	SEER <sup>(*)4</sup>		8.6	8.6	7.2	
	Capacity	Energy Efficiency Class		A+++	A+++	A++
		Rated	kW	2.5	3.5	5.0
	Total Input	Min - Max	kW	0.8 - 3.5	0.8 - 4.0	0.8 - 5.2
		Rated	kW	0.580	0.910	1.630
Heating (Average Season) <sup>(*)5</sup>	Design Load	kW	3.2 (-10°C)	4.0 (-10°C)	5.0 (-10°C)	
	Declared Capacity	at reference design temperature	kW	3.2 (-10°C)	4.0 (-10°C)	5.0 (-10°C)
		at bivalent temperature	kW	3.2 (-10°C)	4.0 (-10°C)	5.0 (-10°C)
		at operation limit temperature	kW	3.0 (-25°C)	3.4 (-25°C)	3.6 (-25°C)
	Back Up Heating Capacity	kW	0.0 (-10°C)	0.0 (-10°C)	0.0 (-10°C)	
	Annual Electricity Consumption <sup>(*)2</sup>	kWh/a	973	1216	1625	
	SCOP <sup>(*)4</sup>		4.6	4.6	4.3	
	Capacity	Energy Efficiency Class		A++	A++	A+
		Rated	kW	3.2	4.0	5.0
	Total Input	Min - Max	kW	0.9 - 6.2	0.9 - 6.6	0.9 - 7.8
Rated		kW	0.760	1.020	1.300	
Operating Current (max)		A	10.0	11.6	13.9	
Indoor Unit	Input	Rated	kW	0.039	0.04	0.047
	Operating Current (max)		A	0.4		
	Dimensions		H x W x D	mm 280 - 838 - 229		
	Weight		kg	10		
	Air Volume (SLo-Lo-Mid-Hi-SHi <sup>(*)3</sup> )	Cooling	m <sup>3</sup> /min	3.9 - 5.9 - 8.2 - 10.4 - 12.3	3.9 - 6.1 - 8.3 - 10.7 - 13.1	5.5 - 7.6 - 9.8 - 12.0 - 13.1
		Heating	m <sup>3</sup> /min	3.9 - 6.3 - 9.0 - 12.0 - 13.2	3.9 - 6.9 - 10.2 - 13.5 - 14.7	5.5 - 8.4 - 11.4 - 14.4 - 15.5
	Sound Level (SPL) (SLo-Lo-Mid-Hi-SHi <sup>(*)3</sup> )	Cooling	dB(A)	19 - 27 - 36 - 41 - 46	19 - 27 - 36 - 42 - 47	28 - 34 - 40 - 45 - 48
		Heating	dB(A)	19 - 31 - 39 - 46 - 49	19 - 33 - 42 - 49 - 52	28 - 36 - 45 - 51 - 54
	Sound Level (PWL)		dB(A)	60		
	Outdoor Unit	Dimensions		H x W x D	mm 550 - 800 - 285	714 - 800 - 285
Weight		kg	34			
Air Volume		Cooling	m <sup>3</sup> /min	30.4	40.2	40.2
		Heating	m <sup>3</sup> /min	30.4	40.2	40.2
Sound Level (SPL)		Cooling	dB(A)	46	49	51
		Heating	dB(A)	49	52	54
Sound Level (PWL)		dB(A)	60	61	64	
Operating Current (max)		A	9.6	11.2	13.5	
Breaker Size		A	12			
Ext. Piping	Diameter	Liquid / Gas	mm	6.35 / 9.52		
	Max. Length	Out-In	m	20		
	Max. Height	Out-In	m	15		
Guaranteed Operating Range (Outdoor)		Cooling	°C	-10 ~ +46		
		Heating	°C	-25 ~ +24		

(\*)1 Refrigerant leakage contributes to climate change. Refrigerant with lower global warming potential (GWP) would contribute less to global warming than a refrigerant with higher GWP if leaked to the atmosphere. This appliance contains a refrigerant fluid with a GWP equal to 1975. This means that if 1kg of this refrigerant fluid would be leaked to the atmosphere, the impact on global warming would be 1975 times higher than 1kg of CO<sub>2</sub> over a period of 100 years. Never try to interfere with the refrigerant circuit yourself or disassemble the product yourself and always ask a professional. The GWP of R410A is 2088 in the IPCC 4th Assessment Report.

(\*)2 Energy consumption based on standard test results. Actual energy consumption will depend on how the appliance is used and where it is located.

(\*)3 SHi: Super High

(\*)4 SEER, SCOP and other related description are based on COMMISSION DELEGATED REGULATION (EU) No.626/2011. The temperature conditions for calculating SCOP are based on "Average Season".

(\*)5 Please see page 53-54 for heating (warmer season) specifications.

MSZ-BT20/25/35/50VG(K)



# MSZ-BT SERIES

The BT series featured with its high performance, energy efficiency, and simplicity of use brings greater comfort to your room.

## High Energy Efficiency for Entire Range of Series



All models in the series, from the low-capacity 20 to the high-capacity 50, have achieved the "Rank A++" for SEER and size 25 and 35 have achieved the "Rank A++" for SCOP as energy-savings rating. For home use, such as in bedrooms and living rooms, to light commercial use, such as in offices, our air conditioners are contributing to reduced energy consumption in a wide range.

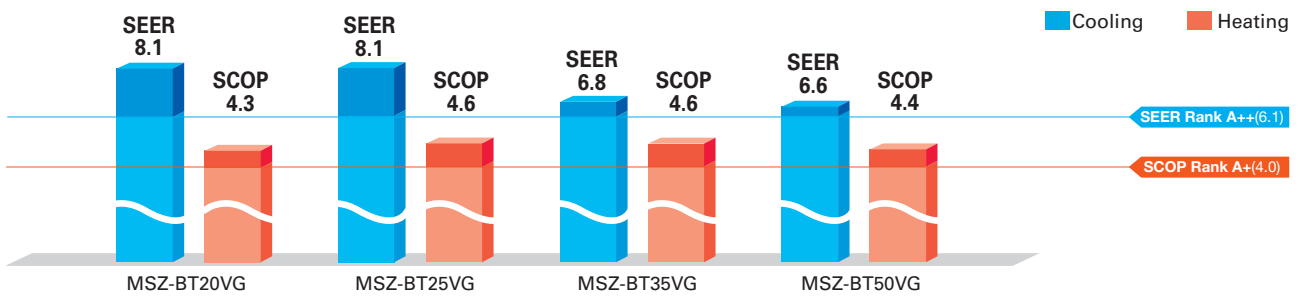

## Quiet Operation

The indoor unit noise level is as low as 19dB for AP Series, offering a peaceful inside environment.

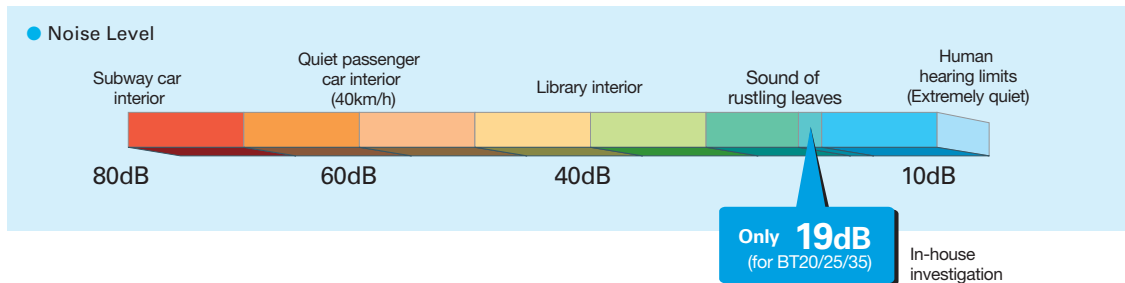

## New Remote Controller

New stylish and compact remote controller features easy-read big display and simple button position with fundamental functions.



## Built-in Wi-Fi Interface (MSZ-BT20/25/35/50VGK)



The indoor unit is equipped with a Wi-Fi Interface inside an exclusive pocket in the unit.

This eliminates the need to install a Wi-Fi interface, and also contributes to the beautiful appearance since the interface is hidden.

## Back Plate with a Hole

With a hole as default in the center of the back plate, the piping can be easily taken out from the back. The edge of the hole is reinforced to ensure the strength.

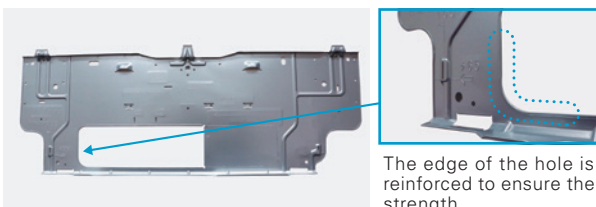

## V Blocking Filter



V Blocking Filter with antiviral effect inhibits 99% of adhered virus, and other harmful substances, such as bacteria, mold and allergen. Two-layered filter with non-woven fabric and electrostatic filter can effectively capture and remove small particles from the air in your room.

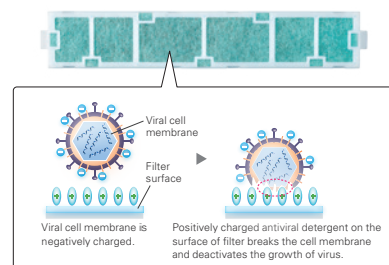

# MSZ-BT SERIES



## Indoor Unit R32



MSZ-BT20/25/35/50VG(K)

## Outdoor Unit



MUZ-BT20VG



MUZ-BT25/35VG



MUZ-BT50VG

## Remote Controller

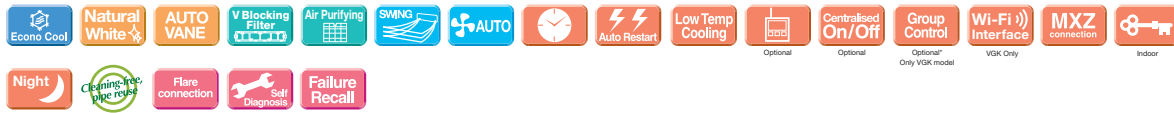

Type	Inverter Heat Pump						
Indoor Unit	MSZ-BT20VG(K)	MSZ-BT25VG(K)	MSZ-BT35VG(K)	MSZ-BT50VG(K)			
Outdoor Unit	MUZ-BT20VG	MUZ-BT25VG	MUZ-BT35VG	MUZ-BT50VG			
Refrigerant	R32 <sup>(1)</sup>						
Power Supply	Outdoor Power supply 230V/Single/50Hz						
Cooling	<b>Design load</b>	kW	2.0	2.5	3.5	5.0	
	<b>Annual electricity consumption<sup>(2)</sup></b>	kWh/a	86	108	180	265	
	<b>SEER<sup>(4)</sup></b>		8.1	8.1	6.8	6.6	
	<b>Capacity</b>	<b>Energy efficiency class</b>		A++	A++	A++	A++
		Rated	kW	2.0	2.5	3.5	5.0
Heating (Average Season) <sup>(5)</sup>	<b>Design load</b>	kW	1.5 (-10°C)	1.9 (-10°C)	2.4 (-10°C)	3.8 (-10°C)	
	<b>Declared Capacity</b>	at reference design temperature	kW	1.5 (-10°C)	1.9 (-10°C)	2.4 (-10°C)	3.8 (-10°C)
		at bivalent temperature	kW	1.5 (-10°C)	1.9 (-10°C)	2.4 (-10°C)	3.8 (-10°C)
	at operation limit temperature	kW	1.3 (-15°C)	1.7 (-15°C)	2.1 (-15°C)	3.4 (-15°C)	
	<b>Back up heating capacity</b>	kW	0.0 (-10°C)	0.0 (-10°C)	0.0 (-10°C)	0.0 (-10°C)	
Operating Current (Max)	<b>Annual electricity consumption<sup>(2)</sup></b>	kWh/a	487	577	727	1209	
	<b>SCOP<sup>(4)</sup></b>		4.3	4.6	4.6	4.4	
	<b>Capacity</b>	<b>Energy efficiency class</b>		A+	A++	A++	A+
		Rated	kW	2.5	3.15	3.6	5.4
	Min-Max	kW	0.7-3.2	0.7-3.5	0.9-4.1	1.4-6.5	
Rated	kW	0.550	0.750	0.930	1.550		
Indoor Unit	<b>Operating Current (Max)</b>	A	5.6	7.0	7.0	10.0	
	<b>Input</b>	Rated	kW	0.024	0.024	0.031	0.037
		Operating Current(Max)	A	0.25	0.25	0.31	0.35
	<b>Dimensions</b>	H*W*D	mm	280-838-235	280-838-235	280-838-235	280-838-235
	<b>Weight</b>		kg	9	9	9	9
	<b>Air Volume (Lo-Mid-Hi-SH)<sup>(3)</sup></b>	Cooling	m <sup>3</sup> /min	4.2 - 5.2 - 6.8 - 8.7 - 10.9	4.2 - 5.2 - 6.8 - 8.7 - 10.9	4.2 - 5.2 - 6.8 - 8.7 - 13.2	6.3 - 7.6 - 9.0 - 11.0 - 13.2
		Heating	m <sup>3</sup> /min	4.2 - 5.0 - 6.8 - 9.0 - 11.9	4.2 - 5.0 - 6.8 - 9.0 - 11.9	4.2 - 5.0 - 6.8 - 9.0 - 11.9	6.0 - 7.8 - 9.9 - 11.9 - 14.1
	<b>Sound Level (SPL) (Lo-Mid-Hi-SH)<sup>(3)</sup></b>	Cooling	dB(A)	19 - 22 - 30 - 37 - 43	19 - 22 - 30 - 37 - 43	19 - 22 - 31 - 38 - 46	29 - 33 - 36 - 40 - 46
		Heating	dB(A)	20 - 23 - 30 - 37 - 43	20 - 23 - 30 - 37 - 43	20 - 23 - 30 - 37 - 44	29 - 33 - 38 - 43 - 48
	<b>Sound Level (PWL)</b>	Cooling	dB(A)	57	57	60	60
Heating		dB(A)	57	57	60	60	
Outdoor Unit	<b>Dimensions</b>	H*W*D	mm	538-699-249	538-699-249	538-699-249	550-800-285
	<b>Weight</b>		kg	23	24	24	35
		Air Volume	Cooling	m <sup>3</sup> /min	30.3	32.2	32.2
	Heating	m <sup>3</sup> /min	30.3	32.2	34.6	32.7	
	<b>Sound Level (SPL)</b>	Cooling	dB(A)	50	50	52	50
		Heating	dB(A)	50	50	52	51
	<b>Sound Level (PWL)</b>	Cooling	dB(A)	63	63	64	64
		Heating	dB(A)	63	63	64	64
	<b>Operating Current (Max)</b>	A	5.3	6.7	6.7	9.6	
	<b>Breaker Size</b>	A	10	10	10	12	
Ext. Piping	<b>Diameter</b>	Liquid/Gas	mm	6.35 / 9.52	6.35 / 9.52	6.35 / 9.52	6.35 / 12.7
	<b>Max.Length</b>	Out-In	m	20	20	20	20
	<b>Max.Height</b>	Out-In	m	12	12	12	12
<b>Guaranteed Operating Range (Outdoor)</b>	Cooling	°C	-10 ~ +46	-10 ~ +46	-10 ~ +46	-10 ~ +46	
	Heating	°C	-15 ~ +24	-15 ~ +24	-15 ~ +24	-15 ~ +24	

(1) Refrigerant leakage contributes to climate change. Refrigerant with lower global warming potential (GWP) would contribute less to global warming than a refrigerant with higher GWP, if leaked to the atmosphere. This appliance contains a refrigerant fluid with a GWP equal to 550. This means that if 1 kg of this refrigerant fluid would be leaked to the atmosphere, the impact on global warming would be 550 times higher than 1 kg of CO<sub>2</sub> over a period of 100 years. Never try to interfere with the refrigerant circuit yourself or disassemble the product yourself and always ask a professional.

The GWP of R32 is 675 in the IPCC 4th Assessment Report.

(2) Energy consumption based on standard test results. Actual energy consumption will depend on how the appliance is used and where it is located.

(3) SHi: Super High

(4) SEER, SCOP and other related description are based on COMMISSION DELEGATED REGULATION (EU) No.626/2011. The temperature conditions for calculating SCOP are based on "Average Season".

(5) Please see page 53-54 for heating (warmer season) specifications.

# MSZ-HR SERIES

Compact, high-performance indoor and outdoor units with R32 that is low global warming potential compared with the current refrigerant R410A contribute to room comfort and to prevent global warming.

R32

MSZ-HR25/35/42/50VF(K)



MSZ-HR60/71VF(K)

## “Rank A++/A+” Energy Savings Achieved for Entire Range of Series



All models in the series, from capacity 25 to 71, have achieved the “Rank A++” for SEER and “Rank A+” for SCOP as energy-savings rating, thanks to Mitsubishi Electric’s inverter technologies which are adopted to provide automatic adjustment of operation load according to need.

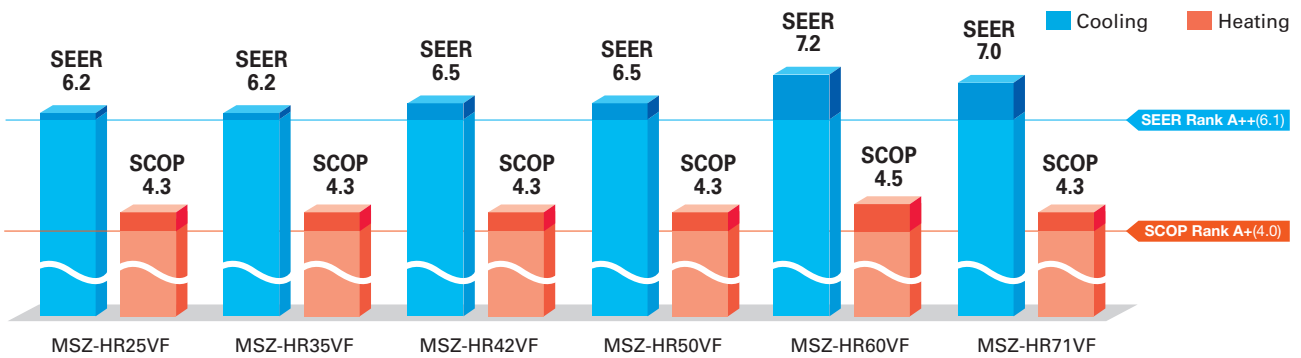

## Simple and Friendly Design

The round front surface provides a simple and friendly impression. And the width of indoor unit is compact, making installation in smaller, tighter spaces possible.

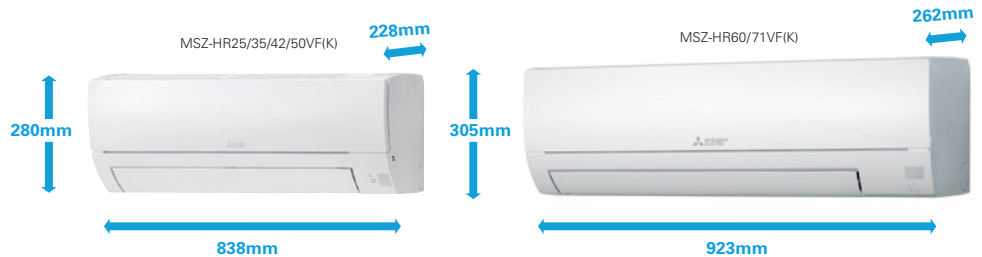

## Wi-Fi® and System Control

### Wi-Fi Interface (Built-in) \*Only VFK model

Built-in interface enabling users to control air conditioners and check operating status via devices such as personal computers, tablets and smartphones.

### System Control Interface (Optional)

- Remote on/off operation is possible by input to the connector.
- Depending on the interface used, connecting a wired remote-control such as the PAR-41MAA is possible.
- Centralised control is possible when connected to M-NET.

\*Wi-Fi Interface and System Control Interface cannot be used simultaneously.

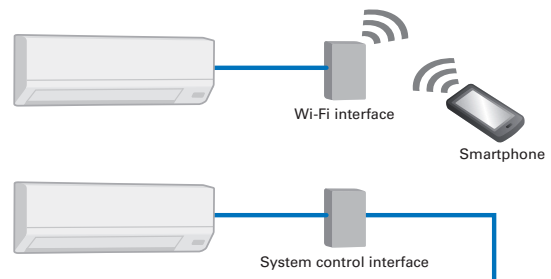

## Back Plate with a Hole

With a hole as default in the center of the back plate, the piping can be easily taken out from the back. The edge of the hole is reinforced to ensure the strength.



## Air Purifying Filter



This filter generates stable antibacterial and deodorising effects. The size of the three-dimensional surface has been increased as well, enlarging the filter capture area. These features give the Air Purifying Filter better dust collection performance than conventional filters. The superior air-cleaning effectiveness raises room comfort yet another level.

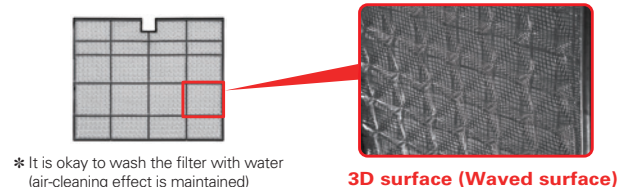



# MSZ-HR SERIES



## Indoor Unit R32



MSZ-HR25/35/42/50VF(K)



MSZ-HR60/71VF(K)

## Outdoor Unit



MUZ-HR25VF



MUZ-HR35VF



MUZ-HR42/50VF



MUZ-HR60/71VF

## Remote Controller

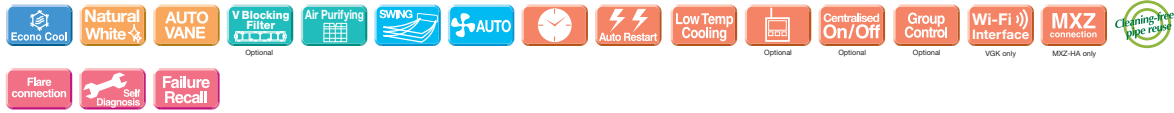

Type	Inverter Heat Pump								
Indoor Unit	MSZ-HR25VF(K)	MSZ-HR35VF(K)	MSZ-HR42VF(K)	MSZ-HR50VF(K)	MSZ-HR60VF(K)	MSZ-HR71VF(K)			
Outdoor Unit	MUZ-HR25VF	MUZ-HR35VF	MUZ-HR42VF	MUZ-HR50VF	MUZ-HR60VF	MUZ-HR71VF			
Refrigerant	R32 <sup>(1)</sup>								
Power Supply	Outdoor Power supply 230V/Single/50Hz								
Cooling	Design load	kW	2.5	3.4	4.2	5.0	6.1	7.1	
	Annual electricity consumption <sup>(2)</sup>	kWh/a	141	191	226	269	296	355	
	SEER <sup>(4)</sup>		6.2	6.2	6.5	6.5	7.2	7.0	
	Capacity	Rated	kW	2.5	3.4	4.2	5.0	6.1	7.1
		Min-Max	kW	0.5-2.9	0.9-3.4	1.1-4.6	1.3-5.0	1.7-7.1	1.8-7.3
Total Input	Rated	kW	0.800	1.210	1.340	2.050	1.810	2.330	
Heating (Average Season) <sup>(3)</sup>	Design load	kW	1.9 (-10°C)	2.4 (-10°C)	2.9 (-10°C)	3.8 (-10°C)	4.6 (-10°C)	5.4 (-10°C)	
	Declared Capacity	at reference design temperature	kW	1.9 (-10°C)	2.4 (-10°C)	2.9 (-10°C)	3.8 (-10°C)	4.6 (-10°C)	5.4 (-10°C)
		at bivalent temperature	kW	1.9 (-10°C)	2.4 (-10°C)	2.9 (-10°C)	3.8 (-10°C)	4.6 (-10°C)	5.4 (-10°C)
		at operation limit temperature	kW	1.9 (-10°C)	2.4 (-10°C)	2.9 (-10°C)	3.8 (-10°C)	4.6 (-10°C)	5.4 (-10°C)
	Back up heating capacity	kW	0.0 (-10°C)	0.0 (-10°C)	0.0 (-10°C)	0.0 (-10°C)	0.0 (-10°C)	0.0 (-10°C)	
	Annual electricity consumption <sup>(2)</sup>	kWh/a	614	781	928	1224	1430	1755	
	SCOP <sup>(4)</sup>		4.3	4.3	4.3	4.3	4.5	4.3	
Capacity	Rated	kW	3.15	3.6	4.7	5.4	6.8	8.1	
	Min-Max	kW	0.7-3.5	0.9-3.7	0.9-5.4	1.4-6.5	1.5-8.5	1.5-9.0	
	Total Input	Rated	kW	0.850	0.975	1.300	1.550	1.810	2.440
	Operating Current (Max)		A	5.0	6.7	8.5	10.0	14.1	14.1
Indoor Unit	Input	Rated	kW	0.020	0.028	0.032	0.039	0.055	0.055
		Operating Current(Max)	A	0.2	0.27	0.3	0.36	0.5	0.5
	Dimensions	H*W*D	mm	280-838-228	280-838-228	280-838-228	280-838-228	305-923-262	305-923-262
	Weight	kg	8.5	8.5	9	9	12.5	12.5	
	Air Volume (Lo-Mid-Hi-SH) <sup>(5)</sup>	Cooling	m <sup>3</sup> /min	3.6 - 5.4 - 7.2 - 9.7	3.6 - 5.6 - 7.8 - 11.7	6.0 - 8.7 - 10.8 - 13.1	6.4 - 9.2 - 11.2 - 13.1	10.4 - 12.6 - 15.4 - 19.6	10.4 - 12.6 - 15.4 - 19.6
		Heating	m <sup>3</sup> /min	3.3 - 5.4 - 7.4 - 10.1	3.3 - 5.4 - 7.4 - 10.5	5.6 - 7.9 - 10.8 - 13.4	6.1 - 8.3 - 11.2 - 14.5	10.7 - 13.1 - 16.7 - 19.6	10.7 - 13.1 - 16.7 - 19.6
	Sound Level (SPL) (Lo-Mid-Hi-SH) <sup>(5)</sup>	Cooling	dB(A)	21 - 30 - 37 - 43	22 - 31 - 38 - 46	24 - 34 - 39 - 45	28 - 36 - 40 - 45	33 - 38 - 44 - 50	33 - 38 - 44 - 50
		Heating	dB(A)	21 - 30 - 37 - 43	21 - 30 - 37 - 44	24 - 32 - 40 - 46	27 - 34 - 41 - 47	33 - 38 - 44 - 50	33 - 38 - 44 - 50
	Sound Level (PWL)	Cooling	dB(A)	57	60	60	60	65	65
	Dimensions	H*W*D	mm	538-699-249	538-699-249	560-800-285	550-800-285	714-800-285	714-800-285
Outdoor Unit	Weight	kg	23	22	32.5	34	40	40	
		Air Volume	Cooling	m <sup>3</sup> /min	30.3	32.2	30.4	30.4	42.8
	Sound Level (SPL)	Cooling	dB(A)	50	51	50	50	53	53
		Heating	dB(A)	50	51	51	51	57	57
	Sound Level (PWL)	Cooling	dB(A)	63	64	64	64	65	66
		Operating Current (Max)	A	4.8	6.4	8.2	9.6	13.6	13.6
	Breaker Size	A	10	10	10	12	16	16	
Ext. Piping	Diameter	Liquid/Gas	mm	6.35 / 9.52	6.35 / 9.52	6.35 / 9.52	6.35 / 9.52	6.35 / 12.7	6.35 / 12.7
	Max.Length	Out-In	m	20	20	20	20	30	30
	Max.Height	Out-In	m	12	12	12	12	15	15
Guaranteed Operating Range (Outdoor)	Cooling	°C	-10 ~ +46	-10 ~ +46	-10 ~ +46	-10 ~ +46	-10 ~ +46	-10 ~ +46	
	Heating	°C	-10 ~ +24	-10 ~ +24	-10 ~ +24	-10 ~ +24	-10 ~ +24	-10 ~ +24	

(1) Refrigerant leakage contributes to climate change. Refrigerant with lower global warming potential (GWP) would contribute less to global warming than a refrigerant with higher GWP, if leaked to the atmosphere. This appliance contains a refrigerant fluid with a GWP equal to 550. This means that if 1 kg of this refrigerant fluid would be leaked to the atmosphere, the impact on global warming would be 550 times higher than 1 kg of CO<sub>2</sub> over a period of 100 years. Never try to interfere with the refrigerant circuit yourself or disassemble the product yourself and always ask a professional.

The GWP of R32 is 675 in the IPCC 4th Assessment Report.

(2) Energy consumption based on standard test results. Actual energy consumption will depend on how the appliance is used and where it is located.

(3) SHi: Super High

(4) SEER, SCOP and other related description are based on COMMISSION DELEGATED REGULATION (EU) No.626/2011. The temperature conditions for calculating SCOP are based on "Average Season".

(5) Please see page 53-54 for heating (warmer season) specifications.

# MSZ-DW SERIES

R32

Introducing an indoor unit that is compact yet packed with a variety of features. High energy saving performance and Air Purifying Filter bring you a comfortable indoor environment.

MSZ-DW25/35/50VF



## Energy Saving



Mitsubishi Electric's inverter technologies are adopted to provide automatic adjustment of operation load according to need. This reduces excessive consumption of electricity, and thereby realises Energy Rank "A++" for SEER (cooling) and "A+" for SCOP (heating).

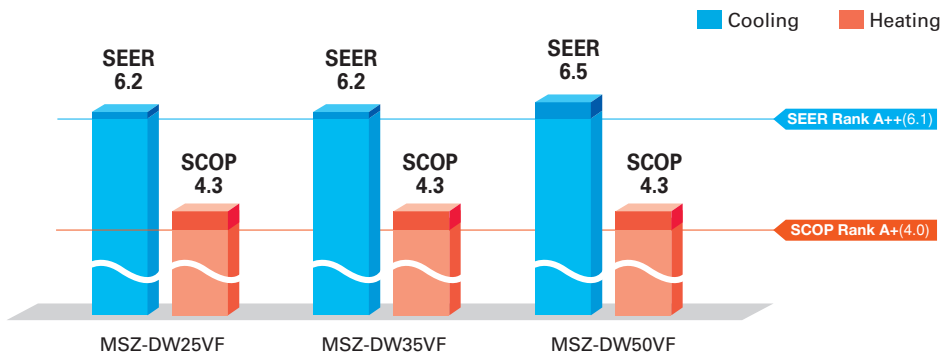

## Simple and Compact Design

The stylish design makes it a natural match for any room. The width of indoor units is compact, making installation in smaller, tighter spaces possible.



## Simple Control

The simple remote controller and functions provide the easy control solution and comforts of life.



## Air Purifying Filter



Air Purifying Filter generates stable antibacterial, antifungal, and deodorant effects. The three-dimensional surface expands the filter's capture area and contributes to the better dust collection performance than conventional filters.

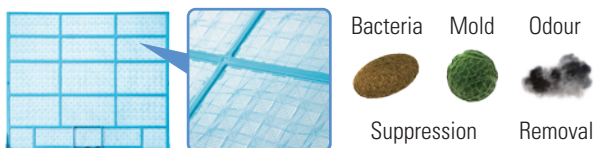

## Wi-Fi and System Control

### Wi-Fi Interface (Optional)

Optional interface and a Cloud-based solution "MELCloud" enable users to control air conditioners and check operating status via devices such as laptops, tablets and smartphones.

### System Control Interface (Optional)

- Remote on/off operation is possible by input to the connector.
- Depending on the interface used, connecting a wired remote control such as the PAR-41MAA is possible.
- Centralised control is possible when connected to M-NET.

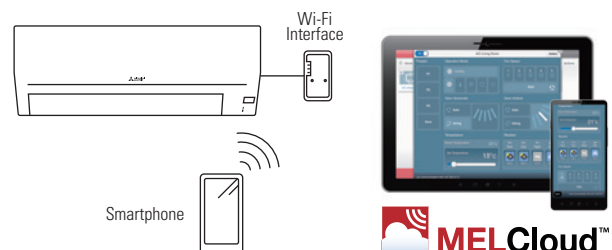

# MSZ-DW SERIES



## Indoor Unit R32



MSZ-DW25/35/50VF

## Outdoor Unit



MUZ-DW25VF



MUZ-DW35VF



MUZ-DW50VF

## Remote Controller

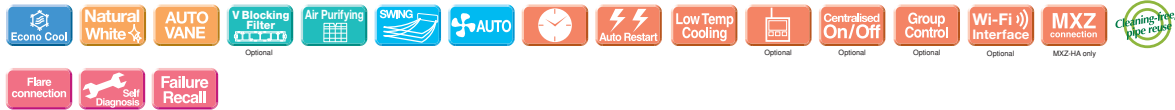

Type	Inverter Heat Pump					
Indoor Unit	MSZ-DW25VF	MSZ-DW35VF	MSZ-DW50VF			
Outdoor Unit	MUZ-DW25VF	MUZ-DW35VF	MUZ-DW50VF			
Refrigerant	R32 <sup>(1)</sup>					
Power Source	Outdoor Power supply					
Supply	Outdoor ( V / Phase / Hz ) 230V/Single/50Hz					
Cooling	Design load	kW	2.5	3.4	5.0	
	Annual electricity consumption <sup>(2)</sup>	kWh/a	135	184	261	
	SEER <sup>(4)</sup>		6.2	6.2	6.5	
	Capacity	Energy efficiency class		A++	A++	A++
		Rated	kW	2.5	3.4	5.0
Total Input	Rated	kW	0.5-2.9	0.9-3.4	1.3-5.0	
	Rated	kW	0.800	1.210	2.050	
Heating (Average Season) <sup>(3)</sup>	Design load	kW	1.9 (-10°C)	2.4 (-10°C)	3.8 (-10°C)	
	Declared Capacity	at reference design temperature	kW	1.9 (-10°C)	2.4 (-10°C)	3.8 (-10°C)
		at bivalent temperature	kW	1.9 (-10°C)	2.4 (-10°C)	3.8 (-10°C)
		at operation limit temperature	kW	1.9 (-10°C)	2.4 (-10°C)	3.8 (-10°C)
	Back up heating capacity	kW	0.0 (-10°C)	0.0 (-10°C)	0.0 (-10°C)	
	Annual electricity consumption <sup>(2)</sup>	kWh/a	618	781	1174	
	SCOP <sup>(4)</sup>		4.3	4.3	4.3	
	Capacity	Energy efficiency class		A+	A+	A+
		Rated	kW	3.15	3.6	5.4
	Total Input	Rated	kW	0.7-3.5	0.9-3.7	1.4-6.5
Rated		kW	0.850	0.975	1.550	
Operating Current (Max)	Rated	A	5.0	6.7	10.0	
	Input	kW	0.023	0.028	0.029	
Indoor Unit	Operating Current(Max)	A	0.24	0.28	0.29	
	Dimensions	H*W*D	mm	290-799-232	290-799-232	
	Weight	kg	9	9	10	
	Air Volume (Lo-Mid-Hi-SH) <sup>(5)</sup>	Cooling	m <sup>3</sup> /min	3.6 - 5.6 - 7.5 - 9.9	3.6 - 5.8 - 8.1 - 11.3	5.9 - 7.7 - 9.7 - 12.3
		Heating	m <sup>3</sup> /min	3.4 - 5.6 - 7.7 - 10.3	3.4 - 5.6 - 7.7 - 10.7	6.0 - 7.7 - 9.7 - 12.6
	Sound Level (SPL) (Lo-Mid-Hi-SH) <sup>(5)</sup>	Cooling	dB(A)	21 - 30 - 37 - 43	22 - 31 - 38 - 46	28 - 36 - 40 - 45
		Heating	dB(A)	21 - 30 - 37 - 43	21 - 30 - 37 - 44	27 - 34 - 41 - 47
	Sound Level (PWL)	Cooling	dB(A)	57	60	60
	Dimensions	H*W*D	mm	538-699-249	538-699-249	550-800-285
	Outdoor Unit	Weight	kg	23	24	35
Air Volume		Cooling	m <sup>3</sup> /min	30.3	32.2	33.5
		Heating	m <sup>3</sup> /min	30.3	32.2	32.7
Sound Level (SPL)		Cooling	dB(A)	50	51	50
		Heating	dB(A)	50	51	51
Sound Level (PWL)		Cooling	dB(A)	63	64	64
		Heating	dB(A)	63	64	64
Operating Current (Max)		A	5.3	7.0	9.2	
Breaker Size		A	10	10	12	
Ext. Piping		Diameter	Liquid/Gas	mm	6.35 / 9.52	6.35 / 9.52
	Max.Length	Out-In	m	20	20	
	Max.Height	Out-In	m	12	12	
Guaranteed Operating Range (Outdoor)	Cooling	°C	-10 ~ +46	-10 ~ +46	-10 ~ +46	
	Heating	°C	-10 ~ +24	-10 ~ +24	-10 ~ +24	

(1) Refrigerant leakage contributes to climate change. Refrigerant with lower global warming potential (GWP) would contribute less to global warming than a refrigerant with higher GWP. If leaked to the atmosphere, this appliance contains a refrigerant fluid with a GWP equal to 550. This means that if 1 kg of this refrigerant fluid would be leaked to the atmosphere, the impact on global warming would be 550 times higher than 1 kg of CO<sub>2</sub> over a period of 100 years. Never try to interfere with the refrigerant circuit yourself or disassemble the product yourself and always ask a professional.

The GWP of R32 is 675 in the IPCC 4th Assessment Report.

(2) Energy consumption based on standard test results. Actual energy consumption will depend on how the appliance is used and where it is located.

(3) SH: Super High

(4) SEER, SCOP and other related description are based on COMMISSION DELEGATED REGULATION (EU) No.626/2011. The temperature conditions for calculating SCOP are based on "Average Season".

(5) Please see page 53-54 for heating (warmer season) specifications.

# MSY-TP SERIES

R32

MSY-TP35/50VF



Cooling only model with high-performance provides high SHF in various environments thanks to wide operation range.

## High Energy-Saving Performance with High SHF

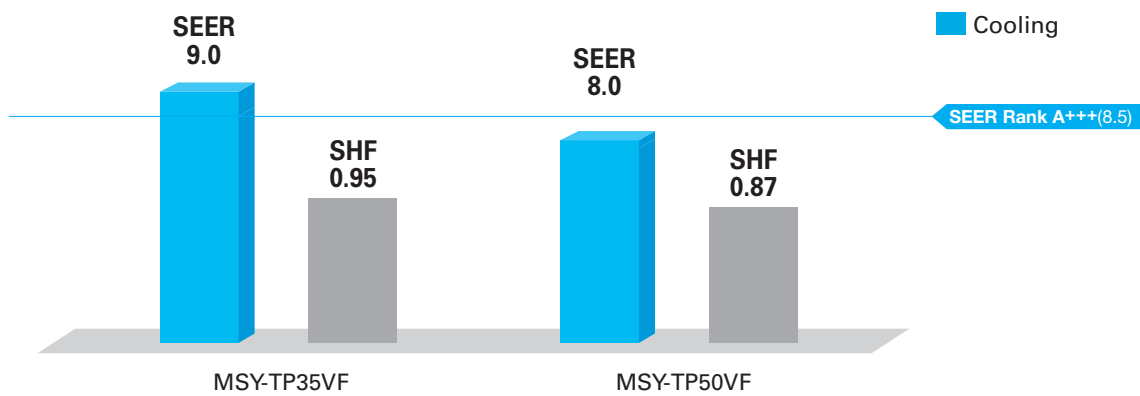

## Wide Cooling Operating Range

As a result of an extended operating range in cooling, these models accommodate a wide range of usage environments and applications.

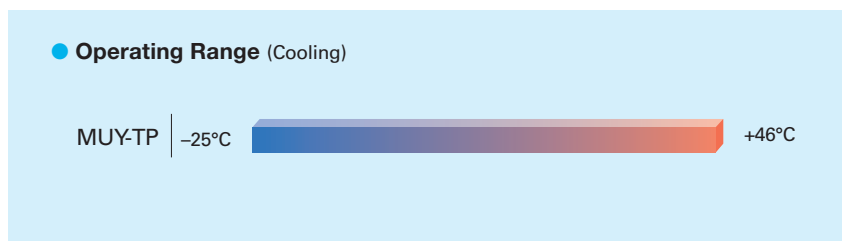

# MSY-TP SERIES



## Indoor Unit R32



MSY-TP35/50VF

## Outdoor Unit R32



MUY-TP35/TP50VF

## Remote Controller

- Wired remote controller can be connected to indoor unit.

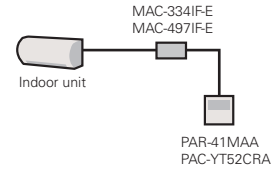

Type		Inverter Heat Pump				
Indoor Unit		MSY-TP35VF		MSY-TP50VF		
Outdoor Unit		MUY-TP35VF		MUY-TP50VF		
Refrigerant		R32 <sup>(1)</sup>				
Power Supply		Indoor Power supply				
Source		230V / Single / 50Hz				
Outdoor (V / Phase / Hz)						
Cooling	Design load	kW	3.5	5.0		
	Annual electricity consumption <sup>(2)</sup>	kWh/a	136	218		
	SEER <sup>(4)</sup>		9.0	8.0		
	Capacity	Energy efficiency class		A+++	A++	
		Rated	kW	3.5	5.0	
	Total Input	Min-Max	kW	1.5 - 4.0	1.5 - 5.7	
Rated		kW	0.760	1.450		
Heating (Average Season) <sup>(3)</sup>	Design load	kW	-	-		
	Declared Capacity	at reference design temperature	kW	-	-	
		at bivalent temperature	kW	-	-	
		at operation limit temperature	kW	-	-	
	Back up heating capacity	kW	-	-		
	Annual electricity consumption <sup>(2)</sup>	kWh/a	-	-		
	SCOP <sup>(4)</sup>		-	-		
	Capacity	Energy efficiency class		-	-	
Rated		kW	-	-		
Total Input	Min-Max	kW	-	-		
	Rated	kW	-	-		
Operating Current (Max)		A	9.6	9.6		
Indoor Unit	Input	Rated	kW	0.033	0.034	
		Operating Current (Max)	A	0.4	0.4	
	Dimensions		H*W*D	mm	305-923-250	305-923-250
	Weight		kg	12.5	12.5	
	Air Volume (Lo-Mid-Hi-SH) <sup>(3)</sup>	Cooling	m <sup>3</sup> /min	10.1 - 11.6 - 13.7 - 16.4	10.1 - 11.6 - 13.7 - 16.4	
		Heating	m <sup>3</sup> /min	-	-	
	Sound Level (SPL) (Lo-Mid-Hi-SH) <sup>(3)</sup>	Cooling	dB(A)	31 - 36 - 40 - 45	31 - 36 - 40 - 45	
		Heating	dB(A)	-	-	
	Sound Level (PWL)	Cooling	dB(A)	60	60	
		Heating	dB(A)	10	10	
	Breaker Size		A	10	10	
	Outdoor Unit	Dimensions		H*W*D	mm	550-800-285
Weight		kg	34	34		
Air Volume		Cooling	m <sup>3</sup> /min	29.3	29.3	
		Heating	m <sup>3</sup> /min	-	-	
Sound Level (SPL)		Cooling	dB(A)	45	47	
		Heating	dB(A)	-	-	
Sound Level (PWL)		Cooling	dB(A)	58	61	
		Heating	dB(A)	9.2	9.2	
Operating Current (Max)		A	9.2	9.2		
Ext. Piping	Diameter	Liquid/Gas	mm	6.35/9.52	6.35/9.52	
	Max.Length	Out-In	m	20	20	
	Max.Height	Out-In	m	12	12	
Guaranteed Operating Range (Outdoor)		Cooling	°C	-25 ~ +46	-25 ~ +46	
		Heating	°C	-	-	

<sup>(1)</sup> Refrigerant leakage contributes to climate change. Refrigerant with lower global warming potential (GWP) would contribute less to global warming than a refrigerant with higher GWP, if leaked to the atmosphere. This appliance contains a refrigerant fluid with a GWP equal to 550. This means that if 1 kg of this refrigerant fluid would be leaked to the atmosphere, the impact on global warming would be 550 times higher than 1 kg of CO<sub>2</sub> over a period of 100 years. Never try to interfere with the refrigerant circuit yourself or disassemble the product yourself and always ask a professional.  
The GWP of R32 is 675 in the IPCC 4th Assessment Report.

<sup>(2)</sup> Energy consumption based on standard test results. Actual energy consumption will depend on how the appliance is used and where it is located.

<sup>(3)</sup> SHi: Super High

<sup>(4)</sup> SEER and other related description are based on COMMISSION DELEGATED REGULATION (EU) No.626/2011.

# MFZ SERIES

High Capacity, Energy Savings and a Design in Harmony with Living Spaces  
Raise the Value of Your Room to the Next Level.

MFZ-KT25/35/50/60VG

R32



## Simple, Flat Design

Uneven surfaces have been smoothed to provide a simple design with linear beauty, harmonised with all types of interiors.

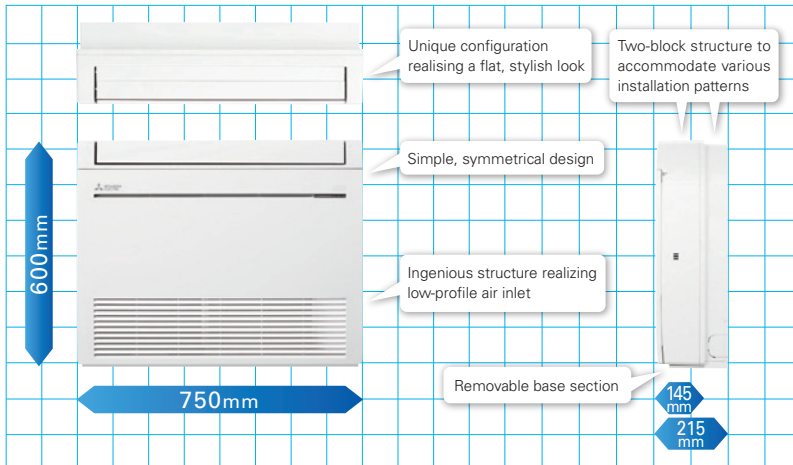

### Images of installed unit

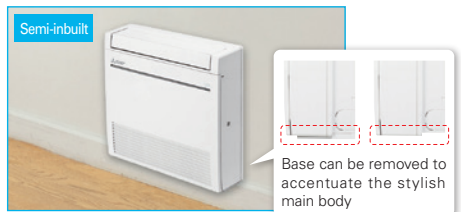

## New Line-up

New models have been introduced to expand the line-up. The diverse selection enables the best solution for both customers and locations.

Capacity	2.5kW	3.5kW	5.0kW	6.0kW
MFZ-KJ	✓	✓	✓	
MFZ-KT	✓	✓	✓	✓

## Multi-flow Vane

Three uniquely shaped vanes control the airflow and allow the freedom to customize comfort according to preferences.

### When heating

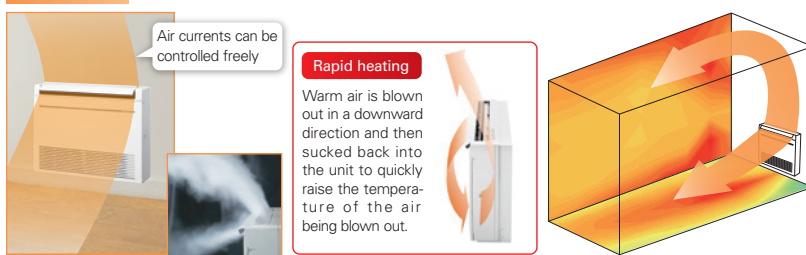

### When cooling

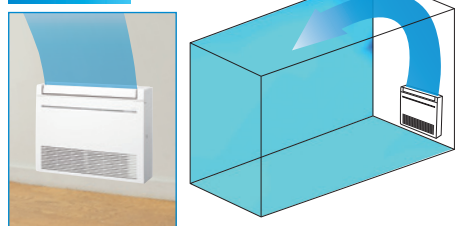

\* The downward airflow is also possible as well as heating.

## Weekly Timer (Introduced in response to market demand)

Temperature settings and On/Off control can be managed over a period of one week using the Weekly Timer. Up to eight setting patterns per calendar day are possible.

## V Blocking Filter



V Blocking Filter with antiviral effect inhibits 99% of adhered virus, and other harmful substances, such as bacteria, mold and allergen. Two-layered filter with non-woven fabric and electrostatic capture and remove small particles from the air in your room.

Viral cell membrane is negatively charged. Positively charged antiviral detergent on the surface of filter breaks the cell membrane and deactivates the growth of virus.

## Quiet Operation

The indoor unit noise level is as low as 19dB for MFZ Series, offering a peaceful inside environment.

\* Single connection only.

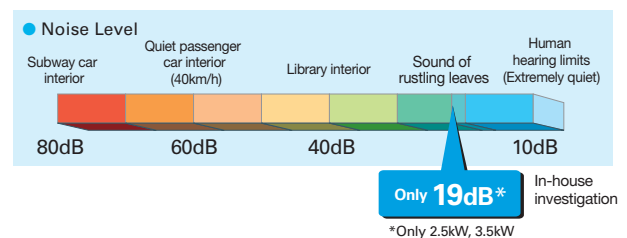

# MFZ-KT SERIES



## Indoor Unit

R32



MFZ-KT25/35/50/60VG

## Outdoor Unit

R32



SUZ-M25/35VA



SUZ-M50VA



SUZ-M60VA

## Remote Controller



Enclosed in MFZ-KT



\*optional



\*optional



\*optional

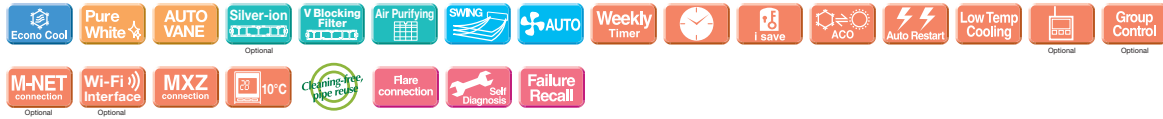

Type		Inverter Heat Pump						
Indoor Unit		MFZ-KT25VG	MFZ-KT35VG	MFZ-KT50VG	MFZ-KT60VG			
Outdoor Unit		SUZ-M25VA	SUZ-M35VA	SUZ-M50VA	SUZ-M60VA			
Refrigerant		R32 <sup>(*)</sup>	R32 <sup>(*)</sup>	R32 <sup>(*)</sup>	R32 <sup>(*)</sup>			
Power Supply		Outdoor power supply 230 / Single / 50						
Cooling	Design load	kW	2.5	3.5	5.0	6.1		
	Annual electricity consumption <sup>(2)</sup>	kWh/a	134	185	257	343		
	SEER <sup>(4), (5)</sup>		6.5	6.6	6.8	6.2		
	Capacity	Energy efficiency class		A <sup>++</sup>	A <sup>++</sup>	A <sup>++</sup>	A <sup>++</sup>	
		Rated	kW	2.5	3.5	5.0	6.1	
Total Input	Min-Max	kW	1.6 - 3.2	0.9 - 3.9	1.2 - 5.6	1.7 - 6.3		
	Rated	kW	0.62	1.06	1.55	1.84		
Heating (Average Season)	Design load	kW	2.2	2.6	4.3	4.6		
	Declared Capacity	at reference design temperature	kW	2.0 (-10°C)	2.3 (-10°C)	3.5 (-10°C)	4.1 (-10°C)	
		at bivalent temperature	kW	2.0 (-7°C)	2.3 (-7°C)	3.9 (-7°C)	4.1 (-7°C)	
		at operation limit temperature	kW	2.0 (-10°C)	2.3 (-10°C)	3.5 (-10°C)	4.1 (-10°C)	
	Back up heating capacity	kW	0.2	0.3	0.8	0.5		
	Annual electricity consumption <sup>(2)</sup>	kWh/a	732	825	1423	1568		
	SCOP <sup>(4), (5)</sup>		4.2	4.4	4.2	4.1		
Capacity	Energy efficiency class		A <sup>+</sup>	A <sup>+</sup>	A <sup>+</sup>	A <sup>+</sup>		
	Rated	kW	3.4	4.3	6.0	7.0		
Total Input	Min-Max	kW	1.3 - 4.2	1.1 - 5.0	1.5 - 7.2	1.6 - 8.0		
	Rated	kW	0.91	1.26	1.86	2.18		
Operating Current (Max)								
Input	Rated	kW	0.020 / 0.024	0.020 / 0.024	0.037 / 0.052	0.063 / 0.059		
	Operating Current(Max)	A	0.20	0.20	0.45	0.55		
Indoor Unit	Dimensions		H*W*D	mm	600-750-215	600-750-215	600-750-215	600-750-215
	Weight			kg	14.5	14.5	14.5	15.0
	Air Volume (SLO-Lo-Mid-Hi-SHI <sup>(3)</sup> )	Cooling	m <sup>3</sup> /min	3.9 - 4.8 - 6.5 - 7.8 - 8.9	3.9 - 4.8 - 6.5 - 7.8 - 8.9	5.6 - 6.7 - 8.6 - 10.4 - 12.3	5.6 - 8.0 - 9.6 - 12.3 - 15.0	6.0 - 7.7 - 9.4 - 11.6 - 14.0
		Heating	m <sup>3</sup> /min	3.5 - 4.0 - 5.6 - 7.3 - 9.7	3.5 - 4.0 - 5.6 - 7.3 - 9.7	6.0 - 7.7 - 9.4 - 11.6 - 14.0	6.0 - 7.7 - 9.7 - 12.5 - 14.6	
	Sound Level (SPL) (SLO-Lo-Mid-Hi-SHI <sup>(3)</sup> )	Cooling	dB(A)	19 - 24 - 31 - 37 - 41	19 - 24 - 31 - 37 - 41	28 - 32 - 37 - 42 - 48	28 - 36 - 40 - 46 - 53	29 - 35 - 41 - 47 - 51
		Heating	dB(A)	19 - 23 - 30 - 37 - 44	19 - 23 - 30 - 37 - 44	29 - 35 - 40 - 44 - 49	29 - 35 - 41 - 47 - 51	
	Sound Level (PWL)	Cooling	dB(A)	54	54	60	65	
Outdoor Unit	Dimensions		H*W*D	mm	550-800-285	550-800-285	714-800-285	880-840-300
	Weight			kg	30	35	41	54
	Air Volume	Cooling	m <sup>3</sup> /min	36.3	34.3	45.8	50.1	
		Heating	m <sup>3</sup> /min	34.6	32.7	43.7	50.1	
	Sound Level (SPL)	Cooling	dB(A)	45	48	48	49	
		Heating	dB(A)	46	48	49	51	
	Sound Level (PWL)	Cooling	dB(A)	59	59	64	65	
Operating Current(Max)		A	7	9	14	15		
Breaker Size		A	10	10	16	16		
Ext. Piping	Diameter	Liquid/Gas	mm	6.35 / 9.52	6.35 / 9.52	6.35 / 12.7	6.35 / 15.88	
	Max.Length	Out-In	m	20	20	30	30	
	Max.Height	Out-In	m	12	12	30	30	
Guaranteed Operating Range [Outdoor]								
		Cooling	°C	-10 ~ +46	-10 ~ +46	-15 ~ +46	-15 ~ +46	
		Heating	°C	-10 ~ +24	-10 ~ +24	-10 ~ +24	-10 ~ +24	

(\*) Refrigerant leakage contributes to climate change. Refrigerant with lower global warming potential (GWP) would contribute less to global warming than a refrigerant with higher GWP, if leaked to the atmosphere. This appliance contains a refrigerant fluid with a GWP equal to 1975. This means that if 1 kg of this refrigerant fluid would be leaked to the atmosphere, the impact on global warming would be 1975 times higher than 1 kg of CO<sub>2</sub>, over a period of 100 years. Never try to interfere with the refrigerant circuit yourself or disassemble the product yourself and always ask a professional.  
The GWP of R410A is 2088 in the IPCC 4th Assessment Report.

(2) Energy consumption based on standard test results. Actual energy consumption will depend on how the appliance is used and where it is located.

(3) SH: Super High

(4) SEER, SCOP and other related description are based on COMMISSION DELEGATED REGULATION (EU) No 626/2011. The temperature conditions for calculating SCOP are based on "Average Season".

(5) SEER and SCOP are based on 2009/125/EC Energy-related Products Directive and Regulation (EU) No 206/2012.

# MFZ-KW SERIES



## Indoor Unit



MFZ-KW25/35/50/60VG



## Outdoor Unit



MUFZ-KW25/35VGHZ



MUFZ-KW50/60VGHZ

## Remote Controller



Type		Inverter Heat Pump					
Indoor Unit		MFZ-KW25VG	MFZ-KW35VG	MFZ-KW50VG	MFZ-KW60VG		
Outdoor Unit		MUFZ-KW25VGHZ	MUFZ-KW35VGHZ	MUFZ-KW50VGHZ	MUFZ-KW60VGHZ		
Refrigerant		R32 <sup>(*)1</sup>					
Power Supply		Outdoor power supply					
Source		230 / Single / 50					
Outdoor (V/Phase/Hz)							
Cooling	Design Load	kW	2.5	3.5	5.0	6.1	
	Annual Electricity Consumption <sup>(*)2</sup>	kWh/a	103	151	255	316	
	SEER <sup>(*)4</sup>		8.5	8.1	6.8	6.7	
	Capacity	Energy Efficiency Class		A+++	A++	A++	A++
		Rated	kW	2.5	3.5	5.0	6.1
	Min - Max	kW	0.7 - 3.6	0.7 - 4.3	1.0 - 5.8	1.0 - 6.5	
	Total Input	Rated	kW	0.57	0.90	1.36	1.73
Heating (Average Season)	Design Load	kW	3.5	3.6	4.5	4.8	
	Declared Capacity	at reference design temperature	kW	3.5 (-10°C)	3.6 (-10°C)	4.5 (-10°C)	4.8 (-10°C)
		at bivalent temperature	kW	3.5 (-10°C)	3.6 (-10°C)	4.5 (-10°C)	4.8 (-10°C)
		at operation limit temperature	kW	2.6 (-25°C)	2.6 (-25°C)	4.0 (-25°C)	4.0 (-25°C)
	Back Up Heating Capacity	kW	0.0 (-10°C)	0.0 (-10°C)	0.0 (-10°C)	0.0 (-10°C)	
	Annual Electricity Consumption <sup>(*)2</sup>	kWh/a	1188	1211	1500	1624	
	SCOP <sup>(*)4</sup>		4.1	4.1	4.2	4.1	
	Capacity	Energy Efficiency Class		A+	A+	A+	A+
		Rated	kW	3.4	4.3	6.0	6.5
	Min - Max	kW	0.2 - 5.1	0.2 - 6.0	1.2 - 8.4	1.2 - 9.0	
Total Input	Rated	kW	0.83	1.21	1.60	1.88	
Operating Current (max)		A	9.9	10.3	15.3	15.4	
Indoor Unit	Input (Cooling/Heating)	Rated	kW	0.019/0.025	0.019/0.025	0.026/0.052	0.063/0.059
	Operating Current (max)	A	0.22	0.22	0.47	0.55	
	Dimensions	H x W x D	mm	600 - 750 - 215			
	Weight	kg	15	15	15	15	
	Air Volume (SLo-Lo-Mid-Hi-SHi <sup>(*)3</sup> )	Cooling	m <sup>3</sup> /min	3.9 - 4.9 - 5.9 - 7.1 - 8.2	3.9 - 4.9 - 5.9 - 7.1 - 8.2	5.6 - 6.7 - 8.0 - 9.3 - 10.6	5.6 - 8.0 - 9.6 - 12.3 - 15.0
		Heating	m <sup>3</sup> /min	3.5 - 5.1 - 6.2 - 7.7 - 9.7	3.5 - 5.1 - 6.2 - 7.7 - 9.7	6.0 - 7.4 - 9.4 - 11.6 - 14.0	6.0 - 7.7 - 9.7 - 12.5 - 14.6
	Sound Level (SPL) (SLo-Lo-Mid-Hi-SHi <sup>(*)3</sup> )	Cooling	dB(A)	20 - 25 - 30 - 35 - 39	20 - 25 - 30 - 35 - 39	27 - 31 - 35 - 39 - 44	27 - 35 - 39 - 46 - 53
		Heating	dB(A)	18 - 25 - 30 - 35 - 41	18 - 25 - 30 - 35 - 41	29 - 35 - 40 - 45 - 50	29 - 35 - 41 - 47 - 51
	Sound Level (PWL)	dB(A)	49	50	56	65	
	Outdoor Unit	Dimensions	H x W x D	mm	550 - 800 - 285	880 - 840 - 330	
Weight		kg	35	35	54	54	
Air Volume		Cooling	m <sup>3</sup> /min	32.7	32.7	43.8	48.8
		Heating	m <sup>3</sup> /min	27.3	27.3	46.3	51.3
Sound Level (SPL)		Cooling	dB(A)	47	47	50	52
		Heating	dB(A)	46	47	54	56
Sound Level (PWL)		Cooling	dB(A)	61	61	65	66
Operating Current (max)		A	9.6	10.0	14.8	14.8	
Breaker Size		A	10	12	16	16	
Ext. Piping		Diameter	Liquid / Gas	mm	6.35 / 9.52	6.35 / 9.52	6.35 / 12.7
	Max. Length	Out-In	m	20	20	30	30
	Max. Height	Out-In	m	12	12	15	15
Guaranteed Operating Range (Outdoor)	Cooling	°C	-10 ~ +46	-10 ~ +46	-10 ~ +46	-10 ~ +46	
	Heating	°C	-25 ~ +24	-25 ~ +24	-25 ~ +24	-25 ~ +24	

(\*)1 Refrigerant leakage contributes to climate change. Refrigerant with lower global warming potential (GWP) would contribute less to global warming than a refrigerant with higher GWP if leaked to the atmosphere. This appliance contains a refrigerant fluid with a GWP equal to 1975. This means that if 1kg of this refrigerant fluid would be leaked to the atmosphere, the impact on global warming would be 1975 times higher than 1kg of CO<sub>2</sub> over a period of 100 years. Never try to interfere with the refrigerant circuit yourself or disassemble the product yourself and always ask a professional. The GWP of R410A is 2088 in the IPCC 4th Assessment Report.

(\*)2 Energy consumption based on standard test results. Actual energy consumption will depend on how the appliance is used and where it is located.

(\*)3 SHi: Super High

(\*)4 SEER, SCOP and other related description are based on COMMISSION DELEGATED REGULATION (EU) No.626/2011. The temperature conditions for calculating SCOP are based on "Average Season".





# MLZ SERIES

Introducing a new type of ceiling cassette for the Multi-Split Series with streamlined interior dimensions and a sharp, sleek appearance.

MLZ-KP25/35/50VF

R32

MLZ-KY20VG

reddot award 2018 winner



## Slim Design KY KP

Industry leading slim body realized a simple design with linear beauty.

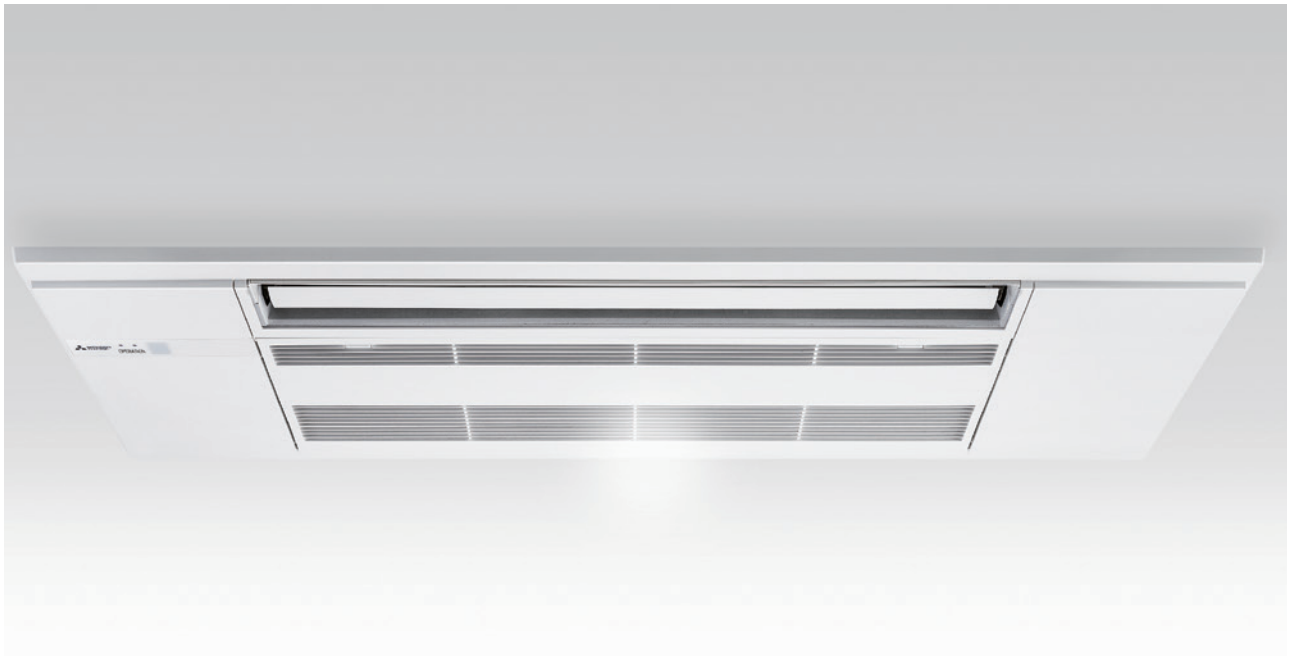

## Ceiling Mounted KY KP

Installing the ceiling-mounted MLZ Series unit in a room creates a more spacious feel that enhances room comfort. This overhead format is also an excellent solution when lighting equipment is installed at the centre of the room and fixtures such as book shelves are mounted on wall surfaces.

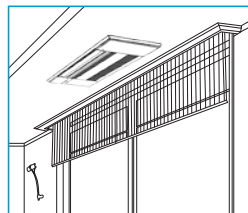

## V Blocking Filter KY

V Blocking Filter with antiviral effect inhibits 99% of adhered virus and other harmful substances, such as bacteria, mold and allergen. Two-layered filter with non-woven fabric and electrostatic filter can effectively capture and remove small particles from the air in your room.

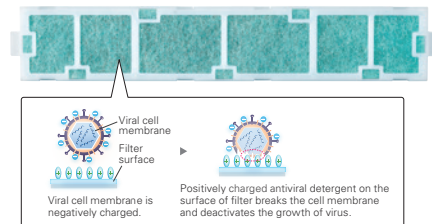

## Set Airflow According to Ceiling Height KY KP

Dual-level airflow selection is engineered to accommodate specific ceiling heights. This is a key feature for adjusting airflow effectively when it is either too strong or too weak due to being mismatched with the height of the ceiling.

	20	25	35	50
Standard	2.4m	2.4m	2.4m	2.4m
High ceiling	2.7m	2.7m	2.7m	2.7m

## Auto Vane Control KY KP

Outlet vanes can be moved left and right, and up and down using the remote controller. This improved airflow control feature solves the problem of drafts.

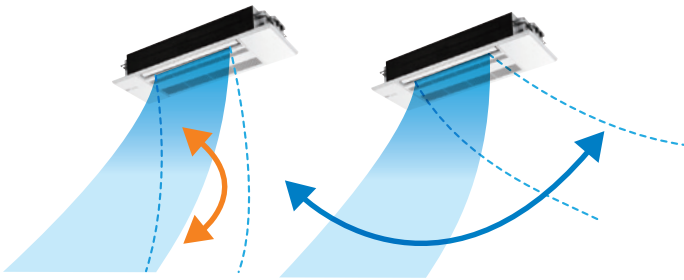

**Up and Down**

**Left and Right**

\*Only available when Econo Cool is set.

## Horizontal Airflow KY KP

The new airflow control completely eliminates that uncomfortable drafty-feeling with the introduction of a horizontal airflow that spreads across the ceiling. The ideal airflow for offices and restaurants.

[Horizontal Airflow]  
Model name: MLZ-KP35VF  
Ceiling height: 2.4m  
Model: Cooling

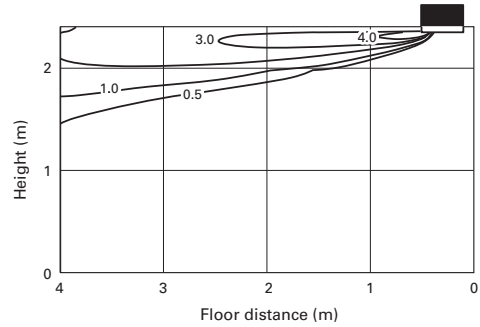

## Weekly Timer KY KP Built-in Weekly Timer Function

Easily set desired temperatures and operation ON/OFF times to match lifestyle patterns. Reduce wasted energy consumption by using the timer to prevent forgetting to turn off the unit and eliminate temperature setting adjustments.

### Example Operation Pattern (Winter/Heating mode)

	Mon.	Tues.	Wed.	Thurs.	Fri.	Sat.	Sun.
6:00	ON 20°C	ON 20°C	ON 20°C	ON 20°C	ON 20°C	ON 20°C	ON 20°C
8:00	Automatically changes to high-power operation at wake-up time						
10:00	OFF	OFF	OFF	OFF	OFF	ON 18°C	ON 18°C
12:00	Automatically turned off during work hours					Midday is warmer, so the temperature is set lower	
14:00							
16:00							
18:00	ON 22°C	ON 22°C	ON 22°C	ON 22°C	ON 22°C	ON 22°C	ON 22°C
20:00	Automatically turns on, synchronized with arrival at home					Automatically raises temperature setting to match time when outside-air temperature is low	
22:00							
(during sleeping hours)	ON 18°C	ON 18°C	ON 18°C	ON 18°C	ON 18°C	ON 10°C	ON 10°C
	Automatically lowers temperature at bedtime for energy-saving operation at night						

### Settings

**Pattern Settings:** Input up to four settings for each day

**Settings:** •Start/Stop operation •Temperature setting \*The operation mode cannot be set.

### Easy set-up using dedicated buttons



The remote controller is equipped with buttons that are used exclusively for setting the Weekly Timer. Setting operation patterns is easy and quick.



- Start by pushing the "SET" button and follow the instructions to set the desired patterns. Once all of the desired patterns are input, point the top end of the remote controller at the indoor unit and push the "SET" button one more time. (Push the "SET" button only after inputting all of the desired patterns into the remote controller memory. Pushing the "CANCEL" button will end the set-up process without sending the operation patterns to the indoor unit).
- It takes a few seconds to transmit the Weekly Timer operation patterns to the indoor unit. Please continue to point the remote controller at the indoor unit until all data has been sent.

# Easy Installation

## Temporary hanging hook KY KP

Work efficiency has improved during installation.

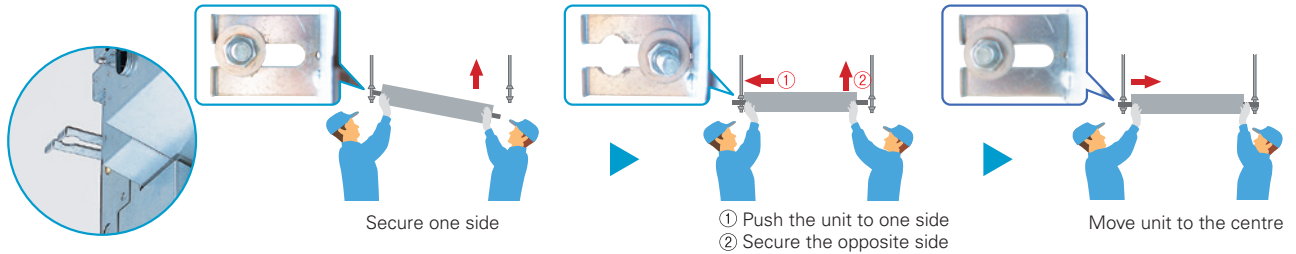

## Refrigerant Piping Supporters + Drain Cover KY KP

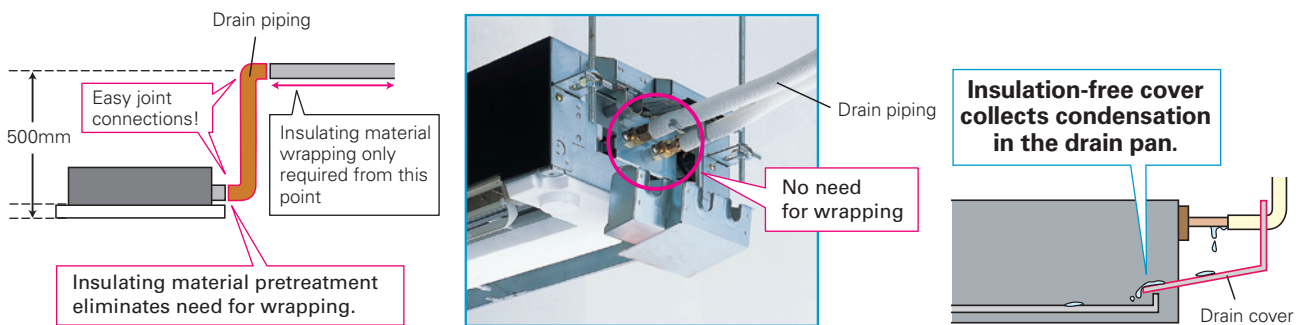

## High Serviceability KY KP

No need to put off the panel even when the unit has some troubles to be checked inside. Simply open the panel to see the inside of the unit.

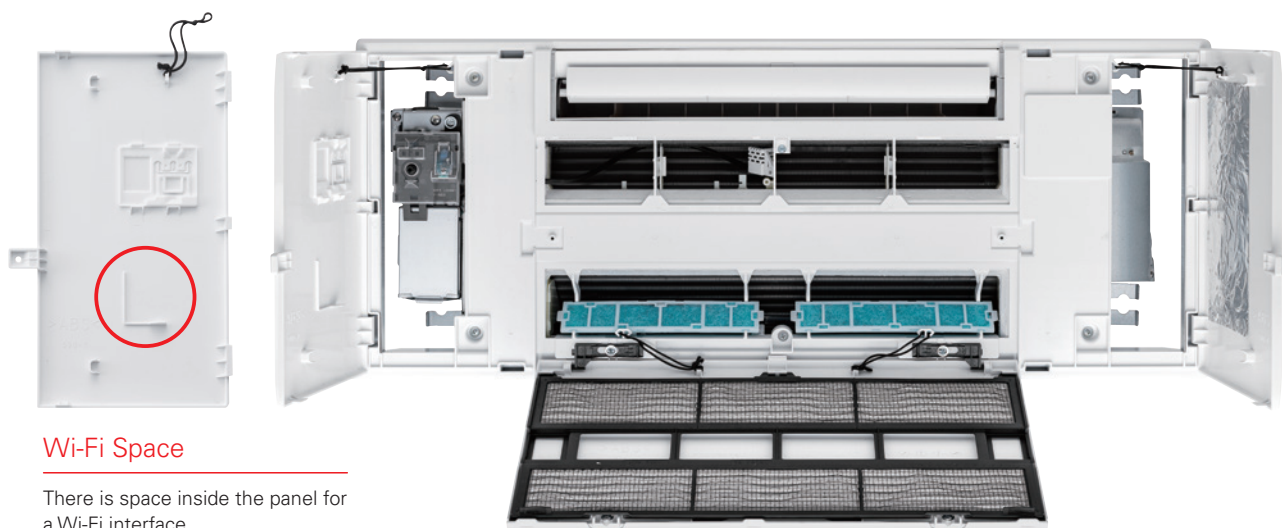

# MLZ SERIES



## Indoor Unit **R32**



MLZ-KP25/35/50VF



## **R32**



MLZ-KY20VG

## Panel

MLP-444W

MLP-448W

## Outdoor Unit



SUZ-M25/35VA



SUZ-M50VA

For Multi Connection Only

## Remote Controller



Built in MLZ-KP/KY



\*optional



\*optional



\*optional

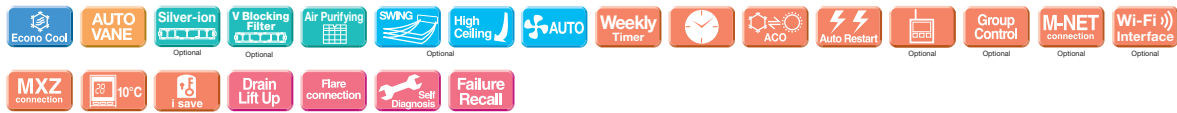

Type	Inverter Heat Pump							
Indoor Unit	MLZ-KY20VG	MLZ-KP25VF	MLZ-KP35VF	MLZ-KP50VF				
Outdoor Unit	For Multi connection only	SUZ-M25VA	SUZ-M35VA	SUZ-M50VA				
Refrigerant	R32 <sup>(1)</sup>							
Power Supply	Source	Outdoor Power supply						
	Outdoor ( V / Phase / Hz )	230 / Single / 50						
Cooling	Design load	kW	2.5	3.5	5.0			
	Annual electricity consumption <sup>(2)</sup>	kWh/a	141	175	260			
	SEER <sup>(4),(5)</sup>		6.2	7.0	6.7			
	Energy efficiency class			A++	A++	A++		
		Rated	kW	2.5	3.5	5.0		
Capacity	Min-Max	kW	1.4 - 3.2	0.8 - 3.9	1.7 - 5.6			
	Total Input	Rated	kW	0.59	0.94	1.38		
Heating (Average Season)	Design load	kW	2.2	2.6	4.3			
	Declared Capacity	at reference design temperature	kW	2.0 (-10°C)	2.3 (-10°C)	3.8 (-10°C)		
		at bivalent temperature	kW	2.0 (-7°C)	2.3 (-7°C)	3.8 (-7°C)		
		at operation limit temperature	kW	2.0 (-10°C)	2.3 (-10°C)	3.8 (-10°C)		
	Back up heating capacity	kW	0.2	0.3	0.5			
	Annual electricity consumption <sup>(2)</sup>	kWh/a	697	791	1397			
	SCOP <sup>(4),(5)</sup>		4.4	4.6	4.3			
	Energy efficiency class			A+	A+	A+		
		Rated	kW	3.2	4.1	6.0		
	Capacity	Min-Max	kW	1.4 - 4.2	1.1 - 4.9	1.7 - 7.2		
Total Input		Rated	kW	0.80	1.10	1.86		
Operating Current (Max)	Input	Rated	kW	0.012	0.04	0.04		
	Operating Current(Max)	A		0.12	0.40	0.40		
Indoor Unit	Dimensions	H*W*D	mm	194-842-301	185-1102-360	185-1102-360	185-1102-360	
	Weight		kg	14	15.5	15.5	15.5	
	Air Volume (SLo-Lo-Mid-Hi <sup>(3)</sup> )	Cooling	m <sup>3</sup> /min		4.3-4.7-5.2-5.6	6.0-7.2-8.0-8.8	6.0-7.3-8.4-9.4	6.0-8.3-9.8-11.4
		Heating	m <sup>3</sup> /min		4.3-4.9-5.5-6.0	6.0-7.0-8.2-9.2	6.0-7.7-8.8-9.9	6.0-8.8-10.3-11.8
	Sound Level (SPL) (SLo-Lo-Mid-Hi <sup>(3)</sup> )	Cooling	dB(A)		30-32-34-37	27-31-34-38	27-32-36-40	29-36-41-47
Heating		dB(A)		29-32-35-58	29-27-34-37	26-32-36-40	26-37-42-48	
Sound Level (PWL)	Cooling	dB(A)		40-42-44-50	52	53	59	
Panel	Dimensions	H*W*D	mm	34-915-370	24-1200-424	24-1200-424	24-1200-424	
	Weight		kg	3.8	3.5	3.5	3.5	
	Dimensions	H*W*D	mm		550-800-285	550-800-285	714-800-285	
	Weight		kg		30	35	41	
	Air Volume	Cooling	m <sup>3</sup> /min		36.3	34.3	45.8	
Heating		m <sup>3</sup> /min		34.6	32.7	43.7		
Sound Level (SPL)	Cooling	dB(A)		45	48	48		
	Heating	dB(A)		46	48	49		
Sound Level (PWL)	Cooling	dB(A)		59	59	64		
	Heating	dB(A)		59	59	64		
Operating Current (Max)		A		6.8	8.5	13.5		
	Breaker Size	A		10	10	20		
Ext. Piping	Diameter	Liquid/Gas	mm	6.35/9.52	6.35/9.52	6.35/9.52	6.35/12.7	
	Max.Length	Out-In	m		20	20	30	
	Max.Height	Out-In	m		12	12	30	
Guaranteed Operating Range (Outdoor)	Cooling	°C		-10~+46	-10~+46	-10~+46	-15~+46	
	Heating	°C		-10~+24	-10~+24	-10~+24	-10~+24	

# Specification on Warmer/Colder Condition

Type		Inverter Heat Pump				
Indoor Unit		MSZ-RW25VG	MSZ-RW35VG	MSZ-RW50VG		
Outdoor Unit		MUZ-RW25VGHZ	MUZ-RW35VGHZ	MUZ-RW50VGHZ		
Refrigerant		R32 <sup>(*)</sup>				
Cooling	Design load	kW	2.5	3.5	5.0	
	Annual electricity consumption <sup>(2)</sup>	kWh/a	78	130	230	
	SEER		11.2	9.4	7.6	
		Energy efficiency class	A+++	A+++	A++	
Heating (Warmer Season)	Design load	kW	1.8	2.2	3.3	
	Declared Capacity	at reference design temperature	kW	1.8	2.2	3.3
		at bivalent temperature	kW	1.8	2.2	3.3
		at operation limit temperature	kW	2.6	2.6	4.0
	Back up heating capacity	kW	0.0	0.0	0.0	
	Annual electricity consumption <sup>(2)</sup>	kWh/a	372	469	715	
SCOP		6.7	6.5	6.4		
		Energy efficiency class	A+++	A+++	A+++	
Heating (Colder Season)	Design load	kW	4.7	5.9	8.8	
	Declared Capacity	at reference design temperature	kW	3.7	4.0	5.6
		at bivalent temperature	kW	3.2	4.0	6.0
		at operation limit temperature	kW	2.6	2.6	4.0
	Back up heating capacity	kW	1.0	1.9	3.2	
	Annual electricity consumption <sup>(2)</sup>	kWh/a	2407	3083	5157	
SCOP		4.1	4.0	3.5		
		Energy efficiency class	A+	A+	A	

Type		Inverter Heat Pump								
Indoor Unit		MSZ-LN25VG2		MSZ-LN35VG2		MSZ-LN50VG2		MSZ-LN60VG2		
Outdoor Unit		MUZ-LN25VG2	MUZ-LN25VGHZ2	MUZ-LN35VG2	MUZ-LN35VGHZ2	MUZ-LN50VG2	MUZ-LN50VGHZ	MUZ-LN60VG2	MUZ-LN60VGHZ	
Refrigerant		R32 <sup>(*)</sup>								
Cooling	Design load	kW	2.5	2.5	3.5	3.5	5	5.0	6.1	
	Annual electricity consumption <sup>(2)</sup>	kWh/a	83	83	129	130	205	230	285	
	SEER		10.5	10.5	9.5	9.4	8.5	7.6	7.5	
		Energy efficiency class	A+++	A+++	A+++	A+++	A+++	A++	A++	
Heating (Warmer Season)	Design load	kW	1.7 (2°C)	1.8 (2°C)	2.0 (2°C)	2.2 (2°C)	2.5 (2°C)	3.3 (2°C)	3.3 (2°C)	
	Declared Capacity	at reference design temperature	kW	1.7 (2°C)	1.8 (2°C)	2.0 (2°C)	2.2 (2°C)	2.5 (2°C)	3.3 (2°C)	3.3 (2°C)
		at bivalent temperature	kW	1.7 (2°C)	1.8 (2°C)	2.0 (2°C)	2.2 (2°C)	2.5 (2°C)	3.3 (2°C)	3.3 (2°C)
		at operation limit temperature	kW	2.5 (-15°C)	2.3 (-25°C)	3.2 (-15°C)	3.1 (-25°C)	4.2 (-15°C)	4.7 (-25°C)	6.0 (-15°C)
	Back up heating capacity	kW	0.0 (2°C)	0.0 (2°C)	0.0 (2°C)	0.0 (2°C)	0.0 (2°C)	0.0 (2°C)	0.0 (2°C)	
	Annual electricity consumption <sup>(2)</sup>	kWh/a	369	382	431	467	602	779	779	
SCOP		6.4	6.6	6.5	6.5	5.8	5.9	5.9		
		Energy efficiency class	A+++	A+++	A+++	A+++	A+++	A+++		
Heating (Colder Season)	Design load	kW	—	4.7 (-22°C)	—	5.9 (-22°C)	—	8.8 (-22°C)	—	
	Declared Capacity	at reference design temperature	kW	—	2.6 (-22°C)	—	3.4 (-22°C)	—	5.1 (-22°C)	—
		at bivalent temperature	kW	—	3.2 (-10°C)	—	4.0 (-10°C)	—	6.0 (-10°C)	—
		at operation limit temperature	kW	—	2.3 (-25°C)	—	3.1 (-25°C)	—	4.7 (-25°C)	—
	Back up heating capacity	kW	—	2.1 (-22°C)	—	2.5 (-22°C)	—	3.7 (-22°C)	—	
	Annual electricity consumption <sup>(2)</sup>	kWh/a	—	2425	—	3075	—	5340	—	
SCOP		—	4.0	—	4.0	—	3.4	—		
		Energy efficiency class	—	A+	—	A+	—	A	—	

Type		Inverter Heat Pump				
Indoor Unit		MSZ-FT25VG	MSZ-FT35VG	MSZ-FT50VG		
Outdoor Unit		MUZ-FT25VGHZ	MUZ-FT35VGHZ	MUZ-FT50VGHZ		
Refrigerant		R32 <sup>(*)</sup>				
Cooling	Design load	kW	2.5	3.5	5.0	
	Annual electricity consumption <sup>(2)</sup>	kWh/a	101	142	243	
	SEER		8.6	8.6	7.2	
		Energy efficiency class	A+++	A+++	A++	
Heating (Warmer Season)	Design load	kW	1.8 (2°C)	2.2 (2°C)	2.7 (2°C)	
	Declared Capacity	at reference design temperature	kW	1.8 (2°C)	2.2 (2°C)	2.7 (2°C)
		at bivalent temperature	kW	1.8 (2°C)	2.2 (2°C)	2.7 (2°C)
		at operation limit temperature	kW	3.0 (-25°C)	3.4 (-25°C)	3.6 (-25°C)
	Back up heating capacity	kW	0.0 (2°C)	0.0 (2°C)	0.0 (2°C)	
	Annual electricity consumption <sup>(2)</sup>	kWh/a	432	527	684	
SCOP		5.8	5.8	5.5		
		Energy efficiency class	A+++	A+++	A+++	
Heating (Colder Season)	Design load	kW	4.7 (-22°C)	5.9 (-22°C)	7.4 (-22°C)	
	Declared Capacity	at reference design temperature	kW	3.1 (-22°C)	3.7 (-22°C)	4.0 (-22°C)
		at bivalent temperature	kW	3.2 (-10°C)	4.0 (-10°C)	5.0 (-10°C)
		at operation limit temperature	kW	3.0 (-25°C)	3.4 (-25°C)	3.6 (-25°C)
	Back up heating capacity	kW	1.6 (-22°C)	2.2 (-22°C)	3.4 (-22°C)	
	Annual electricity consumption <sup>(2)</sup>	kWh/a	2766	3453	4707	
SCOP		3.5	3.5	3.3		
		Energy efficiency class	A	A	B	

Type		Inverter Heat Pump											
Indoor Unit		MSZ-AY15VGK(P)	MSZ-AY20VGK(P)	MSZ-AY25VGK(P)	MSZ-AY25VGK(P)	MSZ-AY35VGK(P)	MSZ-AY35VGK(P)	MSZ-AY42VGK(P)	MSZ-AY42VGK(P)	MSZ-AY50VGK(P)	MSZ-AY50VGK(P)		
Outdoor Unit		MUZ-AY15VGHZ	MUZ-AY20VGHZ	MUZ-AY25VGHZ	MUZ-AY25VGHZ	MUZ-AY35VGHZ	MUZ-AY35VGHZ	MUZ-AY42VGHZ	MUZ-AY42VGHZ	MUZ-AY50VGHZ	MUZ-AY50VGHZ		
Refrigerant		R32 <sup>(*)</sup>											
Cooling	Design load	kW	—	—	2.5	2.5	3.5	3.5	4.2	4.2	5.0	5.0	
	Annual electricity consumption <sup>(2)</sup>	kWh/a	—	—	100	100	141	141	186	186	232	232	
	SEER <sup>(4)</sup>		—	—	8.7	8.7	8.7	8.7	7.9	7.9	7.5	7.5	
		Energy efficiency class	—	—	A+++	A+++	A+++	A+++	A++	A++	A++	A++	
Heating (Warmer Season)	Design load	kW	0.9 (2°C)	1.3 (2°C)	1.3 (2°C)	1.3 (2°C)	1.6 (2°C)	1.6 (2°C)	2.1 (2°C)	2.1 (2°C)	2.3 (2°C)	2.3 (2°C)	
	Declared Capacity	at reference design temperature	kW	0.9 (2°C)	1.3 (2°C)	1.3 (2°C)	1.3 (2°C)	1.6 (2°C)	1.6 (2°C)	2.1 (2°C)	2.1 (2°C)	2.3 (2°C)	2.3 (2°C)
		at bivalent temperature	kW	0.9 (2°C)	1.3 (2°C)	1.3 (2°C)	1.3 (2°C)	1.6 (2°C)	1.6 (2°C)	2.1 (2°C)	2.1 (2°C)	2.3 (2°C)	2.3 (2°C)
		at operation limit temperature	kW	1.6 (-15°C)	1.8 (-20°C)	1.9 (-20°C)	1.9 (-20°C)	2.0 (-20°C)	2.0 (-20°C)	2.7 (-20°C)	2.7 (-20°C)	3.0 (-20°C)	3.0 (-20°C)
	Back up heating capacity	kW	0.0 (2°C)	0.0 (2°C)	0.0 (2°C)	0.0 (2°C)	0.0 (2°C)	0.0 (2°C)	0.0 (2°C)	0.0 (2°C)	0.0 (2°C)	0.0 (2°C)	
	Annual electricity consumption <sup>(2)</sup>	kWh/a	267	350	319	319	376	376	495	495	523	523	
SCOP		4.7	5.2	5.7	5.7	5.9	5.9	5.9	5.9	6.1	6.1		
		Energy efficiency class	A++	A+++	A+++	A+++	A+++	A+++	A+++	A+++	A+++	A+++	

Type		Inverter Heat Pump		
Indoor Unit		MSZ-AP60VG(K)	MSZ-AP71VG(K)	
Outdoor Unit		MUZ-AP60VG	MUZ-AP71VG	
Refrigerant		R32 <sup>(*)</sup>		
Cooling	Design load	kW	6.1	
	Annual electricity consumption <sup>(2)</sup>	kWh/a	288	
	SEER		7.4	
		Energy efficiency class	A++	
Heating (Warmer Season)	Design load	kW	2.5 (2°C)	
	Declared Capacity	at reference design temperature	kW	2.5 (2°C)
		at bivalent temperature	kW	2.5 (2°C)
		at operation limit temperature	kW	3.7 (-15°C)
	Back up heating capacity	kW	0.0 (2°C)	
	Annual electricity consumption <sup>(2)</sup>	kWh/a	627	
	SCOP		5.5	
		Energy efficiency class	A+++	

Type		Inverter Heat Pump						
Indoor Unit		MSZ-EF25VG		MSZ-EF35VG		MSZ-EF42VG		
Outdoor Unit		MUZ-EF25VG	MUZ-EF25VGH	MUZ-EF35VG	MUZ-EF35VGH	MUZ-EF42VG	MUZ-EF50VG	
Refrigerant		R32 <sup>(*)</sup>						
Cooling	Design load	kW	2.5	2.5	3.5	3.5	4.2	
	Annual electricity consumption <sup>(2)</sup>	kWh/a	96	96	139	139	186	
	SEER		9.1	9.1	8.8	8.8	7.9	
		Energy efficiency class	A+++	A+++	A+++	A+++	A++	
Heating (Warmer Season)	Design load	kW	1.3 (2°C)	1.3 (2°C)	1.6 (2°C)	1.6 (2°C)	2.1 (2°C)	
	Declared Capacity	at reference design temperature	kW	1.3 (2°C)	1.3 (2°C)	1.6 (2°C)	1.6 (2°C)	2.1 (2°C)
		at bivalent temperature	kW	1.3 (2°C)	1.3 (2°C)	1.6 (2°C)	1.6 (2°C)	2.1 (2°C)
		at operation limit temperature	kW	2.0 (-15°C)	2.0 (-15°C)	2.4 (-15°C)	2.4 (-15°C)	3.4 (-15°C)
	Back up heating capacity	kW	0.0 (2°C)	0.0 (2°C)	0.0 (2°C)	0.0 (2°C)	0.0 (2°C)	
	Annual electricity consumption <sup>(2)</sup>	kWh/a	311	311	398	398	489	
	SCOP		5.9	5.9	5.6	5.6	6.0	
		Energy efficiency class	A+++	A+++	A+++	A+++	A+++	

Type		Inverter Heat Pump				
Indoor Unit		MSZ-BT20VG	MSZ-BT25VG	MSZ-BT35VG	MSZ-BT50VG	
Outdoor Unit		MUZ-BT20VG	MUZ-BT25VG	MUZ-BT35VG	MUZ-BT50VG	
Refrigerant		R32 <sup>(*)</sup>				
Cooling	Design load	kW	2.0	2.5	3.5	
	Annual electricity consumption <sup>(2)</sup>	kWh/a	86	108	180	
	SEER		8.1	8.1	6.8	
		Energy efficiency class	A++	A++	A++	
Heating (Warmer Season)	Design load	kW	0.9 (2°C)	1.1 (2°C)	1.3 (2°C)	
	Declared Capacity	at reference design temperature	kW	0.9 (2°C)	1.1 (2°C)	1.3 (2°C)
		at bivalent temperature	kW	0.9 (2°C)	1.1 (2°C)	1.3 (2°C)
		at operation limit temperature	kW	1.3 (-15°C)	1.7 (-15°C)	2.1 (-15°C)
	Back up heating capacity	kW	0.0 (2°C)	0.0 (2°C)	0.0 (2°C)	
	Annual electricity consumption <sup>(2)</sup>	kWh/a	234	268	304	
	SCOP <sup>(*)</sup>		5.3	5.7	5.9	
		Energy efficiency class	A+++	A+++	A+++	

Type		Inverter Heat Pump					
Indoor Unit		MSZ-HR25VF	MSZ-HR35VF	MSZ-HR42VF	MSZ-HR50VF	MSZ-HR60VF	MSZ-HR71VF
Outdoor Unit		MUZ-HR25VF	MUZ-HR35VF	MUZ-HR42VF	MUZ-HR50VF	MUZ-HR60VF	MUZ-HR71VF
Refrigerant		R32 <sup>(*)</sup>					
Cooling	Design load	kW	2.5	3.4	4.2	5.0	6.1
	Annual electricity consumption <sup>(2)</sup>	kWh/a	141	191	226	269	296
	SEER		6.2	6.2	6.5	6.5	7.2
		Energy efficiency class	A++	A++	A++	A++	A++
Heating (Warmer Season)	Design load	kW	1.1 (2°C)	1.3 (2°C)	1.6 (2°C)	2.1 (2°C)	2.5 (2°C)
	Declared Capacity	at reference design temperature	kW	1.1 (2°C)	1.3 (2°C)	1.6 (2°C)	2.1 (2°C)
		at bivalent temperature	kW	1.1 (2°C)	1.3 (2°C)	1.6 (2°C)	2.1 (2°C)
		at operation limit temperature	kW	1.9 (-10°C)	2.4 (-10°C)	2.9 (-10°C)	3.8 (-10°C)
	Back up heating capacity	kW	0.0 (2°C)	0.0 (2°C)	0.0 (2°C)	0.0 (2°C)	0.0 (2°C)
	Annual electricity consumption <sup>(2)</sup>	kWh/a	289	344	427	558	640
	SCOP		5.3	5.2	5.2	5.2	5.4
		Energy efficiency class	A+++	A+++	A+++	A+++	A+++

Type		Inverter Heat Pump			
Indoor Unit		MSZ-DW25VF	MSZ-DW35VF	MSZ-DW50VF	
Outdoor Unit		MUZ-DW25VF	MUZ-DW35VF	MUZ-DW50VF	
Refrigerant		R32 <sup>(*)</sup>			
Cooling	Design load	kW	2.5	3.4	
	Annual electricity consumption <sup>(2)</sup>	kWh/a	135	184	
	SEER		6.2	6.2	
		Energy efficiency class	A++	A++	
Heating (Warmer Season)	Design load	kW	1.1 (2°C)	1.3 (2°C)	
	Declared Capacity	at reference design temperature	kW	1.1 (2°C)	1.3 (2°C)
		at bivalent temperature	kW	1.1 (2°C)	1.3 (2°C)
		at operation limit temperature	kW	1.9 (-10°C)	2.4 (-10°C)
	Back up heating capacity	kW	0.0 (2°C)	0.0 (2°C)	
	Annual electricity consumption <sup>(2)</sup>	kWh/a	287	351	
	SCOP		5.3	5.1	
		Energy efficiency class	A+++	A+++	

(\*) Refrigerant leakage contributes to climate change. Refrigerant with lower global warming potential (GWP) would contribute less to global warming than a refrigerant with higher GWP, if leaked to the atmosphere. This appliance contains a refrigerant fluid with a GWP equal to 1975. This means that if 1 kg of this refrigerant fluid would be leaked to the atmosphere, the impact on global warming would be 1975 times higher than 1 kg of CO<sub>2</sub>, over a period of 100 years. Never try to interfere with the refrigerant circuit yourself or disassemble the product yourself and always ask a professional.

(2) Energy consumption based on standard test results. Actual energy consumption will depend on how the appliance is used and where it is located.

(3) Refrigerant leakage contributes to climate change. Refrigerant with lower global warming potential (GWP) would contribute less to global warming than a refrigerant with higher GWP, if leaked to the atmosphere. This appliance contains a refrigerant fluid with a GWP equal to 550. This means that if 1 kg of this refrigerant fluid would be leaked to the atmosphere, the impact on global warming would be 550 times higher than 1 kg of CO<sub>2</sub>, over a period of 100 years. Never try to interfere with the refrigerant circuit yourself or disassemble the product yourself and always ask a professional.

# S

SERIES







# SELECTION

Series line-up consists of two types of indoor units.  
Choose the model that best matches room conditions.

**SELECT INDOOR UNIT**

Select the optimal unit and capacity required to match room construction and air conditioning requirements.

<div style="text-align: center;"> <span style="background-color: #00a651; color: white; border-radius: 50%; padding: 2px 5px;">R32</span>  <span style="background-color: #e91e63; color: white; border-radius: 50%; padding: 2px 5px;">R410A</span> </div> <div style="text-align: center; margin: 10px 0;">  </div> <p><b>Units without Remote Controller</b>            SLZ-M15FA2            (Multi split series connection only)            SLZ-M25FA2            SLZ-M35FA2            SLZ-M50FA2            SLZ-M60FA2</p> <p><b>Panel</b></p> <table border="1" style="width: 100%; border-collapse: collapse; text-align: center;"> <thead> <tr> <th>Panel</th> <th>With Signal Receiver</th> <th>With 3D i-see Sensor</th> <th>With Wireless Remote Controller</th> <th>With Plasma Quad Connect</th> </tr> </thead> <tbody> <tr><td>SLP-2FA</td><td></td><td></td><td></td><td></td></tr> <tr><td>SLP-2FAL</td><td>✓</td><td></td><td></td><td></td></tr> <tr><td>SLP-2FAE</td><td></td><td>✓</td><td></td><td></td></tr> <tr><td>SLP-2FALE</td><td>✓</td><td>✓</td><td></td><td></td></tr> <tr><td>SLP-2FALM2</td><td>✓</td><td></td><td>✓</td><td></td></tr> <tr><td>SLP-2FALME2</td><td>✓</td><td>✓</td><td>✓</td><td></td></tr> <tr><td>SLP-2FAP</td><td></td><td></td><td></td><td>✓</td></tr> <tr><td>SLP-2FALP</td><td>✓</td><td></td><td></td><td>✓</td></tr> <tr><td>SLP-2FALMP2</td><td>✓</td><td></td><td>✓</td><td>✓</td></tr> </tbody> </table>	Panel	With Signal Receiver	With 3D i-see Sensor	With Wireless Remote Controller	With Plasma Quad Connect	SLP-2FA					SLP-2FAL	✓				SLP-2FAE		✓			SLP-2FALE	✓	✓			SLP-2FALM2	✓		✓		SLP-2FALME2	✓	✓	✓		SLP-2FAP				✓	SLP-2FALP	✓			✓	SLP-2FALMP2	✓		✓	✓	<div style="text-align: center;"> <span style="background-color: #00a651; color: white; border-radius: 50%; padding: 2px 5px;">R32</span>  <span style="background-color: #e91e63; color: white; border-radius: 50%; padding: 2px 5px;">R410A</span> </div> <div style="text-align: center; margin: 10px 0;">  </div> <p><b>Units without Remote Controller</b>            SEZ-M25DA2            SEZ-M35DA2            SEZ-M50DA2            SEZ-M60DA2            SEZ-M71DA2</p> <p><b>Units with Wireless Remote Controller</b>            SEZ-M25DAL2            SEZ-M35DAL2            SEZ-M50DAL2            SEZ-M60DAL2            SEZ-M71DAL2</p>	<div style="text-align: center;"> <span style="background-color: #00a651; color: white; border-radius: 50%; padding: 2px 5px;">R32</span> </div> <div style="text-align: center; margin: 10px 0;">  </div> <p><b>Units without Remote Controller</b>            SFZ-M25VA            SFZ-M35VA            SFZ-M50VA            SFZ-M60VA            SFZ-M71VA</p>
Panel	With Signal Receiver	With 3D i-see Sensor	With Wireless Remote Controller	With Plasma Quad Connect																																																
SLP-2FA																																																				
SLP-2FAL	✓																																																			
SLP-2FAE		✓																																																		
SLP-2FALE	✓	✓																																																		
SLP-2FALM2	✓		✓																																																	
SLP-2FALME2	✓	✓	✓																																																	
SLP-2FAP				✓																																																
SLP-2FALP	✓			✓																																																
SLP-2FALMP2	✓		✓	✓																																																

**SELECT OUTDOOR UNIT**

There is one outdoor unit for respective indoor units.

<div style="text-align: center;"> <span style="background-color: #00a651; color: white; border-radius: 50%; padding: 2px 5px;">R32</span> </div> <div style="text-align: center; margin: 10px 0;">  </div> <p>SUZ-M25/35VA</p>	<div style="text-align: center;"> <span style="background-color: #00a651; color: white; border-radius: 50%; padding: 2px 5px;">R32</span> </div> <div style="text-align: center; margin: 10px 0;">  </div> <p>SUZ-M50VA</p>	<div style="text-align: center;"> <span style="background-color: #00a651; color: white; border-radius: 50%; padding: 2px 5px;">R32</span> </div> <div style="text-align: center; margin: 10px 0;">  </div> <p>SUZ-M60/71VA</p>
---	--	---

\* To confirm compatibility with the MXZ Series multi-type system, refer to the MXZ Series page.

# SLZ SERIES

R32  
R410A

SLZ-M15/25/35/50/60FA2



Compact, lightweight ceiling cassette units with 4-way air outlets provide maximum comfort by evenly distributing airflow throughout the entire room.

## 2x2 Cassette Line-up

The SLZ series was previously only able to be connected to standard inverters and some power inverters. However, it can now also be connected to low-capacity power inverters. The ability to connect to a high-performance power inverter allows us to offer a wider range of options to our customers.

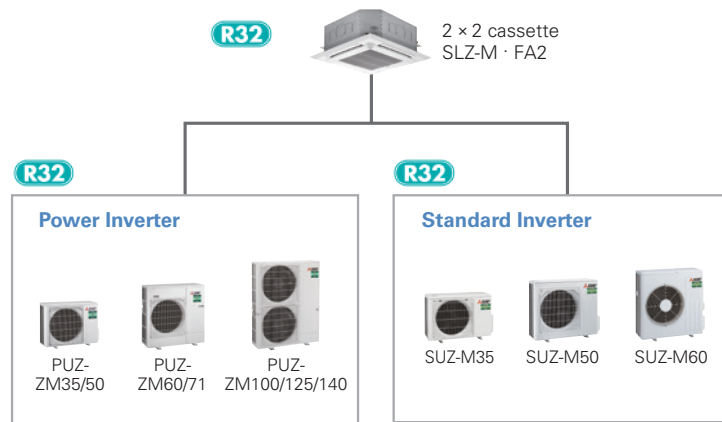

## New lineup

1.5kW has been introduced for multi connection. The diverse selection enables the best solution for both customer and location.

Capacity	15	25	35	50	60
SLZ-KF		✓	✓	✓	✓
SLZ-M	✓	✓	✓	✓	✓

## Beautiful design

The straight-line form introduced has resulted in a beautiful square design. Its high affinity ensures the ability to blend in seamlessly with any interior. The indoor unit is an ideal match for office or store use. Of course, design matched 2x2 (600mm\*600mm) ceiling construction specifications.

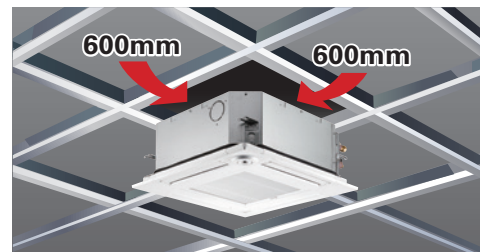

## The height above ceiling of 245mm

The height above ceiling of 245mm enables fitting into narrow ceiling space. Installation is simple, even when the ceiling spaces are narrow to make the ceilings higher. Of course, in addition to our products, replacing competitors' product is simplified too.

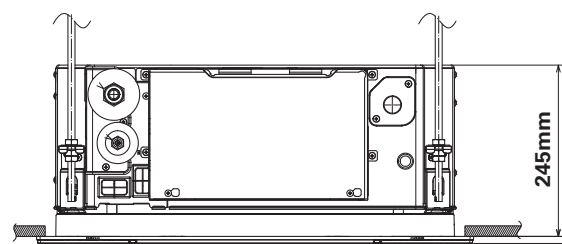

## Energy-saving Performance\*

The energy-saving performance achieved A++ in SEER and A+ in SCOP.

\*In case of connecting with SUZ-KA-VA6

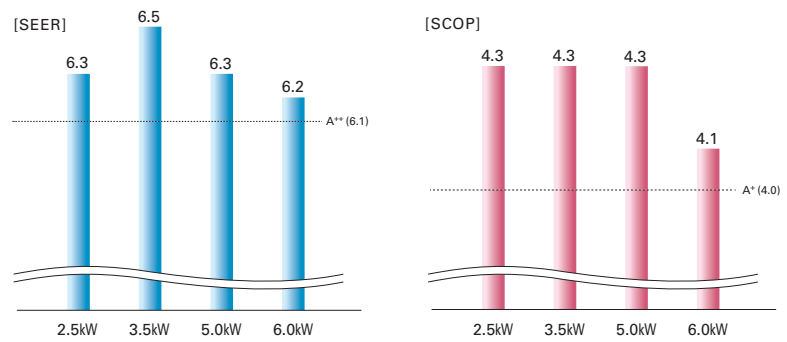

## Quietness

Low sound level has been realized by introduction of 3D turbo fan. New SLZ can give users quieter and more comfortable room condition.



## Horizontal Airflow

The new airflow control completely eliminates that uncomfortable drafty-feeling with the introduction of a horizontal airflow that spreads across the ceiling. The ideal airflow for offices and restaurants.

[Airflow distribution]\*

SLZ-M60FA

Flow angle, cooling at 20°C (ceiling height 2.7m)

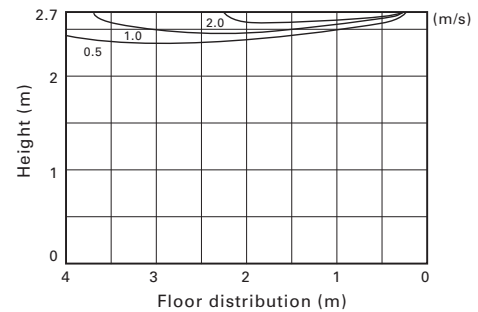

\*Vane angle: Horizontal

## Easy installation

### Temporary hanging hook

The structure of the panel has been revised and is now equipped with a temporary hanging hook. This has improved work efficiency during temporary panel installation.



### No need to remove screws

Installation is possible without removing the screws for control box simply loosen them. This eliminates the risk of losing screws.

■ Corner panel

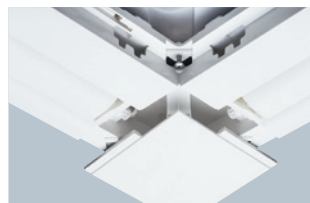

■ Control box cover



## Drain lift

As the result of using a larger drain pan, the maximum drain lifting height has been up to 850mm, greatly enhancing construction flexibility compared to the existing model.

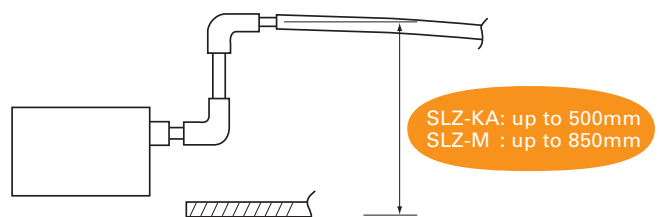

## Detects number of people

### Room occupancy energy-saving mode

The 3D i-see Sensor detects the number of people in the room. It then calculates the occupancy rate based on the maximum number of people in the room up to that point in time in order to save air-conditioning power. When the occupancy rate is approximately 30%, air-conditioning power equivalent to 1°C during both cooling and heating operation is saved. The temperature is controlled according to the number of people.

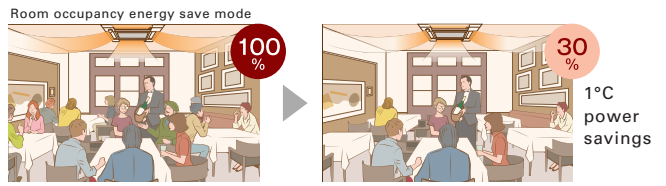

### No occupancy energy-saving mode

When 3D i-see Sensor detects that no one is in the room, the system is switched to a pre-set power-saving mode. If the room remains unoccupied for more than 60min, air-conditioning power equivalent to 2°C during both cooling and heating operation is saved. This contributes to preventing waste in terms of heating and cooling.

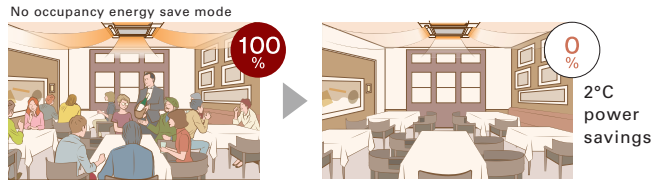

### No occupancy Auto-OFF mode\*

When the room remains unoccupied for a pre-set period of time, the air conditioner turns off automatically, thereby providing even greater power savings. The time until operation is stopped can be set in intervals of 10min, ranging from 60 to 180 min.

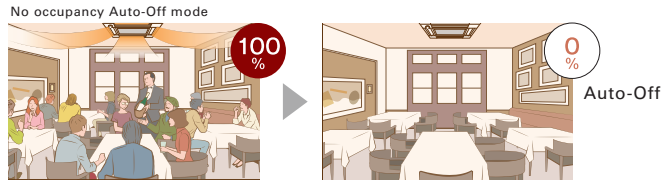

\* When MA Remote Controller is used to control multiple refrigerant systems, "No occupancy Auto-OFF mode" cannot be used.

\*PAR-41MAA is required for each setting

## Detects people's position

### Direct/Indirect settings\*

Some people do not like the feel of wind, some want to be warm from head to toe. People's likes and dislikes vary. With the 3D i-see Sensor, it is possible to choose to block or not block to the wind for each vane.

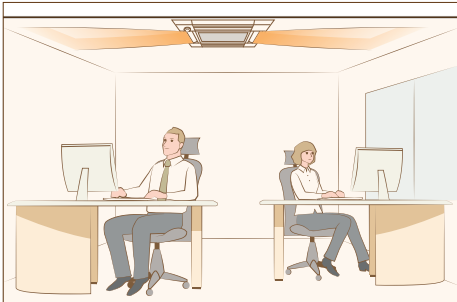

\*PAR-41MAA or PAR-SL101A-E is required for each setting.

### Seasonal airflow\*

#### <When cooling>

Saves energy while keeping a comfortable effective temperature by automatically switching between ventilation and cooling. When a pre-set temperature is reached, the air conditioning unit switches to swing fan operation to maintain the effective temperature. This clever function contributes to keeping a comfortable coolness.

#### <When heating>

The air conditioning unit automatically switches between circulator and heating. Wasted heat that accumulates near the ceiling is reused via circulation. When a pre-set temperature is reached the air conditioner switches from heating to circulator and blows air in the horizontal direction. It pushes down the warm air that has gathered near the ceiling to people's height, thereby providing smart heating.

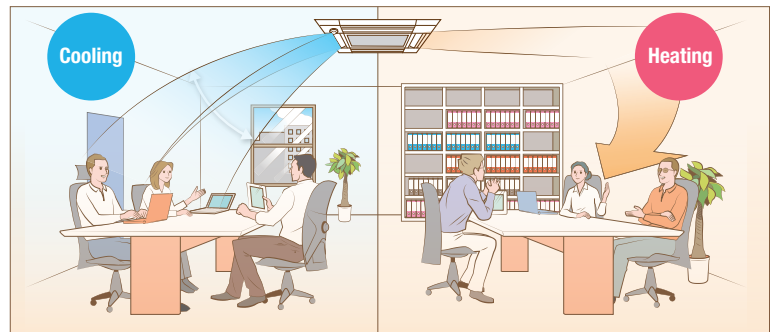

\*PAR-41MAA is required for each setting.

## Connectable to Plasma Quad Connect

The optional Plasma Quad Connect SLP-2FAP, SLP-2FALP, SLP-2FALMP2 can be installed on the indoor units.\*1\*2\*3

\*1 Plasma Quad Connect cannot be used with PAC-SK54/46KF-E (V blocking filter).

\*2 If Plasma Quad Connect is used with MAC-334/397/5871F-E (Interface), Plasma Quad Connect use the indoor units CN105. Other interface use the another CN105 on Plasma Quad Connect's PCB.

\*3 If Plasma Quad Connect is used with PAC-SK35VK-E (Valve kit) or PAC-SK39AP-E (Valve kit attachment), Plasma Quad Connect use the indoor units barring holes for valve kit. Valve kit needs to be installed on suspension bolts or on horizontal surface using dedicated attachment optional parts.



# SLZ-M SERIES



## Indoor Unit

R32  
R410A



SLZ-M15/25/35/50/60FA2

### Panel

Panel	With Signal Receiver	With 3D i-see Sensor	With Wireless Remote Controller	With Plasma Quad Connect
SLP-2FA				
SLP-2FAL	✓			
SLP-2FAE		✓		
SLP-2FALE	✓	✓		
SLP-2FALM2	✓		✓	
SLP-2FALME2	✓	✓	✓	
SLP-2FAP				✓
SLP-2FALP	✓			✓
SLP-2FALMP2	✓		✓	✓

## Outdoor Unit

R32 For Single

R32 For Multi (Twin/Triple/Quadruple)



### Remote Controller



Indoor Unit Combination	Outdoor Unit Capacity														
	For Single							For Twin			For Triple		For Quadruple		
	35	50	60	71	100	125	140	71	100	125	100	125	140	125	140
Power Inverter (PUZ-ZM)	35x1	50x1	60x1	-	-	-	-	35x2	50x2	60x2	35x3	50x3	50x3	35x4	35x4
Distribution Pipe	-	-	-	-	-	-	-	MSDD-50TR2-E			MSDF-111R3-E		MSDF-111R2-E		

Type			Inverter Heat Pump					
Indoor Unit			SLZ-M35FA2		SLZ-M50FA2		SLZ-M60FA2	
Outdoor Unit			PUZ-ZM35VKA2		PUZ-ZM50VKA2		PUZ-ZM60VHA2	
Refrigerant <sup>(1)</sup>			R32					
Power Supply	Source	Outdoor power supply						
Cooling	Outdoor(V/Phase/Hz)	230/Single/50						
	Capacity	Rated	kW	3.6	5.0	6.1		
		Min-Max	kW	1.6 - 4.5	2.3 - 5.6	2.7 - 6.5		
	Total Input	Rated	kW	0.800	1.315	1.648		
	EER			4.50	3.80	3.70		
	Design load		kW	3.6	5.0	6.1		
	Annual electricity consumption <sup>(2)</sup>		kWh/a	194	280	346		
SEER <sup>(4)</sup>			6.5	6.2	6.1			
Heating			Energy efficiency class					
	Capacity	Rated	kW	4.1	5.0	6.4		
		Min-Max	kW	1.6 - 5.0	2.5 - 5.5	2.8 - 7.3		
	Total Input	Rated	kW	1.205	1.470	2.064		
	COP			3.40	3.40	3.10		
	Design load		kW	2.4	3.8	4.4		
	Declared Capacity	at reference design temperature	kW	2.4 (-10°C)	3.8 (-10°C)	4.4 (-10°C)		
		at bivalent temperature	kW	2.4 (-10°C)	3.8 (-10°C)	4.4 (-10°C)		
		at operation limit temperature	kW	2.2 (-11°C)	3.7 (-11°C)	2.8 (-20°C)		
	Back up heating capacity		kW	0.0	0.0	0.0		
Annual electricity consumption <sup>(2)</sup>		kWh/a	820	1273	1560			
SCOP <sup>(4)</sup>			4.0	4.1	3.9			
		Energy efficiency class						
Operating Current(Max)		A	13.2	13.3	19.4			
Indoor Unit	Input [cooling / Heating]	Rated	kW	0.02 / 0.02	0.03 / 0.03	0.04 / 0.04		
	Operating Current(Max)		A	0.24	0.32	0.43		
	Dimensions	H*W*D	mm	245-570-570 <10-625-625>	245-570-570 <10-625-625>	245-570-570 <10-625-625>		
	Weight		kg	15 <3>	15 <3>	15 <3>		
	Air Volume (Lo-Mi2-Mi1-Hi)		m³/min	6.5-8.0-9.5	7.0-9.0-11.5	7.5-11.5-13.0		
	Sound Level (Lo-Mi2-Mi1-Hi) (SPL)		dB(A)	25-30-34	27-34-39	32-40-43		
	Sound Level (PWL)		dB(A)	51	56	60		
Outdoor Unit	Dimensions	H*W*D	mm	630-809-300	630-809-300	943-950-330(+25)		
	Weight		kg	46	46	67		
	Air Volume	Cooling	m³/min	45	45	55		
		Heating	m³/min	45	45	55		
	Sound Level (SPL)	Cooling	dB(A)	44	44	47		
		Heating	dB(A)	46	46	49		
	Sound Level (PWL)	Cooling	dB(A)	65	65	67		
		Heating	dB(A)	65	65	67		
	Operating Current(Max)		A	13	13	19		
	Breaker Size		A	16	16	25		
Ext.Piping	Diameter <sup>(3)</sup>	Liquid/Gas	mm	6.35 / 12.7	6.35 / 12.7	9.52 / 15.88		
	Max.Length	Out-In	m	50	50	55		
	Max.Height	Out-In	m	30	30	30		
Guaranteed Operating Range (Outdoor)	Cooling <sup>(2)</sup>	°C	-15 ~ +46	-15 ~ +46	-15 ~ +46			
	Heating	°C	-11 ~ +21	-11 ~ +21	-20 ~ +21			

\*1 Refrigerant leakage contributes to climate change. Refrigerant with lower global warming potential (GWP) would contribute less to global warming than a refrigerant with higher GWP, if leaked to the atmosphere. This appliance contains a refrigerant fluid with a GWP equal to 1975. This means that if 1 kg of this refrigerant fluid would be leaked to the atmosphere, the impact on global warming would be 1975 times higher than 1 kg of CO<sub>2</sub> over a period of 100 years. Never try to interfere with the refrigerant circuit yourself or disassemble the product yourself and always ask a professional. The GWP of R410A is 2088 in the IPCC 4th Assessment Report.

\*2 Energy consumption based on standard test results. Actual energy consumption will depend on how the appliance is used and where it is located.

\*3 Optional air protection guide is required where ambient temperature is lower than -5°C.

\*4 SEER and SCOP are based on 2009/125/EC:Energy-related Products Directive and Regulation(EU) No206/2012.

\*5 Joint pipe is required depending on installed refrigerant pipes, outdoor units and indoor units.

# SLZ-M SERIES



## Indoor Unit

R32  
R410A



SLZ-M15/25/35/50/60FA2

## Panel

Panel	With Signal Receiver	With 3D i-see Sensor	With Wireless Remote Controller	With Plasma Quad Connect
SLP-2FA				
SLP-2FAL	✓			
SLP-2FAE				
SLP-2FALE	✓	✓		
SLP-2FALM2	✓		✓	
SLP-2FALME2	✓	✓	✓	
SLP-2FAP				✓
SLP-2FALP	✓			✓
SLP-2FALMP2	✓		✓	✓

## Outdoor Unit

For Single



## Remote Controller



Indoor Unit Combination	Outdoor Unit Capacity				
	25	35	50	60	71
S Seires	25x1	35x1	50x1	60x1	-
Distribution Pipe	-	-	-	-	-

Type	Inverter Heat Pump							
Indoor Unit	SLZ-M25FA2	SLZ-M35FA2	SLZ-M50FA2	SLZ-M60FA2				
Outdoor Unit	SUZ-M25VA	SUZ-M35VA	SUZ-M50VA	SUZ-M60VA				
Refrigerant <sup>(1)</sup>	R32							
Power Supply	Outdoor power supply							
Source	230/Single/50							
Outdoor(V/Phase/Hz)								
Cooling	Capacity	Rated	kW	2.5	3.5	4.6	5.7	
	Total Input	Rated	kW	0.657	1.093	1.352	1.676	
		EER			3.80	3.20	3.40	3.40
	Design load		kW	2.5	3.5	4.6	5.7	
	Annual electricity consumption <sup>(2)</sup>		kWh/a	139	183	253	321	
	SEER <sup>(4)</sup>			6.3	6.7	6.3	6.2	
	Heating	Capacity	Rated	kW	3.2	4.0	5.0	6.4
			Min-Max	kW	1.3 - 4.2	1.0 - 5.0	1.3 - 5.5	1.6 - 7.3
		Total Input	Rated	kW	0.886	1.078	1.562	2.133
		COP			3.61	3.71	3.20	3.00
Design load			kW	2.2	2.6	3.6	4.6	
Declared Capacity		at reference design temperature	kW	2.0 (-10°C)	2.3 (-10°C)	3.2 (-10°C)	4.1 (-10°C)	
		at bivalent temperature	kW	2.0 (-7°C)	2.3 (-7°C)	3.2 (-7°C)	4.1 (-7°C)	
		at operation limit temperature	kW	2.0 (-10°C)	2.3 (-10°C)	3.2 (-10°C)	4.1 (-10°C)	
Back up heating capacity			kW	0.2	0.3	0.4	0.5	
Annual electricity consumption <sup>(2)</sup>			kWh/a	716	845	1192	1560	
SCOP <sup>(4)</sup>			4.3	4.3	4.2	4.1		
Operating Current(Max)	Input [cooling / Heating]	Rated	kW	0.02 / 0.02	0.02 / 0.02	0.03 / 0.03	0.04 / 0.04	
		Operating Current(Max)	A	0.20	0.24	0.32	0.43	
	Dimensions	H*W*D	mm	245-570-570 <10-625-625>	245-570-570 <10-625-625>	245-570-570 <10-625-625>	245-570-570 <10-625-625>	
	Weight		kg	15 <3>	15 <3>	15 <3>	15 <3>	
	Air Volume (Lo-Mi2-Mi1-Hi)		m³/min	6.5-7.5-8.5	6.5-8.0-9.5	7.0-9.0-11.5	7.5-11.5-13.0	
	Sound Level (Lo-Mi2-Mi1-Hi) (SPL)		dB(A)	25-28-31	25-30-34	27-34-39	32-40-43	
	Sound Level (PWL)		dB(A)	48	51	56	60	
	Outdoor Unit	Dimensions	H*W*D	mm	550-800-285	550-800-285	714-800-285	880-840-330
		Weight		kg	30	35	41	54
		Air Volume	Cooling	m³/min	36.3	34.3	45.8	50.1
Heating			m³/min	34.6	32.7	43.7	50.1	
Sound Level (SPL)		Cooling	dB(A)	45	48	48	49	
		Heating	dB(A)	46	48	49	51	
Sound Level (PWL)		Cooling	dB(A)	59	59	64	65	
		Operating Current(Max)		A	6.8	8.5	13.5	14.8
Breaker Size			A	10	10	20	20	
Ext.Piping		Diameter <sup>(5)</sup>	Liquid/Gas	mm	6.35 / 9.52	6.35 / 9.52	6.35 / 12.7	6.35 / 15.88
	Max.Length	Out-In	m	20	20	30	30	
	Max.Height	Out-In	m	12	12	30	30	
Guaranteed Operating Range (Outdoor)	Cooling <sup>(3)</sup>	°C		-10 ~ +46	-10 ~ +46	-15 ~ +46	-15 ~ +46	
	Heating	°C		-10 ~ +24	-10 ~ +24	-10 ~ +24	-10 ~ +24	

\*1 Refrigerant leakage contributes to climate change. Refrigerant with lower global warming potential (GWP) would contribute less to global warming than a refrigerant with higher GWP, if leaked to the atmosphere. This appliance contains a refrigerant fluid with a GWP equal to 1975. This means that if 1 kg of this refrigerant fluid would be leaked to the atmosphere, the impact on global warming would be 1975 times higher than 1 kg of CO<sub>2</sub> over a period of 100 years. Never try to interfere with the refrigerant circuit yourself or disassemble the product yourself and always ask a professional. The GWP of R410A is 2088 in the IPCC 4th Assessment Report.

\*2 Energy consumption based on standard test results. Actual energy consumption will depend on how the appliance is used and where it is located.

\*3 SEER and SCOP are based on 2009/125/EC: Energy-related Products Directive and Regulation (EU) No206/2012.

\*4 Joint pipe is required depending on installed refrigerant pipes, outdoor units and indoor units.

# SEZ SERIES



SEZ-M25-71DA(L)2



This concealed ceiling-mounted indoor unit series is compact, and fits easily into rooms with lowered ceilings. Highly reliable energy-saving performance makes it a best match choice for concealed unit installations.

## High Energy Efficiency



Highly efficient indoor units with DC inverter contribute to a reduction in electricity consumption throughout a year. The SEZ series has achieved energy-saving performance of "A+" or higher when connected to PUZ series and "A" or higher when connected to SUZ-M series.

### Power Inverter

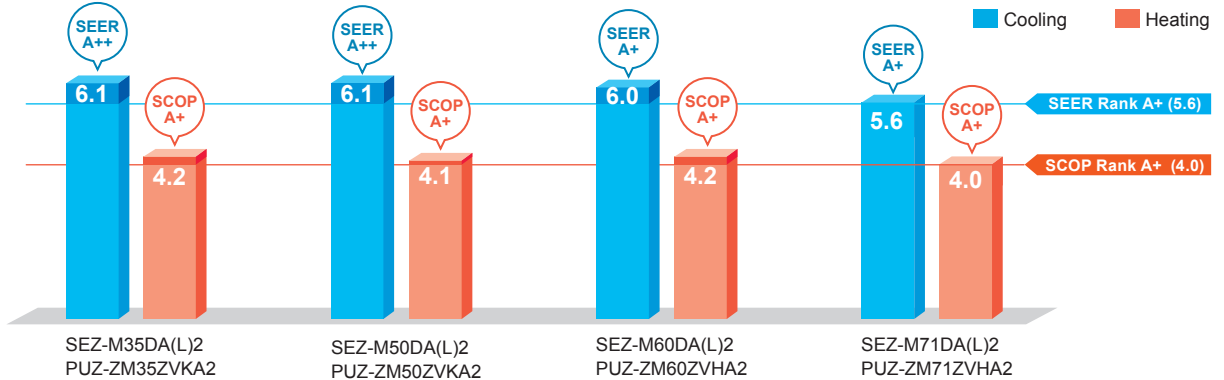

### Standard Inverter (R32)

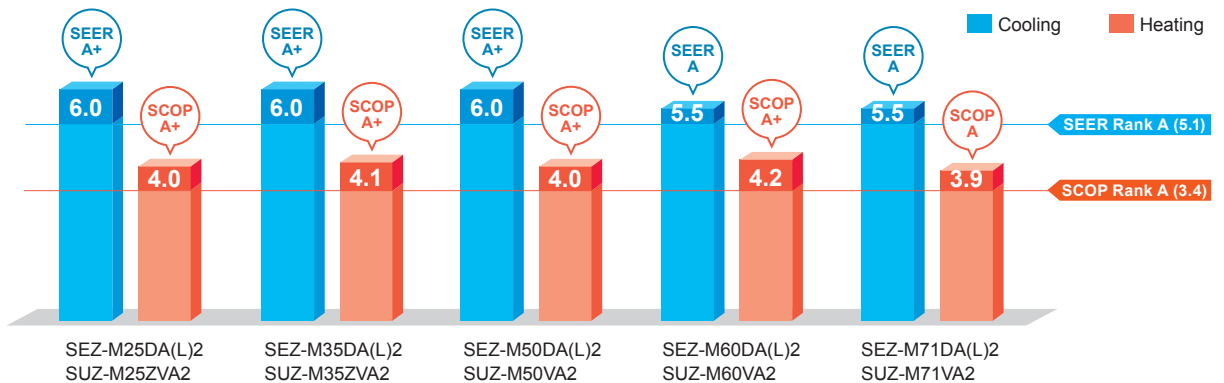

## Lineup of compatible outdoor unit has been expanded by power inverter series

Although models in the SEZ series were previously only compatible with the standard inverter, they can now also be connected to small capacity power inverters. The ability to connect to a power inverter with high-performance specifications makes it possible to offer an even wider range of solutions to our customers.

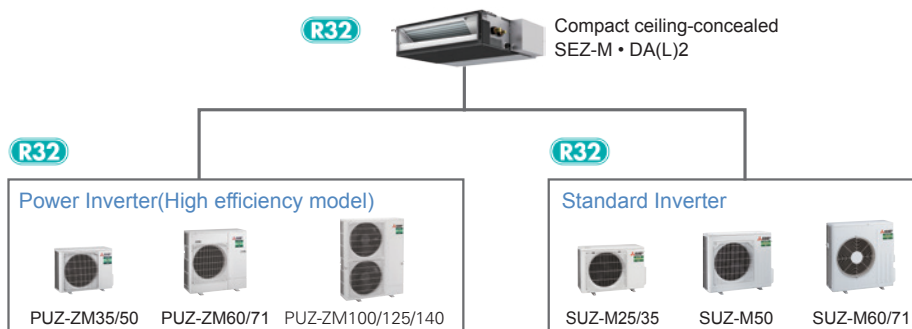

## Compact Design with a Height of 200 mm

The height of the units is 200 mm for all capacity ranges. Its thin body is suitable for installation in low ceilings with a small cavity space.

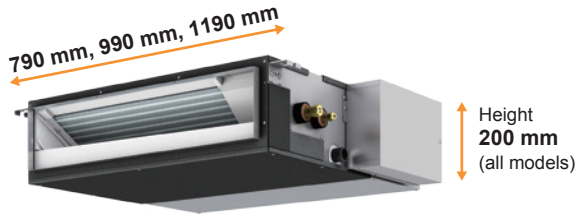

SEZ-M DA(L)2		M25	M35	M50	M60	M71
Height	mm	200				
Width	mm	790	990	1190		

## Low Noise Operation

Low noise operation contributes to a peaceful indoor environment. The SPL of M25/35 model, which is the quietest model among the new series, is as low as 22 dB (ESP 5 Pa, low fan speed setting).

Sound pressure level	Capacity		M25	M35	M50	M60	M71
	Fan speed	High	29	30	36	37	39
		Mid	25	26	33	33	34
	Low	22	22	29	29	29	

\*When fan speed setting is low, the cooling/heating capacity is subject to reduce.

\*Operation noise may increase due to the installation environment or the operation status.

## Selectable Static Pressure Levels

External static pressure can be selected from 5, 25, 35, and 50 Pa (set to 25 Pa at the time of factory shipment).

**Four levels Available for All Models**

## Drain Pump (Optional)

The PAC-KE07DM-E drain pump is available as an option. The drain connection can be raised as high as 580 mm, allowing more freedom in piping layout design.

\*The use of drain pump may increase the operation noise.

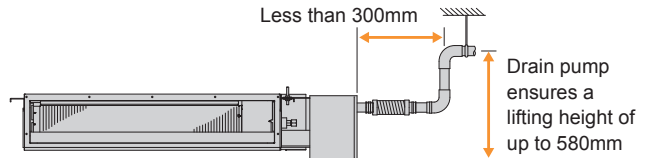

## Connectable to Plasma Quad Connect

The optional Plasma Quad Connect MAC-100FT-E can be installed on the indoor unit's air inlet side. For installation, PQ attachment PAC-HA11PAR is required.

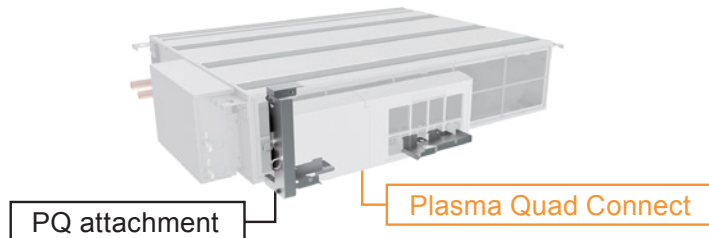



# SEZ-M SERIES



## Indoor Unit

R32  
R410A

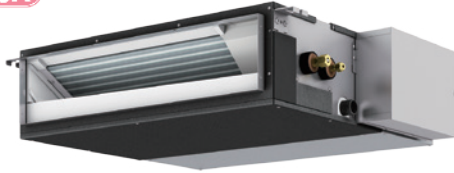

SEZ-M25/35/50/60/71DA2 (Requires Wired Remote Controller)  
SEZ-M25/35/50/60/71DAL2 (Wireless Remote Controller is enclosed)

## Outdoor Unit

R32 For Single

R32 For Multi (Twin/Triple/Quadruple)



PUZ-ZM35/50



PUZ-ZM60/71



PUZ-ZM71



PUZ-ZM100/125/140

## Remote Controller



Enclosed in SEZ-M DAL2



\*optional (for SEZ-M DA2)



\*optional (for SEZ-M DA2)



\*optional (for SEZ-M DA2)



Indoor Unit Combination	Outdoor Unit Capacity														
	For Single							For Twin			For Triple			For Quadruple	
	35	50	60	71	100	125	140	71	100	125	100	125	140	125	140
Power Inverter (PUZ-ZM)	35x1	50x1	60x1	71x1	-	-	-	35x2	50x2	60x2	35x3	50x3	50x3	35x4	35x4
Distribution Pipe	-	-	-	-	-	-	-	MSDD-50TR2-E			MSDT-111R3-E			MSDF-1111R2-E	

Type	Inverter Heat Pump																		
Indoor Unit	SEZ-M35DA(L)2			SEZ-M50DA(L)2			SEZ-M60DA(L)2			SEZ-M71DA(L)2									
Outdoor Unit	PUZ-ZM35VKA2			PUZ-ZM50VKA2			PUZ-ZM60VHA2			PUZ-ZM71VHA2									
Refrigerant <sup>(*)</sup>	R32																		
Power Supply	Outdoor power supply 230/Single/50																		
Cooling	Capacity		Rated	kW	3.6	5.0	6.1	7.1	Min-Max		kW	1.6 - 3.9	2.3 - 5.6	2.7 - 6.3	3.3 - 8.1				
	Total Input	Rated	kW	0.857	1.315	1.525	1.918	EER <sup>(4)</sup>	4.20	3.80	4.00	3.70	Design load	Rated	kW	3.6	5.0	6.1	7.1
Heating	Annual electricity consumption <sup>(2)</sup>		kWh/a	205	287	352	440	SEER <sup>(4)(5)</sup>	6.1	6.1	6.0	5.6	Capacity	Rated	kW	4.1	6.0	7.0	8.0
	Declared Capacity	at reference design temperature	kW	2.4 (-10°C)	3.8 (-10°C)	4.4 (-10°C)	4.7 (-10°C)	at bivalent temperature	kW	2.4 (-10°C)	3.8 (-10°C)	4.4 (-10°C)	4.7 (-10°C)	at operation limit temperature	kW	2.2 (-11°C)	3.7 (-11°C)	2.8 (-20°C)	3.5 (-20°C)
Operating Current(Max)	Annual electricity consumption <sup>(2)</sup>		kWh/a	791	1279	1464	1633	Back up heating capacity	Rated	kW	0.0	0.0	Energy efficiency class	A++	A++	A+	A+		
	SCOP <sup>(4)(5)</sup>	4.2	4.1	4.2	4.0														
Indoor Unit	Input [cooling / Heating]		Rated	kW	0.047	0.077	0.084	0.102	Operating Current(Max)	A <td>13.7</td> <td>13.8</td> <td>19.9</td> <td>20.0</td>	13.7	13.8	19.9	20.0					
	Operating Current(Max)	A <td>0.65</td> <td>0.82</td> <td>0.88</td> <td>1.00</td> <th>Dimensions</th> <th>[H*W*D]</th> <th>mm</th> <td>200 - 990 - 700</td> <td>200 - 990 - 700</td> <td>200 - 1190 - 700</td> <td>200 - 1190 - 700</td>	0.65	0.82	0.88	1.00	Dimensions	[H*W*D]	mm	200 - 990 - 700	200 - 990 - 700	200 - 1190 - 700	200 - 1190 - 700						
Outdoor Unit	Weight		kg	22	22	25.5	25.5	Air Volume	Cooling	m³/min	7 - 9 - 11	10 - 12.5 - 15	12 - 15 - 18	12 - 16 - 20					
	External Static Pressure <sup>(7)</sup>		Pa	<5> - 25 - <35> - <50>	<5> - 25 - <35> - <50>	<5> - 25 - <35> - <50>	<5> - 25 - <35> - <50>	Sound Level (Lo-Mid-Hi) (SPL)	Rated	dB(A)	23 - 27 - 31	30 - 34 - 37	30 - 34 - 38	30 - 35 - 40					
Ext. Piping	Sound Level (PWL)		5Pa <sup>(8)</sup>	dB(A)	22 - 26 - 30	29 - 33 - 36	29 - 33 - 37	29 - 34 - 39	Diameter <sup>(6)</sup>	Liquid/Gas	mm	6.35 / 12.7	6.35 / 12.7	9.52 / 15.88	9.52 / 15.88				
	Sound Level (PWL)		dB(A)	51	57	58	60	Max.Length	Out-In	m	50	50	55	55					
Guaranteed Operating Range (Outdoor)	Dimensions		[H*W*D]	mm	630-809-300	630-809-300	943-950-330(+25)	943-950-330(+25)	Max.Height	Out-In	m	30	30	30	30				
	Air Volume		Cooling	m³/min	45	45	55	55	Operating Current(Max)	A	13	13	19	19					
	Sound Level (SPL)		Cooling	dB(A)	44	44	47	47	Breaker Size	A	16	16	25	25					
	Sound Level (PWL)		Cooling	dB(A)	46	46	49	49	Guaranteed Operating Range (Indoor)	Cooling <sup>(3)</sup>	°C	-15 ~ +46	-15 ~ +46	-15 ~ +46	-15 ~ +46				
	Sound Level (PWL)		Heating	dB(A)	65	65	67	67	Heating	°C	-11 ~ +21	-11 ~ +21	-20 ~ +21	-20 ~ +21					

\*1 Refrigerant leakage contributes to climate change. Refrigerant with lower global warming potential (GWP) would contribute less to global warming than a refrigerant with higher GWP, if leaked to the atmosphere. This appliance contains a refrigerant fluid with a GWP equal to 550. This means that if 1 kg of this refrigerant fluid would be leaked to the atmosphere, the impact on global warming would be 550 times higher than 1 kg of CO<sub>2</sub> over a period of 100 years. Never try to interfere with the refrigerant circuit yourself or disassemble the product yourself and always ask a professional. The GWP of R32 is 675 in the IPCC 4th Assessment Report.

\*2 Energy consumption based on standard test results. Actual energy consumption will depend on how the appliance is used and where it is located.

\*3 Optional air protection guide is required where ambient temperature is lower than -5°C.

\*4 EER/COP and SEER/SCOP for M35-71 are measured at ESP 25Pa

\*5 SEER and SCOP are based on 2009/125/EC:Energy-related Products Directive and Regulation(EU) No206/2012.

\*6 Joint pipe is required depending on installed refrigerant pipes, outdoor units and indoor units.

\*7 The factory setting of ESP is shown without < >.

\*8 SPL measured at ESP 5Pa.

# SEZ-M SERIES



## Indoor Unit

R32  
R410A

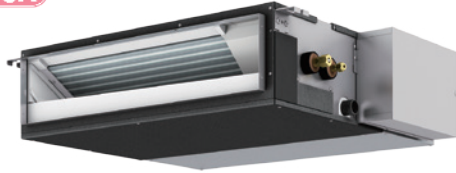

SEZ-M25/35/50/60/71DA2 (Requires Wired Remote Controller)  
SEZ-M25/35/50/60/71DAL2 (Wireless Remote Controller is enclosed)

## Outdoor Unit

For Single

R32



SUZ-M25/35VA

R32



SUZ-M50VA

R32



SUZ-M60/71VA

## Remote Controller



Enclosed in SEZ-M DAL2



\*optional (for SEZ-M DA2)



\*optional (for SEZ-M DA2)



\*optional (for SEZ-M DA2)



Indoor Unit Combination	Outdoor Unit Capacity				
	For Single				
	25	35	50	60	71
S Seires	25x1	35x1	50x1	60x1	71x1
Distribution Pipe	-	-	-	-	-

Type			Inverter Heat Pump					
Indoor Unit			SEZ-M25DA(L)2	SEZ-M35DA(L)2	SEZ-M50DA(L)2	SEZ-M60DA(L)2	SEZ-M71DA(L)2	
Outdoor Unit			SUZ-M25VA	SUZ-M35VA	SUZ-M50VA	SUZ-M60VA	SUZ-M71VA	
Refrigerant <sup>(*)</sup>			R32					
Power Supply	Source	Outdoor power supply						
Cooling	Outdoor(V/Phase/Hz)		230/Single/50					
	Capacity	Rated	kW	2.5	3.5	5.0	6.1	7.1
		Min-Max	kW	1.4 - 3.2	0.7 - 3.9	1.1 - 5.6	1.6 - 6.3	2.2 - 8.1
	Total Input	Rated	kW	0.714	1.000	1.547	1.848	2.151
	EER <sup>(4)</sup>			3.50	3.50	3.23	3.30	3.30
	Design load		kW	2.5	3.5	5.0	6.1	7.1
	Annual electricity consumption <sup>(2)</sup>		kWh/a	146	202	290	385	451
	SEER <sup>(4)(5)</sup>			6.0	6.0	6.0	5.5	5.5
	Energy efficiency class			A+	A+	A+	A	A
	Heating	Capacity	Rated	kW	2.9	4.2	6.0	7.4
Min-Max			kW	1.3 - 4.2	1.1 - 5.0	1.5 - 7.2	1.6 - 8.0	2.0 - 10.2
Total Input		Rated	kW	0.803	1.076	1.617	2.049	2.285
COP <sup>(4)</sup>				3.61	3.90	3.71	3.61	3.50
Design load			kW	2.2	2.6	4.3	4.6	5.8
Declared Capacity		at reference design temperature	kW	2.0 (-10°C)	2.3 (-10°C)	3.8 (-10°C)	4.1 (-10°C)	5.2 (-10°C)
		at bivalent temperature	kW	2.0 (-7°C)	2.3 (-7°C)	3.8 (-7°C)	4.1 (-7°C)	5.2 (-7°C)
		at operation limit temperature	kW	2.0 (-10°C)	2.3 (-10°C)	3.8 (-10°C)	4.1 (-10°C)	5.2 (-10°C)
Back up heating capacity			kW	0.2	0.3	0.5	0.6	0.6
Annual electricity consumption <sup>(2)</sup>			kWh/a	769	878	1501	1516	2030
SCOP <sup>(4)(5)</sup>			4.0	4.1	4.0	4.2	3.9	
Energy efficiency class			A+	A+	A+	A+	A	
Operating Current(Max)		A	7.4	9.2	14.3	15.7	15.8	
Indoor Unit	Input (cooling / Heating)	Rated	kW	0.043	0.047	0.077	0.084	0.102
	Operating Current(Max)		A	0.62	0.65	0.82	0.88	1.00
	Dimensions	H*W*D	mm	200 - 790 - 700	200 - 990 - 700	200 - 990 - 700	200 - 1190 - 700	200 - 1190 - 700
	Weight		kg	18	22	22	25.5	25.5
	Air Volume (Lo-Mid-Hi)		m <sup>3</sup> /min	5.5 - 7 - 9	7 - 9 - 11	10 - 12.5 - 15	12 - 15 - 18	12 - 16 - 20
	External Static Pressure <sup>(6)</sup>		Pa	<5> - 25 - <35> - <50>	<5> - 25 - <35> - <50>	<5> - 25 - <35> - <50>	<5> - 25 - <35> - <50>	<5> - 25 - <35> - <50>
	Sound Level (Lo-Mid-Hi) (SPL)	Rated	dB(A)	23 - 26 - 30	23 - 27 - 31	30 - 34 - 37	30 - 34 - 38	30 - 35 - 40
		5Pa <sup>(7)</sup>	dB(A)	22 - 25 - 29	22 - 26 - 30	29 - 33 - 36	29 - 33 - 37	29 - 34 - 39
	Sound Level (PWL)		dB(A)	50	51	57	58	60
	Outdoor Unit	Dimensions	H*W*D	mm	550-800-285	550-800-285	714-800-285	880-840-330
Weight			kg	30	35	41	54	55
Air Volume		Cooling	m <sup>3</sup> /min	36.3	34.3	45.8	50.1	50.1
		Heating	m <sup>3</sup> /min	34.6	32.7	43.7	50.1	50.1
Sound Level (SPL)		Cooling	dB(A)	45	48	48	49	49
		Heating	dB(A)	46	48	49	51	51
Sound Level (PWL)		Cooling	dB(A)	59	59	64	65	66
		Heating	dB(A)	6.8	8.5	13.5	14.8	14.8
Operating Current(Max)			A	6.8	8.5	13.5	14.8	14.8
Breaker Size			A	10	10	20	20	20
Ext.Piping	Diameter <sup>(8)</sup>	Liquid/Gas	mm	6.35 / 9.52	6.35 / 9.52	6.35 / 12.7	6.35 / 15.88	9.52 / 15.88
	Max.Length	Out-In	m	20	20	30	30	30
	Max.Height	Out-In	m	12	12	30	30	30
Guaranteed Operating Range (Outdoor)	Cooling <sup>(9)</sup>	°C	-10 ~ +46	-10 ~ +46	-15 ~ +46	-15 ~ +46	-15 ~ +46	
	Heating	°C	-10 ~ +24	-10 ~ +24	-10 ~ +24	-10 ~ +24	-10 ~ +24	

\*1 Refrigerant leakage contributes to climate change. Refrigerant with lower global warming potential (GWP) would contribute less to global warming than a refrigerant with higher GWP if leaked to the atmosphere. This appliance contains a refrigerant fluid with a GWP equal to 1975. This means that if 1 kg of this refrigerant fluid would be leaked to the atmosphere, the impact on global warming would be 1975 times higher than 1 kg of CO<sub>2</sub>, over a period of 100 years. Never try to interfere with the refrigerant circuit yourself or disassemble the product yourself and always ask a professional.

The GWP of R410A is 2088 in the IPCC 4th Assessment Report.

\*2 Energy consumption based on standard test results. Actual energy consumption will depend on how the appliance is used and where it is located.

\*3 SEER/SCOP are measured at ESP 25Pa.

\*4 SEER and SCOP are based on 2009/125/EC:Energy-related Products Directive and Regulation(EU) No206/2012.

\*5 Joint pipe is required depending on installed refrigerant pipes, outdoor units and indoor units.

\*6 The factory setting of ESP is shown without < > .

\*7 SPL measured at ESP 5Pa.

# SFZ SERIES

The concealed floor standing type indoor unit is newly introduced to the S-series and can be neatly installed in the perimeter zone. High energy efficiency is achieved across all capacity range. External static pressure, airflow rate, and air intake direction can be selected according to the customer's choice.

R32

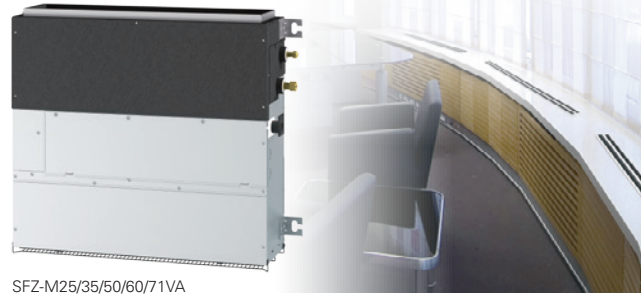

SFZ-M25/35/50/60/71VA

## A wide lineup offering high energy efficiency

The SFZ series achieves an A++ rating on the SEER index, and an A+ rating on the SCOP index for all capacity range. No matter which capacity you select, the series offers a high level of energy efficiency.

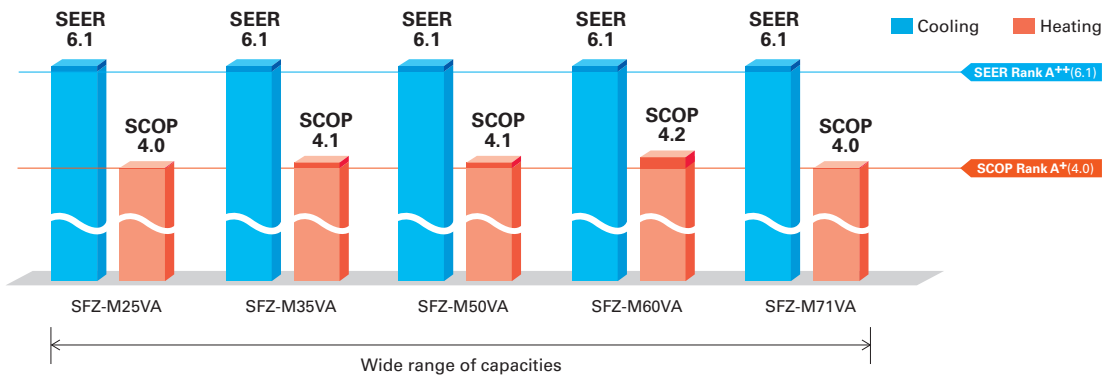

## Compact body and small footprint

With the control box built inside the unit, the compact body and small footprint are realized. This allows the unit to be installed within a small perimeter zone.

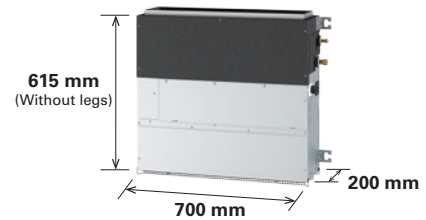

## Flexible installation

Air inlet direction from the bottom or front can be selected by changing panel, fan guard and filter.

### Bottom suction \*1

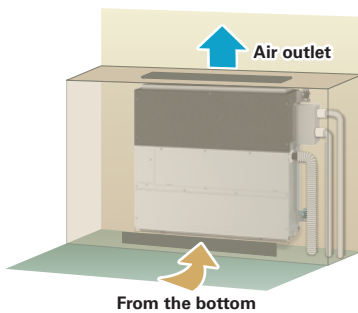

### Front suction \*2

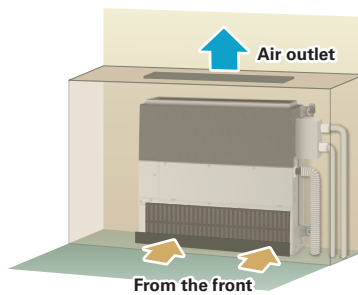

### Installation with legs

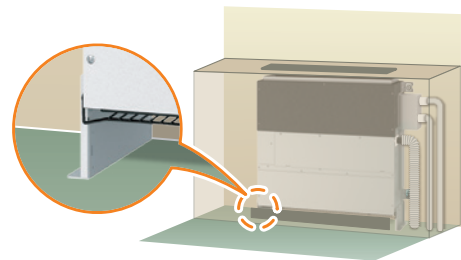

\*Height of unit (with legs) is 690 mm.  
\*Legs are supplied as accessory with the unit.

\*1 Select a site where the flow of supply air is not blocked. The unit cannot be placed directly on the floor in the case of bottom suction.

\*2 Unit with front suction generate more noise compared to bottom suction. Not recommended to be installed in rooms such as bedrooms where quietness is valued.

## Fan speed

Airflow rate can be selected from 3 patterns; Low-Medium-High.

## External static pressure

Four levels of static pressure are available. The ability to select additional static pressure provides flexibility for air outlet configuration.

SFZ-M25/35/50/60/71VA <0>/25/<40>/<60> Pa

The factory setting of external static pressure is shown without brackets (<>).

Refer to "Fan characteristics curves" according to the external static pressure, in the DATA BOOK for the usable range of airflow rate.

# SFZ-M SERIES

## Indoor Unit

R32



SFZ-M25/35/50/60/71VA

## Outdoor Unit

R32

R32

R32



SUZ-M25/35VA



SUZ-M50VA



SUZ-M60/71VA

## Remote Controller



PAR-40MAA  
\*Optional



PAR-CT01MAA  
\*Optional



PAC-YT52CRA  
\*Optional

Type			Inverter Heat Pump						
Indoor Unit			SFZ-M25VA	SFZ-M35VA	SFZ-M50VA	SFZ-M60VA	SFZ-M71VA		
Outdoor Unit			SUZ-M25VA	SUZ-M35VA	SUZ-M50VA	SUZ-M60VA	SUZ-M71VA		
Refrigerant*1			R32*1						
Power Supply	Source		Outdoor power supply						
	Outdoor (V/Phase/Hz)		230 / Single / 50						
Cooling	Capacity	Rated	kW	2.5	3.5	5.0	6.1	7.1	
		Min - Max	kW	1.5 - 3.2	0.7 - 3.9	1.1 - 5.6	1.6 - 6.3	1.9 - 8.1	
	Total Input	Rated	kW	0.641	1.000	1.470	1.848	2.151	
	EER			3.90	3.50	3.40	3.30	3.30	
	Design Load		kW	2.5	3.5	5.0	6.1	7.1	
	Annual Electricity Consumption*2		kWh/a	143	199	284	346	403	
	SEER*4*5			6.1	6.1	6.1	6.1	6.1	
	Energy Efficiency Class			A++	A++	A++	A++	A++	
	Heating (Average Season)	Capacity	Rated	kW	3.2	4.1	6.0	7.0	8.0
			Min - Max	kW	1.2 - 4.2	1.0 - 5.0	1.5 - 7.2	1.6 - 8.0	2.0 - 10.2
Total Input		Rated	kW	0.886	1.051	1.617	1.886	2.156	
COP				3.61	3.90	3.71	3.71	3.71	
Design Load			kW	2.2	2.6	4.3	4.6	5.8	
Declared Capacity		at reference design temperature	kW	2.0 (-10°C)	2.3 (-10°C)	3.3 (-10°C)	4.1 (-10°C)	5.2 (-10°C)	
		at bivalent temperature	kW	2.0 (-7°C)	2.3 (-7°C)	3.8 (-7°C)	4.1 (-7°C)	5.2 (-7°C)	
		at operation limit temperature	kW	2.0 (-10°C)	2.3 (-10°C)	3.3 (-10°C)	4.1 (-10°C)	5.2 (-10°C)	
Back Up Heating Capacity			kW	0.2	0.3	1.0	0.5	0.6	
Annual Electricity Consumption*2			kWh/a	766	887	1467	1532	1997	
SCOP*4*5			4.0	4.1	4.1	4.2	4.0		
Energy Efficiency Class			A+	A+	A+	A+	A+		
Operating Current (max)			A	7.2	8.9	14.1	15.4	15.6	
Indoor Unit	Input	Rated	kW	0.041	0.044	0.072	0.078	0.095	
		Operating Current (max)	A	0.44	0.44	0.61	0.64	0.76	
	Dimensions <Panel>*6*7	H x W x D	mm	615 (690) - 797 (700) - 200	615 (690) - 997 (900) - 200	615 (690) - 997 (900) - 200	615 (690) - 1197 (1100) - 200	615 (690) - 1197 (1100) - 200	
	Weight <Panel>		kg	18.5	22.5	22.5	25.5	25.5	
	Air Volume [Lo-Mid-Hi]		m <sup>3</sup> /min	5.5 - 7 - 9	7 - 9 - 11	10 - 12.5 - 15	12 - 15 - 18	12 - 16 - 20	
	External Static Pressure*8		Pa	<0> / 25 / <40> / <60>	<0> / 25 / <40> / <60>	<0> / 25 / <40> / <60>	<0> / 25 / <40> / <60>	<0> / 25 / <40> / <60>	
	Sound Level (SPL)*9 [Lo-Mid-Hi]		dB(A)	25 - 29 - 35	25 - 29 - 33	30 - 35 - 39	30 - 35 - 39	30 - 36 - 42	
	Sound Level (PWL)		dB(A)	54	53	59	59	61	
	Outdoor Unit	Dimensions	H x W x D	mm	550 - 800 - 285	550 - 800 - 285	714 - 800 - 285	880 - 840 - 330	880 - 840 - 330
			Weight	kg	30	35	41	54	55
Air Volume		Cooling	m <sup>3</sup> /min	36.3	34.3	45.8	50.1	50.1	
		Heating	m <sup>3</sup> /min	34.6	32.7	43.7	50.1	50.1	
Sound Level (SPL)		Cooling	dB(A)	45	48	48	49	49	
		Heating	dB(A)	46	48	49	51	51	
Sound Level (PWL)		Cooling	dB(A)	59	59	64	65	66	
Operating Current (max)			A	6.8	8.5	13.5	14.8	14.8	
Breaker Size			A	10	10	20	20	20	
Ext. Piping		Diameter	Liquid / Gas	mm	6.35 / 9.52	6.35 / 9.52	6.35 / 12.7	6.35 / 15.88	9.52 / 15.88
	Max. Length	Out-In	m	20	20	30	30	30	
	Max. Height	Out-In	m	12	12	30	30	30	
Guaranteed Operating Range [Outdoor]	Cooling*3	°C	-10 ~ +46	-10 ~ +46	-15 ~ +46	-15 ~ +46	-15 ~ +46		
	Heating	°C	-10 ~ +24	-10 ~ +24	-10 ~ +24	-10 ~ +24	-10 ~ +24		

\*1 Refrigerant leakage contributes to climate change. Refrigerant with lower global warming potential (GWP) would contribute less to global warming than a refrigerant with higher GWP, if leaked to the atmosphere. This appliance contains a refrigerant fluid with a GWP equal to 1975. This means that if 1 kg of this refrigerant fluid would be leaked to the atmosphere, the impact on global warming would be 1975 times higher than 1 kg of CO<sub>2</sub> over a period of 100 years. Never try to interfere with the refrigerant circuit yourself or disassemble the product yourself and always ask a professional.

The GWP of R410A is 2088 in the IPCC 4th Assessment Report.

\*2 Energy consumption based on standard test results. Actual energy consumption will depend on how the appliance is used and where it is located.

\*3 SEER/SCOP are measured at ESP 25Pa.

\*4 SEER and SCOP are based on 2009/125/EC:Energy-related Products Directive and Regulation(EU) No206/2012.

\*5 Joint pipe is required depending on installed refrigerant pipes, outdoor units and indoor units.

\*6 The height that includes the duct flange is 638 (713) mm. The values in ( ) show the height of unit with leg.

\*7 The width includes the pipe cover (sheet metal). The values in ( ) show the width that does not include the pipe cover.

\*8 The factory setting of ESP is shown without < >.

\*9 SPL measured at ESP 25Pa.

# CONTROL TECHNOLOGIES

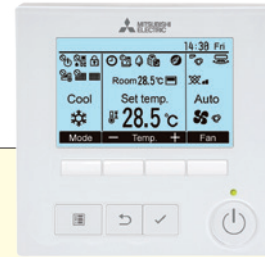

PAR-41MAA

**User-friendly Deluxe Remote Controller with Excellent Operability and Visibility**

## 2+1 Back-up rotation\*

The use of a three-refrigerant air conditioning system enables you to utilize the back-up, rotation, and cut-in functions. This allows you to implement effective risk management for added peace of mind.

\*Availability of this function is depending on outdoor unit, indoor unit and remote controller.

### Back-up Function

In the unlikely event that one of the units stops operation due to an abnormality, the standby unit immediately starts back-up operation. Being fully prepared for a failure guarantees that an operation is always available and gives you the confidence that your system will be reliable in any situation.

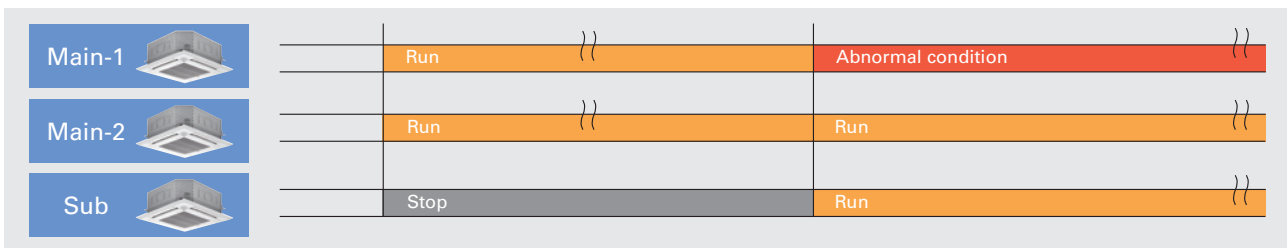

### Rotation Function

A single remote controller is used to operate three-refrigerant air conditioning system in a rotation pattern. Reducing the burden on the equipment allows you to maintain a longer time between maintenance and increases product life.



### Cut-in Function

If the actual room temperature greatly differs from the set temperature and two-refrigerant air conditioning system is insufficient, the standby unit starts operation to provide support.

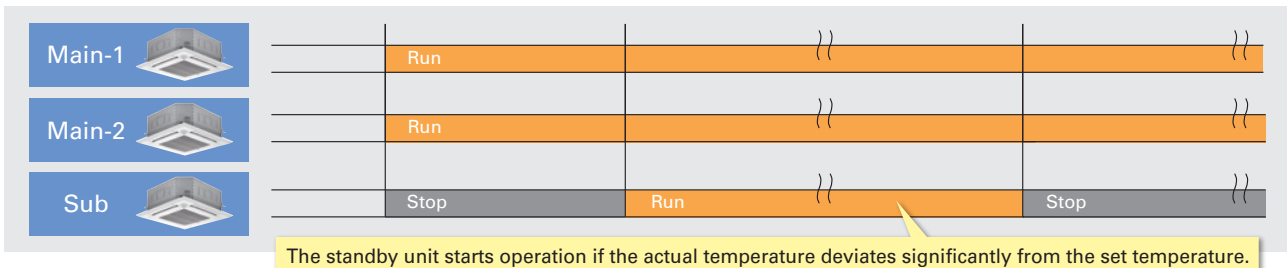















# P

SERIES



# SELECTION



Line-up includes a selection of eight indoor units and four series of outdoor units.  
Easily construct a system that best matches room air conditioning needs.

R32 R410A INDOOR UNIT		R32 OUTDOOR UNIT	
 4-way ceiling-cassette PLA-ZM EA PLA-M EA	 Wall-mounted PKA-M LA (L) PKA-M KA (L)	<b>Power Inverter</b>  PUZ-ZM35/50  PUZ-ZM60/71  PUZ-ZM100/125/140/ 200/250	<b>Standard Inverter</b>  SUZ-M35  SUZ-M50  SUZ-M60/71  PUZ-M100/125/140  PUZ-M200/250
 Ceiling-concealed PEAD-M	 Ceiling-concealed PEA-M		
 Ceiling-suspended PCA-M	 Floor-standing PSA-M		
 Professional Kitchen PCA-M HA			

\* Some indoor units cannot be used with this unit.

## SELECT COMBINATION

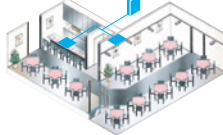
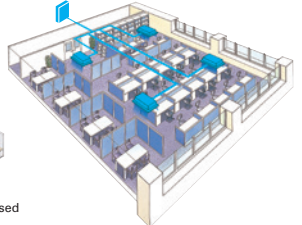
Choose the installation pattern for the indoor units. (In the case of a multi-system, distribution piping is necessary, so please select the necessary piping as well.)

<b>Single System</b> 	<b>Simultaneous Multi-System</b> <b>Twin</b> Allows simultaneous operation of two indoor units on one floor. 	<b>Quadruple</b> Realises the optimum temperature distribution even in a large space. 
	<b>Triple</b> Can cover a large-scale space or dispersed installation on the same floor. 	

### Connectable Combinations for Inverter Units

Outdoor Unit Capacity	Indoor Unit Capacity		
	Twin	Triple	Quadruple
71	50 : 50 35 × 2	33 : 33 : 33 —	25 : 25 : 25 : 25 —
100	50 × 2	—	—
125	60 × 2	—	—
140	71 × 2	50 × 3	—
200	100 × 2	60 × 3	50 × 4
250	125 × 2	71 × 3	60 × 4
Distribution Pipe	MSDD-50TR-E MSDD-50WR-E MSDD-50TR2-E2 MSDD-50WR2-E	MSDT-111R-E MSDT-111R3-E	MSDF-1111R-E MSDF-1111R2-E

Note: The distribution pipe listed is required for simultaneous multi-systems.

# Power Inverter SERIES

Our Eco-conscious Power Inverter Series is designed to achieve industry-leading seasonal energy-efficiency through use of New R32 refrigerant and advanced technologies.

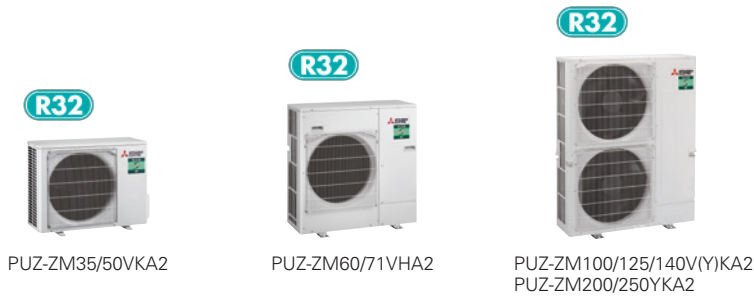

## Industry-leading energy efficiency

Introduction of R32 refrigerant realises improved cooling efficiency. Rating of more than 7.0 achieved for all capacity range.

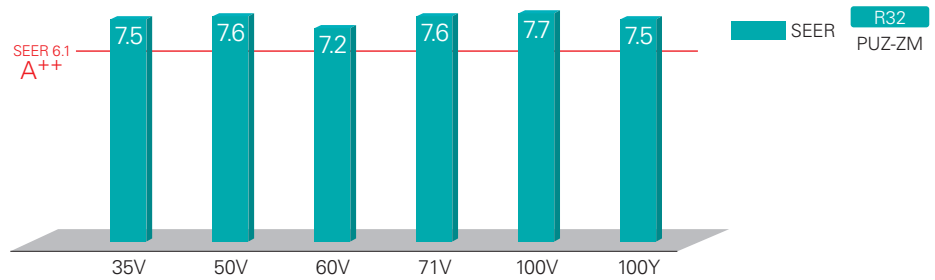

Introduction of R32 refrigerant reduces energy consumption and realises energy savings.

## Longer piping (60/71/100/125/140/200/250)

Longer piping length realised for 60, 71, 100, 125, 140, 200 and 250 classes, widely increasing installation flexibility.

	Piping Length
	R32 PUZ-ZM
35/50	50m
60/71	55m
100/125/140	100m
200/250	100m

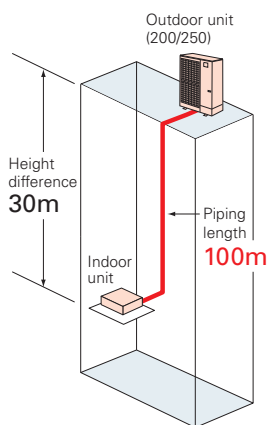

## Rated heating capacity maintained down to $-3^{\circ}\text{C}^*$

Rated heating capacity maintained even when the outside temperature is down to  $-3^{\circ}\text{C}$ . Stay warm even at times of cold weather.

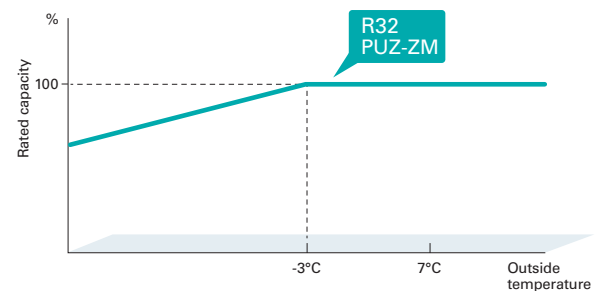

\*PUZ-ZM35/50/60/71/100/125/140 only.



## 2+1 Back-up rotation\*

The use of a three-refrigerant air conditioning system enables you to utilize the back-up, rotation, and cut-in functions. This allows you to implement effective risk management for added peace of mind.

\*Availability of this function is depending on outdoor unit, indoor unit and remote controller.

### Back-up Function

In the unlikely event that one of the units stops operation due to an abnormality, the standby unit immediately starts back-up operation. Being fully prepared for a failure guarantees that and operation is always available and gives you the confidence that your system will be reliable in any situation.

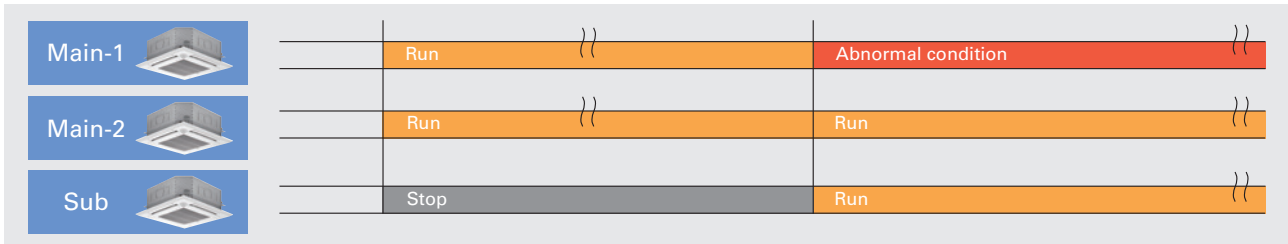

### Rotation Function

A single remote controller is used to operate three-refrigerant air conditioning system in a rotation pattern. Reducing the burden on the equipment allows you to maintain a longer time between maintenance and increases product life.



### Cut-in Function

If the actual room temperature greatly differs from the set temperature and two-refrigerant air conditioning system is insufficient, the standby unit starts operation to provide support.

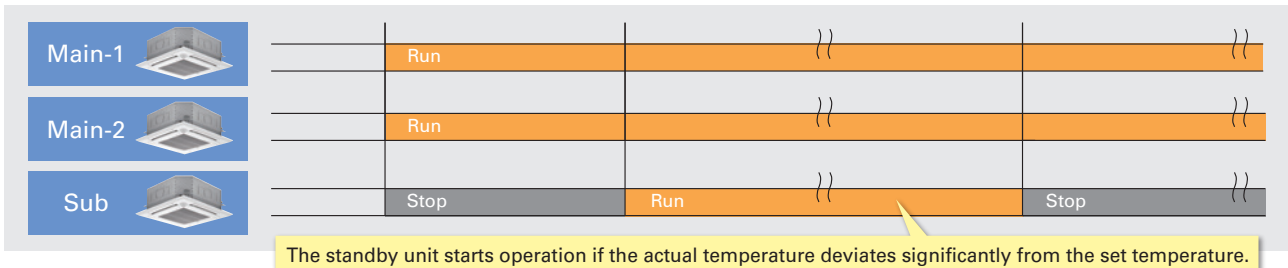

## Extended cooling set temperature range\*

In environments such as gyms where people do strenuous exercise, even if the room is cooled to an appropriate temperature, people may feel that it is hot, and they need a cooler air. To satisfy such demands, we have extended the lower limit of the cooling set temperature range from 19–30°C. to 14–30°C.

\*Insulation kit (PAC-SK36HK-E) is required when indoor unit is PLA series.

\*Availability of this function is depending on outdoor unit, indoor unit and remote controller.

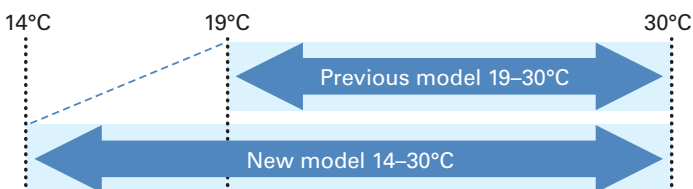

## Display of model names and serial numbers\*

The model names and serial numbers of the indoor/outdoor units that are connected to the MA smart remote controller can be automatically acquired and displayed through one simple operation. This eliminates the need to directly check each unit and helps with inquiries in the case of an abnormality.

\*Availability of this function is depending on outdoor unit, indoor unit and remote controller.

### ● Model name display (example)

```
Collect model names and S/N
OU PUZ-ZM200YKA2
IU1 PLA-ZM50EA2
IU2 PLA-ZM50EA2
IU3 PLA-ZM50EA2
IU4 PLA-ZM50EA2
Collect data: ✓
-Address + S/N
```

### ● Serial number display (example)

```
Collect model names and S/N
OU 1ZU0001
IU1 1ZA0001
IU2 1ZA0002
IU3 1ZA0003
IU4 1ZA0004
Collect data: ✓
-Address + Model
```

## Preliminary error history\*

In addition to error history, the history of preliminary abnormalities can be displayed. The feature enables the unit status check during inspection and maintenance.

\*Availability of this function is depending on outdoor unit, indoor unit and remote controller.

### ●Error history (Sample)

Error history		1/4
Error	Unt# dd/mm/yy	
E0	0-1 21/10/20 PM12:34	
E0	0-1 20/12/20 AM 1:23	
E0	0-1 20/11/20 PM10:55	
E0	0-1 20/10/20 PM12:01	
Error history menu: ↻		
▼ Page ▲	Delete	

### ●Preliminary error history (Sample)

Preliminary error hist.		1/8
Error	Unt# dd/mm/yy	
E0	0-1 21/10/20 PM12:34	
E0	0-1 20/12/20 AM 1:23	
E0	0-1 20/11/20 PM10:55	
E0	0-1 20/10/20 PM12:01	
Error history menu: ↻		
▼ Page ▲	Delete	

## Display of power consumption\*

It is possible to measure, acquire, and display the amount of energy used by each air conditioning system.

\*Availability of this function is depending on outdoor unit, indoor unit and remote controller.

< Data Collection Period >

Time data: Every 30 minutes over the past month

Monthly/daily data: Monthly over the past 14 months

Energy consumption values are calculated from estimated power consumption values according to the operating conditions. They may vary from the actual power consumption values. Please note that the power consumption of optional parts is not included except in the case of optional parts that have their power supplied directly by the outdoor unit.

### ●Every 30 minutes (example)

Energy data	
2019- 1- 1	1234.5kWh 1/6
0:30 123.4kWh	2:30 123.4kWh
1:00 123.4kWh	3:00 123.4kWh
1:30 123.4kWh	3:30 123.4kWh
2:00 123.4kWh	4:00 123.4kWh
Return: ↻	
- Date +	▼ Page ▲

### ●Daily (example)

Energy data	
2019- 1	123456.7kWh 1/4
31 1234.5kWh	27 1234.5kWh
30 1234.5kWh	26 1234.5kWh
29 1234.5kWh	25 1234.5kWh
28 1234.5kWh	24 1234.5kWh
Return: ↻	
▼ Page ▲	

### ●Monthly (example)

Energy data	
▶2019- 1	123456.7kWh 1/3
2018-12	123456.7kWh
2018-11	123456.7kWh
2018-10	123456.7kWh
2018- 9	123456.7kWh
View daily data: ✓	
▼ Cursor ▲	

## Improved defrosting performance\*

\*Availability of this function is depending on outdoor unit, indoor unit and remote controller.

### Avoiding Simultaneous Defrosting

When each of multiple units is in operation for heating in the same space, these may start defrosting at the same time, resulting in a drop in the room temperature. Therefore, we have developed a new function that controls up to four-refrigerant air conditioning system to avoid simultaneous defrosting. By ensuring that defrosting is only performed by one unit at a time, it is possible to minimize any decrease in room temperature.

#### Example System Configuration

Four sets controlled by a single remote controller

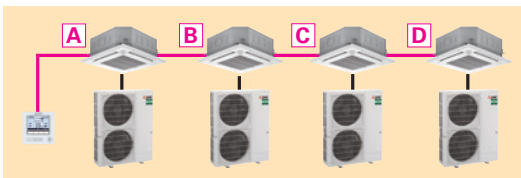

#### ■When All Sets Are Controlled Together

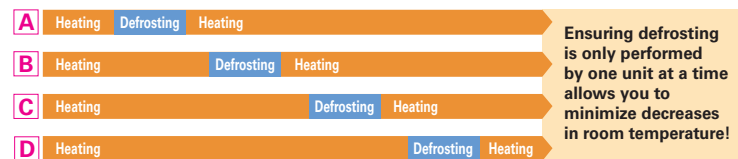

### Defrosting When People Are Absent

The use of the 3D i-see sensor allows a more comfortable defrosting schedule. After a large amount of frost has built up, the system will switch to defrosting when the 3D i-see sensor detects that no people are present. By minimizing defrosting while people are in the room, there is a much lower chance of a temperature drop while the room is occupied.

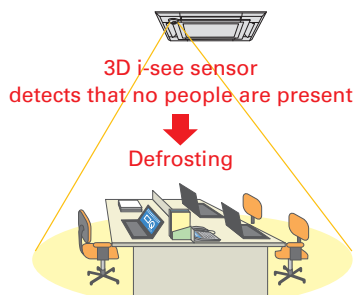

\* Only compatible with 4-way cassette and 2x2 cassette models with an attached 3D i-see sensor panel. Even though people are present in the room, the defrosting process may start if all defrosting conditions are met.

### Defrosting When Operation is Stopped

It takes a long time to start operation if there is an excess build-up of frost. Therefore, each unit is equipped with a control system where defrosting is performed immediately after operation is stopped when there is a large amount of frost. This allows heating to be quickly started the next day.

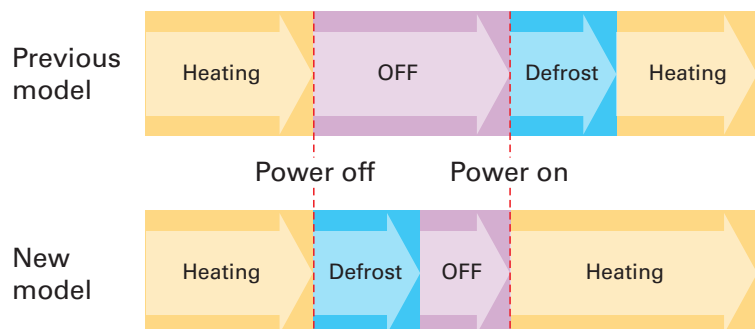

The power turns off after defrosting is complete and the system will start up smoothly the next time it is used.

## Easier M-NET Adapter Installation

The optional M-NET adapter, which allows centralized control (M-NET control), is now easier to install. The redesigned mounting position significantly reduces the time and effort for installation.

### Conventional Model

PAC-SJ96MA-E

Removed parts

The (1) top panel, (2) front panel, (3) service panel, and (4) electronics box need to be removed, and the connector must be temporarily unplugged.

### M-NET adapter mounting position

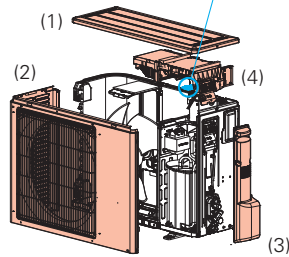

### New Model

PAC-SK15MA-E

Removed parts

There is no need to remove the (1) top panel, (2) service panel, (3) service plate, electronics box, nor temporarily unplug the connector.

### M-NET adapter mounting position

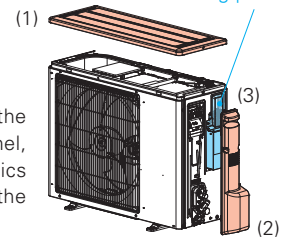

## Improved chargeless piping length ZM100/125/140

PUZ-ZM100/125/140V(Y)KA used to have a chargeless pipe length of 30 m. However, starting with the V(Y)KA2 model, this has been extended to 40 m. This allows it to be used for a wider range of applications without the need for additional charging of refrigerant.

	Maximum piping length	Chargeless piping length			Maximum piping length	Chargeless piping length
PUZ-ZM 100V (Y)KA	100m	30m	→	PUZ-ZM 100V (Y)KA2	100m	40m
PUZ-ZM 125V (Y)KA	100m	30m	→	PUZ-ZM 125V (Y)KA2	100m	40m
PUZ-ZM 140V (Y)KA	100m	30m	→	PUZ-ZM 140V (Y)KA2	100m	40m

## Utilizing IoT for Improved Convenience\*

\*Availability of IoT functions are depending on MELCloud version.

By connecting to a MAC-587IF-E Wi-Fi interface, it is possible to collect data and perform air conditioning control via MELCloud. In addition to basic functions such as turning the power on/off and setting the temperature, it is also possible to acquire data used for maintenance and inspection such as model names, serial numbers, and operation data.

### [Basic Operation Functions]

- Operation on/off
- Temperature setting
- Operation mode
- Airflow speed
- Airflow direction etc...

### [Data Collection and Display]

- Model name display
- Serial number display
- Collection of operation data
- Energy consumption display etc...

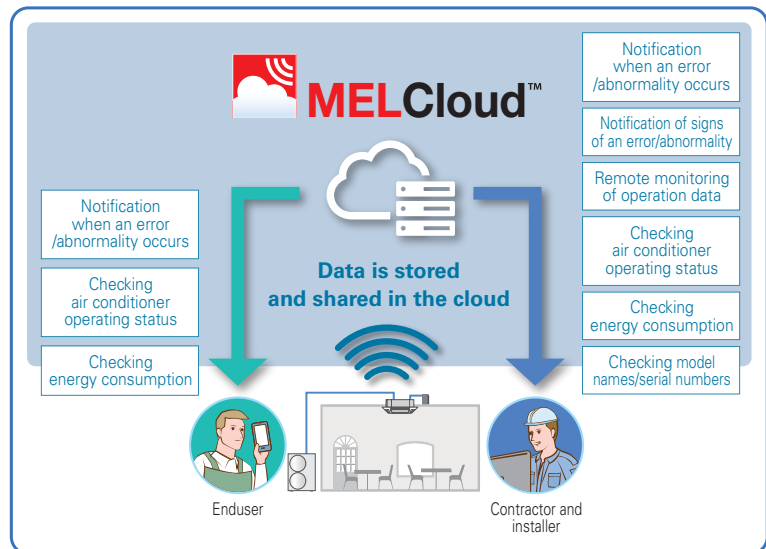

## MELCloud System Configuration

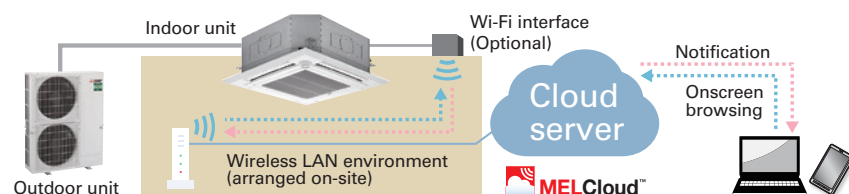

## Wi-Fi Adapter (Optional) Installation

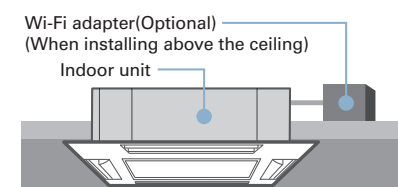

## On-Site Installation and Configuration

### ① Wireless LAN adapter installation

Connect the wireless LAN adapter to the indoor unit PCB and install it above the ceiling.

### ② Wireless LAN adapter and router connection settings

### ③ Wireless LAN adapter and server connection settings

## Collection of operation data

All the operation data required for maintenance and inspection can be collected in a simple step. This data can then be easily checked via MELcloud. This makes it easy to check the operating status data even in cases when it is difficult to do a visual inspection. This allows you to quickly identify any system malfunctions. This function also helps to improve the quality of installation work and shortening the time required for maintenance and inspection.

### Operation data that can be collected (example)

- Compressor frequency ●Compressor operating current ●Outdoor discharge temperature
- Outdoor heat exchanger temperature ●Outdoor air temperature ●Compressor shell temperature
- Sub cool ●Discharge superheat ●Indoor inlet temperature ●Indoor heat exchanger temperature
- Total compressor operating time●Compressor operation count ●Indoor filter operating time

This operation data is strange...



\*1 The total compressor operating time is displayed in units of 10 hours. The compressor operation count is displayed in units of 100.  
\*2 Indicates the elapsed time since a filter sign reset was performed.

## Demand control

It is possible to control air-conditioners to appropriately operate according to the energy supply-demand adjustment by electric power companies and each electricity rate plan of end users.

e.g. <Peak cut control> It is possible to utilize an external demand signal to reduce power consumption during peak hours. By satisfying the need for reducing peak power consumption or shifting consumption to a non-peak period, we have increased the range of options for our customers.

## Notification of potential abnormality

The comprehensive analysis of operating data allows the early detection of abnormalities in small functional parts by alerting the operator of any signs of abnormal behaviour. The recognition in advance of abnormalities in each unit further improves the ease of servicing and maintenance. Since this allows a countermeasure to be implemented before the abnormality requires the unit to be completely shut down, it is an effective method for maintaining the unit in its optimum condition.

### [Abnormalities That Have Their Signs Monitored]

- Filter blockage ●Drain blockage ●Refrigerant leakage
- Heat exchanger blockage etc...

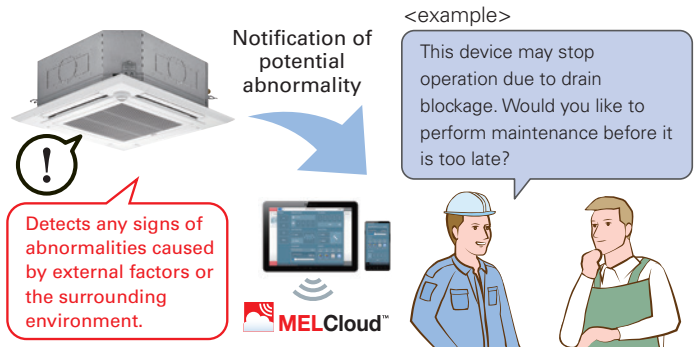

# Standard Inverter SERIES

Our Standard Series become light and compact with greater energy-saving performance.

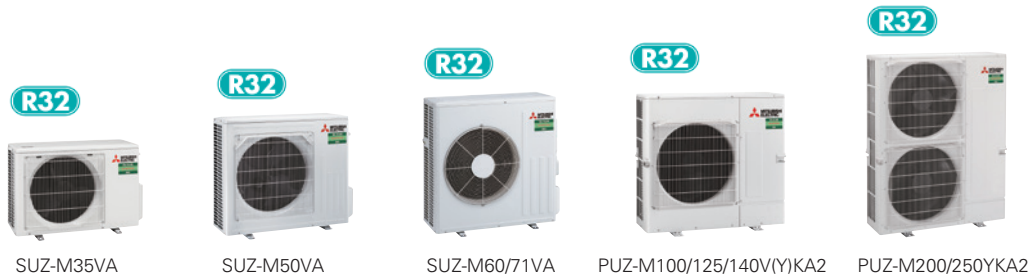

## Improved energy efficiency

Introduction of new R32 refrigerant realizes improved cooling efficiency. Rating of more than 6.6 achieved for all capacity range.

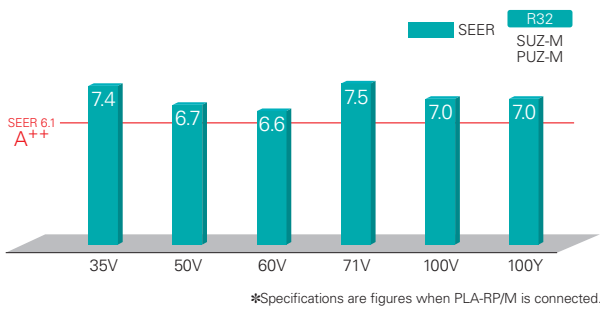

## Longer piping (100/125/140/200/250)



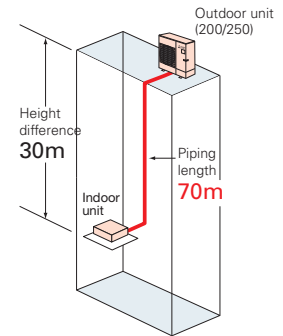

Longer piping length realized for 100, 125, 140, 200 and 250 classes, widely increasing installation flexibility.

	Max. Piping Length
	R32 SUZ-M PUZ-M
25/35	20m
50/60/71	30m
100	55m
125/140	65m
200/250	70m



## Light weight and compact size

Compact design fits into narrow outdoor unit space of condominiums and offices. Light weight design facilitates easy installation.

	<p><b>SUZ-KA50VA6</b></p> <p>Height 880mm</p> <p>Weight 54kg</p>	➔		<p><b>SUZ-M50VA</b></p> <p>Height 714mm <b>18% reduction</b></p> <p>Weight 41kg <b>24% reduction</b></p>
	<p><b>PUHZ-P140YHA2</b></p> <p>Height 1,350mm</p> <p>Weight 101kg</p>	➔		<p><b>PUZ-M140YKA2</b></p> <p>Height 981mm <b>27% reduction</b></p> <p>Weight 85kg <b>15% reduction</b></p>

### Unobstructive, compact, and easy to hide from view

Conventional outdoor units may spoil the view. Due to its compact size, the new model can be installed in locations that previous model is not suitable.

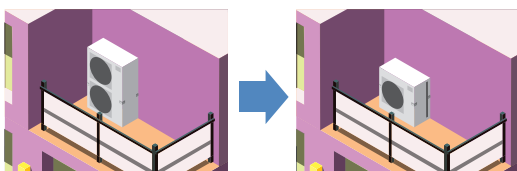

### Easy transportation and installation

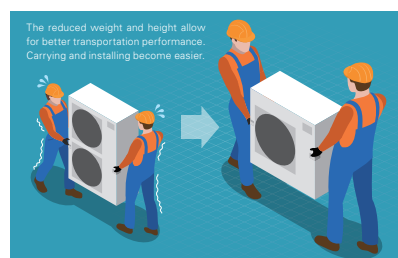

Transport efficiency improves thanks to its low height. The unit can even be transported by minivan.

## 2+1 Back-up rotation\*

The use of a three-refrigerant air conditioning system enables you to utilize the back-up, rotation, and cut-in functions. This allows you to implement effective risk management for added peace of mind.

\*Availability of this function is depending on outdoor unit, indoor unit and remote controller.

### Back-up Function

In the unlikely event that one of the units stops operation due to an abnormality, the standby unit immediately starts back-up operation. Being fully prepared for a failure guarantees that and operation is always available and gives you the confidence that your system will be reliable in any situation.

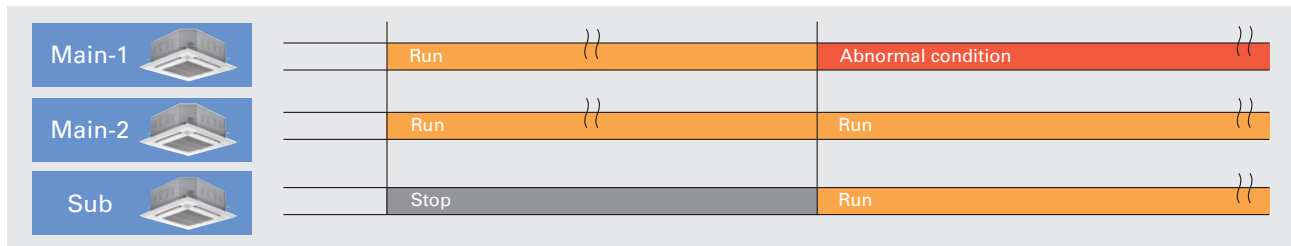

### Rotation Function

A single remote controller is used to operate three-refrigerant air conditioning system in a rotation pattern. Reducing the burden on the equipment allows you to maintain a longer time between maintenance and increases product life.

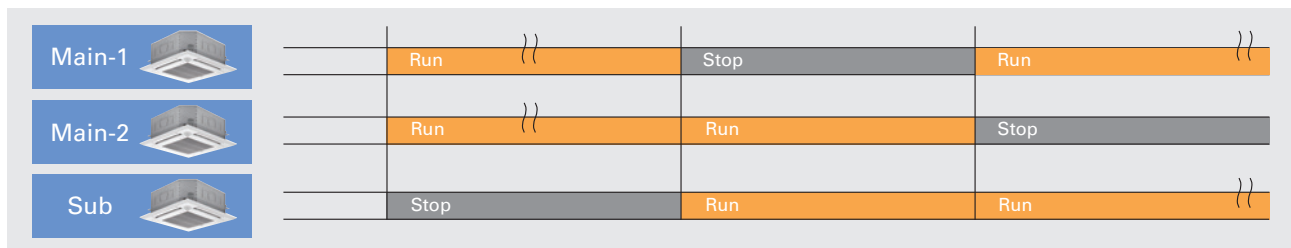

### Cut-in Function

If the actual room temperature greatly differs from the set temperature and two-refrigerant air conditioning system is insufficient, the standby unit starts operation to provide support.

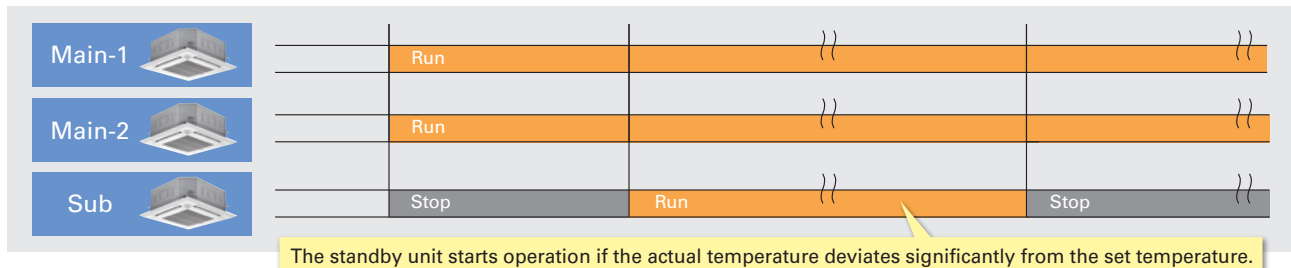

The standby unit starts operation if the actual temperature deviates significantly from the set temperature.

## Extended cooling set temperature range\*

In environments such as gyms where people do strenuous exercise, even if the room is cooled to an appropriate temperature, people may feel that it is hot, and they need a cooler air. To satisfy such demands, we have extended the lower limit of the cooling set temperature range from 19–30°C. to 14–30°C.

\*Insulation kit (PAC-SK36HK-E) is required when indoor unit is PLA series.

\*Availability of this function is depending on outdoor unit, indoor unit and remote controller.

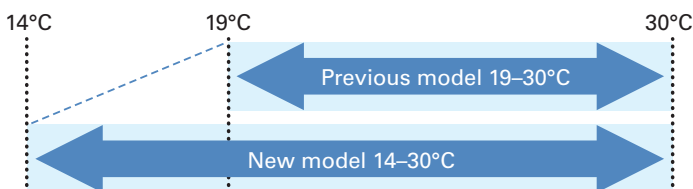

## Display of model names and serial numbers\*

The model names and serial numbers of the indoor/outdoor units that are connected to the MA smart remote controller can be automatically acquired and displayed through one simple operation. This eliminates the need to directly check each unit and helps with inquiries in the case of an abnormality.

\*Availability of this function is depending on outdoor unit, indoor unit and remote controller.

● Model name display (example)

```
Collect model names and S/N
0 OU PUZ-ZM200YKA2
  IU1 PLA-ZM50EA2
  IU2 PLA-ZM50EA2
  IU3 PLA-ZM50EA2
  IU4 PLA-ZM50EA2
```

Collect data:  -Address + S/N

● Serial number display (example)

```
Collect model names and S/N
0 OU 1ZU00001
  IU1 1ZA00001
  IU2 1ZA00002
  IU3 1ZA00003
  IU4 1ZA00004
```

Collect data:  -Address + Model

## Preliminary error history\*

In addition to error history, the history of preliminary abnormalities can be displayed. The feature enables the unit status check during inspection and maintenance.

\*Availability of this function is depending on outdoor unit, indoor unit and remote controller.

### ●Error history (Sample)

Error history		1/4
Error	Unt# dd/mm/yy	
E0	0-1 21/10/20 PM12:34	
E0	0-1 20/12/20 AM 1:23	
E0	0-1 20/11/20 PM10:55	
E0	0-1 20/10/20 PM12:01	

Error history menu: ↻

▼ Page ▲ Delete

### ●Preliminary error history (Sample)

Preliminary error hist.		1/8
Error	Unt# dd/mm/yy	
E0	0-1 21/10/20 PM12:34	
E0	0-1 20/12/20 AM 1:23	
E0	0-1 20/11/20 PM10:55	
E0	0-1 20/10/20 PM12:01	

Error history menu: ↻

▼ Page ▲ Delete

## Display of power consumption\*

It is possible to measure, acquire, and display the amount of energy used by each air conditioning system.

\*Availability of this function is depending on outdoor unit, indoor unit and remote controller.

< Data Collection Period >

Time data: Every 30 minutes over the past month

Monthly/daily data: Monthly over the past 14 months

Energy consumption values are calculated from estimated power consumption values according to the operating conditions. They may vary from the actual power consumption values. Please note that the power consumption of optional parts is not included except in the case of optional parts that have their power supplied directly by the outdoor unit.

### ●Every 30 minutes (example)

Energy data	
2019-1-1	1234.5kWh 1/6
0:30 123.4kWh	2:30 123.4kWh
1:00 123.4kWh	3:00 123.4kWh
1:30 123.4kWh	3:30 123.4kWh
2:00 123.4kWh	4:00 123.4kWh

Return: ↻

- Date + ▼ Page ▲

### ●Daily (example)

Energy data	
2019-1	123456.7kWh 1/4
31 1234.5kWh	27 1234.5kWh
30 1234.5kWh	26 1234.5kWh
29 1234.5kWh	25 1234.5kWh
28 1234.5kWh	24 1234.5kWh

Return: ↻

▼ Page ▲

### ●Monthly (example)

Energy data	
▶2019-1	123456.7kWh 1/3
2018-12	123456.7kWh
2018-11	123456.7kWh
2018-10	123456.7kWh
2018-9	123456.7kWh

View daily data: ✓

▼ Cursor ▲

## Improved defrosting performance\*

\*Availability of this function is depending on outdoor unit, indoor unit and remote controller.

### Avoiding Simultaneous Defrosting

When each of multiple units is in operation for heating in the same space, these may start defrosting at the same time, resulting in a drop in the room temperature. Therefore, we have developed a new function that controls up to four-refrigerant air conditioning system to avoid simultaneous defrosting. By ensuring that defrosting is only performed by one unit at a time, it is possible to minimize any decrease in room temperature.

#### Example System Configuration Four sets controlled by a single remote controller

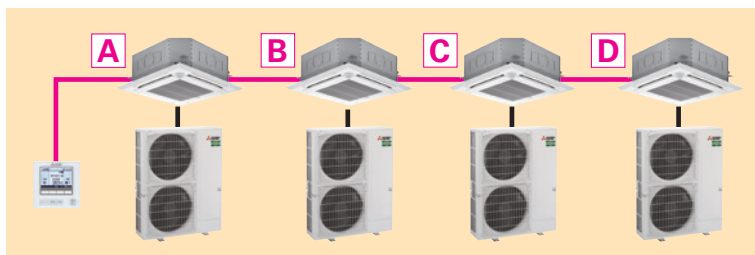

#### ■When All Sets Are Controlled Together

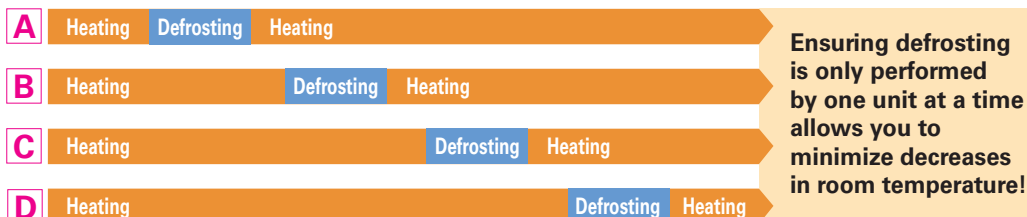

## Utilizing IoT for Improved Convenience\*

\*Availability of IoT functions are depending on MELCloud version.

By connecting to a MAC-587IFE Wi-Fi interface, it is possible to collect data and perform air conditioning control via MELCloud. In addition to basic functions such as turning the power on/off and setting the temperature, it is also possible to acquire data used for maintenance and inspection such as model names, serial numbers, and operation data.

### [Basic Operation Functions]

- Operation on/off ●Temperature setting
- Operation mode ●Airflow speed
- Airflow direction etc...

### [Data Collection and Display]

- Model name display ●Serial number display
- Collection of operation data
- Energy consumption display etc...

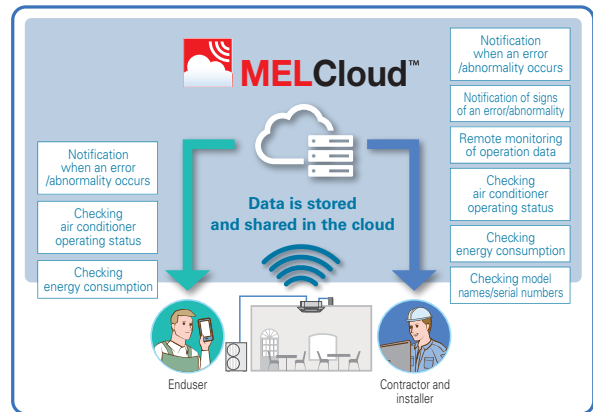

## MELCloud System Configuration

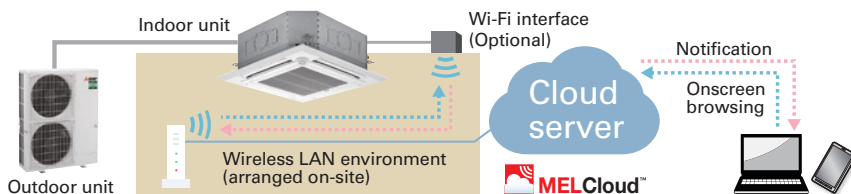

## Wi-Fi Adapter (Optional) Installation

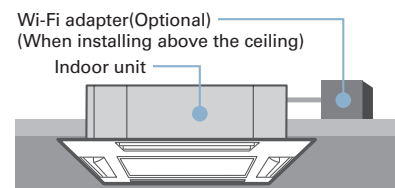

## On-Site Installation and Configuration

### ① Wireless LAN adapter installation

Connect the wireless LAN adapter to the indoor unit PCB and install it above the ceiling.

### ② Wireless LAN adapter and router connection settings

### ③ Wireless LAN adapter and server connection settings

## Collection of operation data

All the operation data required for maintenance and inspection can be collected in a simple step. This data can then be easily checked via MELcloud. This makes it easy to check the operating status data even in cases when it is difficult to do a visual inspection. This allows you to quickly identify any system malfunctions. This function also helps to improve the quality of installation work and shortening the time required for maintenance and inspection.

### Operation data that can be collected (example)

- Compressor frequency ●Compressor operating current ●Outdoor discharge temperature
- Outdoor heat exchanger temperature ●Outdoor air temperature ●Compressor shell temperature
- Sub cool ●Discharge superheat ●Indoor inlet temperature ●Indoor heat exchanger temperature
- Total compressor operating time●Compressor operation count ●Indoor filter operating time

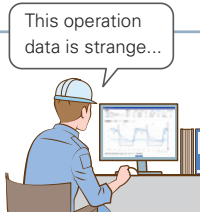

\*1 The total compressor operating time is displayed in units of 10 hours. The compressor operation count is displayed in units of 100.  
\*2 Indicates the elapsed time since a filter sign reset was performed.

## Demand control

It is possible to control air-conditioners to appropriately operate according to the energy supply-demand adjustment by electric power companies and each electricity rate plan of end users.

e.g. <Peak cut control> It is possible to utilize an external demand signal to reduce power consumption during peak hours. By satisfying the need for reducing peak power consumption or shifting consumption to a non-peak period, we have increased the range of options for our customers.

## Notification of potential abnormality

The comprehensive analysis of operating data allows the early detection of abnormalities in small functional parts by alerting the operator of any signs of abnormal behaviour. The recognition in advance of abnormalities in each unit further improves the ease of servicing and maintenance. Since this allows a countermeasure to be implemented before the abnormality requires the unit to be completely shut down, it is an effective method for maintaining the unit in its optimum condition.

### [Abnormalities That Have Their Signs Monitored]

- Filter blockage ●Drain blockage ●Refrigerant leakage
- Heat exchanger blockage etc...

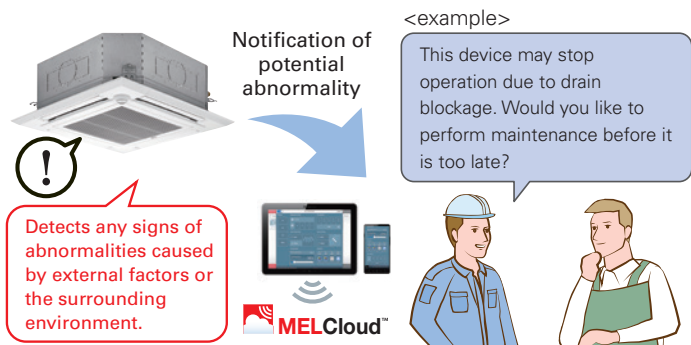



# PLA SERIES

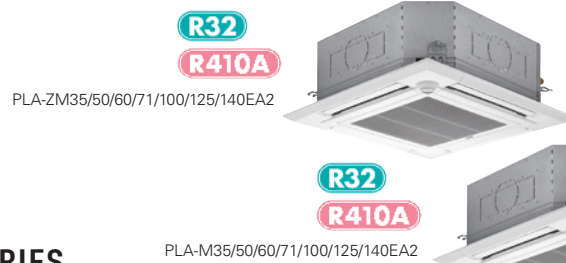

A complete line-up including deluxe units that offer added energy savings. The incorporation of "3D total flow" and the "3D i-see Sensor" enhances airflow distribution control, achieving an enhanced level of comfort throughout the room. The synergy of higher energy efficiency and more comfortable room environment results in the utmost user satisfaction.

## Deluxe 4-way Cassette Line-up

For users seeking even further energy savings, Mitsubishi Electric now offers deluxe units (PLA-ZM) to complete the line-up of models in this series, from 35-140. Compared to the standard models (PLA-M), deluxe models provide additional energy savings, contributing to a significant reduction in electricity costs.

### Line-up

Series	Model	35	50	60	71	100	125	140
R32	Deluxe 4-way Cassette (PLA-ZM)	●	●	●	●	●	●	●
R32	Standard 4-way Cassette (PLA-M)	●	●	●	●	●	●	●

### Indoor/Outdoor Unit Combinations

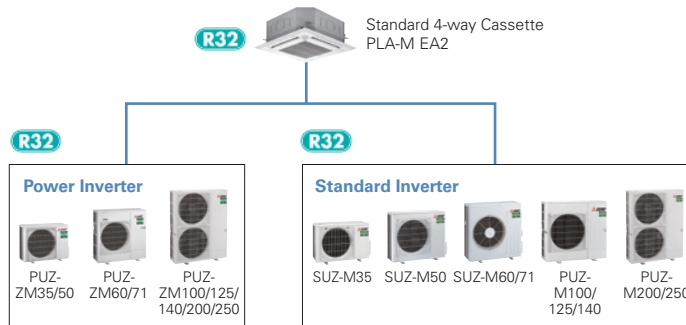
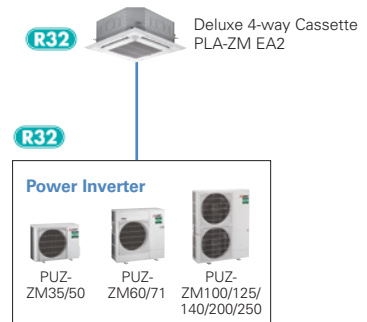

## Industry-leading energy efficiency

Introduction of R32 refrigerant realises improved cooling efficiency. Rating of more than 7.0 achieved for all capacity range. Introduction of R32 refrigerant reduces energy consumption and realises energy savings.

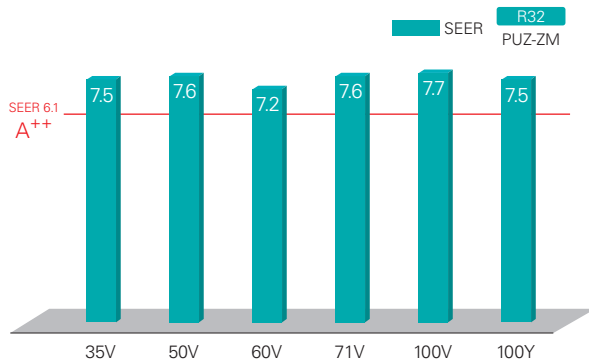

## Horizontal Airflow

The new airflow control removes that uncomfortable drafty feeling with the introduction of a horizontal airflow that spreads across the ceiling. The ideal airflow for offices and restaurants.



[Horizontal airflow]  
Model name: PLA-ZM140EA2  
Ceiling height: 3.2m  
Mode: Cooling

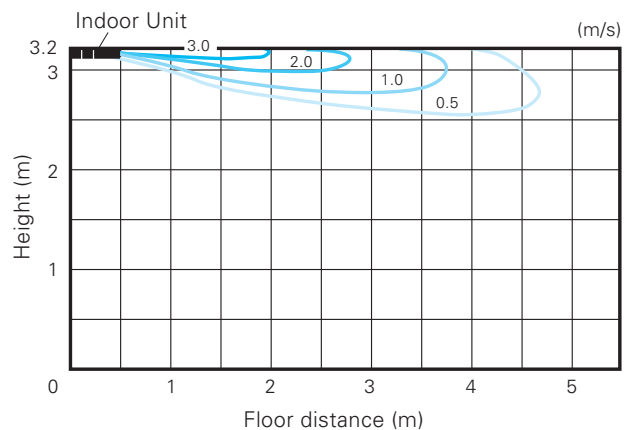

## Automatic Grille Lowering Function (PLP-6EAJ, PLP-6EAJE)\*

An automatic grille lowering function is available for easy filter maintenance. Special wired and wireless remote controllers can be used to lower the intake grille for maintenance.

\*Auto elevation panel(PLP-6EAJ,PLP-6EAJE) cannot be used with Plasma Quad Connect(PAC-SK51TFE) and Insulation kit (PAC-SK36HK-E).



Grille Elevation Remote Controller  
(comes with the automatic elevation panel)



Wired Remote Controller



Wireless Remote Controller

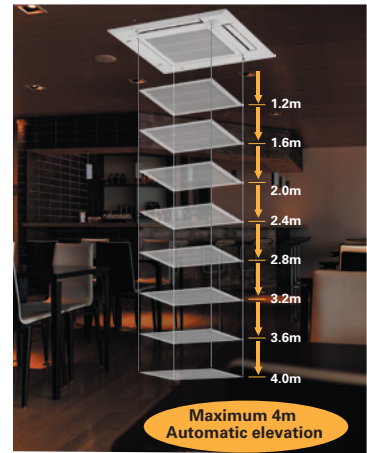

## Easy Installation

### Electrical box wiring

After reviewing the power supply terminal position in the electrical box, the structure was redesigned to improve connectivity. This has made previously complex wiring work easier.

■ Previous model (B Series)

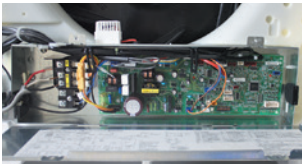

■ New model (E Series)



### Increased space for plumbing work

The top and bottom positions of the liquid and gas pipes have been reversed to allow the gas pipe work, which requires more effort, to be completed first. Further, through structural innovations related to the space around the pipes, the area where the spanner can be moved has been increased, thus improving liquid pipe work and enabling it to be completed smoothly.

■ Previous model (B Series)

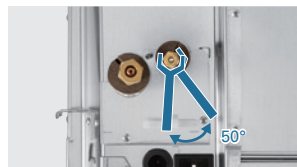

■ New model (E Series)



### Temporary hanging hook

The structure of the panel has been revised and is now equipped with a temporary hanging hook. This has improved work efficiency during panel installation.



### No need to remove screws

Installation is possible without removing the screws for the corner panel and the control box, simply loosen them. This lowers the risk of losing screws.

■ Corner panel



■ Control box cover



### Lightweight decorative panel

After reviewing the structure and materials, weight has been reduced approximately 20% compared to the previous model, reducing the burden of installation.



## 3D i-see Sensor for S & P SERIES

### Detects number of people

3D i-see Sensor detects the number of people in the room and sets the air-conditioning power accordingly. This makes automatic power-saving operation possible in places where the number of people entering and exiting is large. Additionally, when the area is continuously unoccupied, the system switches to a more enhanced power-saving mode. Depending on the setting, it will save additional capacity or stop operation altogether.



Detects number of people

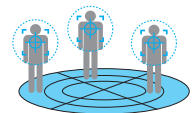

Detects people's position



### Detects people's position

Once the position of a person is detected, the duct angle of the vane is automatically adjusted in that direction. Each vane can be independently set to "block wind" or "not block wind" according to taste.

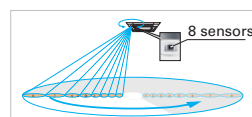

Detects position and number of people

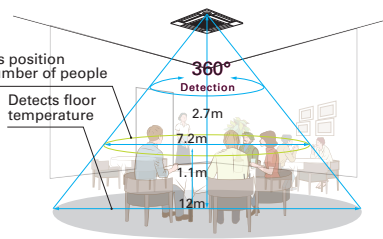

Detects floor temperature

Floor surface \*In case of a 2.7m ceiling

## Detects number of people (3D i-see Sensor)

### Room occupancy energy-saving mode

The 3D i-see Sensor detects the number of people in the room. It then calculates the occupancy rate based on the maximum number of people in the room up to that point in time in order to save air-conditioning power. When the occupancy rate is approximately 30%, air-conditioning power equivalent to 1°C during both cooling and heating operation is saved. The temperature is controlled according to the number of people.

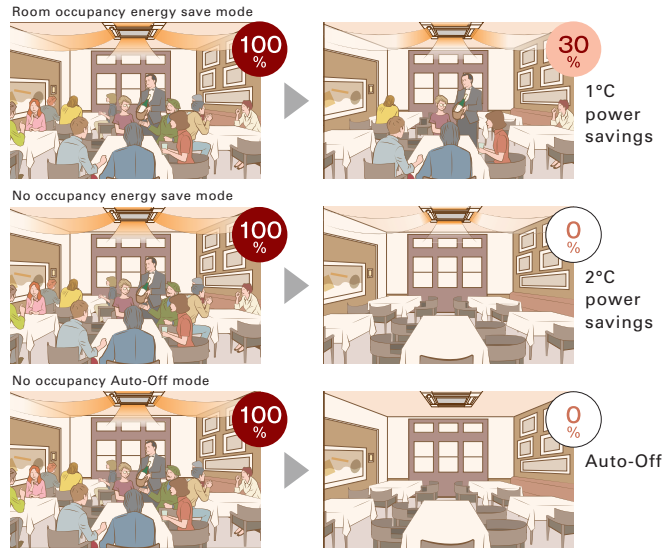

### No occupancy energy-saving mode

When 3D i-see Sensor detects that no one is in the room, the system is switched to a pre-set power-saving mode. If the room remains unoccupied for more than 60min, air-conditioning power equivalent to 2°C during both cooling and heating operation is saved. This contributes to preventing waste in terms of heating and cooling.

### No occupancy Auto-Off mode\*

When the room remains unoccupied for a pre-set period of time, the air conditioner turns off automatically, thereby providing even greater power savings. The time until operation is stopped can be set in intervals of 10min, ranging from 60 to 180 min.

\* When MA Remote Controller is used to control multiple refrigerant systems, "No occupancy Auto-Off mode" cannot be used.

## Detects people's position (3D i-see Sensor)

### Direct/Indirect settings\*

Some people do not like the feel of wind, some want to be warm from head to toe. People's likes and dislikes vary. With the 3D i-see Sensor, it is possible to choose to block or not block to the wind for each vane.



\*PAR-41MAA or PAR-SL101A-E is required for each setting.

### Seasonal airflow\*

#### <When cooling>

Saves energy while keeping a comfortable effective temperature by automatically switching between ventilation and cooling. When a pre-set temperature is reached, the air conditioning unit switches to swing fan operation to maintain the effective temperature. This clever function contributes to keeping a comfortable coolness.

#### <When heating>

The air conditioning unit automatically switches between circulator and heating. Wasted heat that accumulates near the ceiling is reused via circulation. When a pre-set temperature is reached the air conditioner switches from heating to circulator and blows air in the horizontal direction. It pushes down the warm air that has gathered near the ceiling to people's height, thereby providing smart heating.

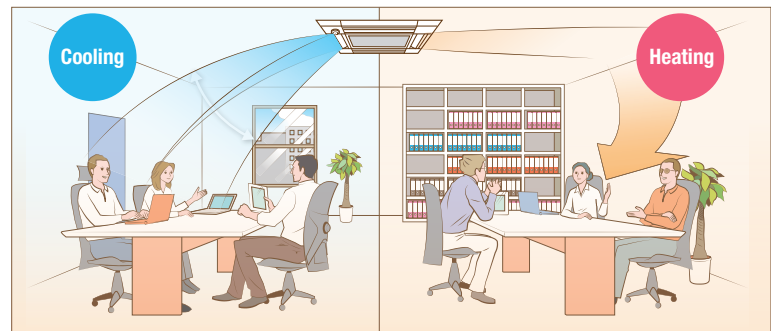

\*PAR-41MAA is required for each setting.

## 3D Total Flow\*

3D Total Flow is an innovative function. Our original 3D i-see sensor detects the temperature of the floor, and then the newly installed 3D Total Flow unit automatically controls the airflow in the left/right directions in a smart manner.

\*3D Total Flow unit(PLP-U160ELR-E) cannot be used with Plasma Quad Connect(PAC-SK51FTE), Insulation kit(PAC-SK36HK-E), Shutter Plate(PAC-SJ37SP-E), Multi functional casement(PAC-SJ41TM-E) and High-efficiency filter element(PAC-SH59KF-E)

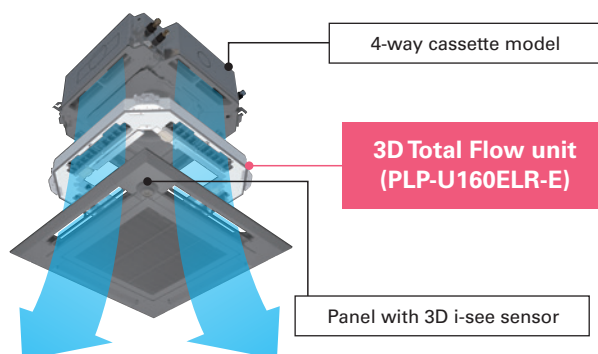

## Horizontal louver (3D Total Flow)

In addition to the ability of conventional models to control airflow in the vertical direction, the adoption of a horizontal louver unit allows each outlet to blow air over a horizontal angle of 90 degrees. The combination of four outlets delivers 360° airflow control around the entire circumference. This now makes it possible to blow air in diagonal directions which eliminates temperature irregularities.

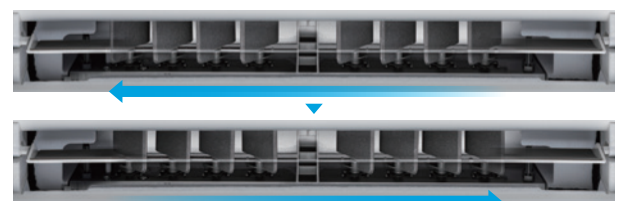

louvers can provide horizontal airflow control.

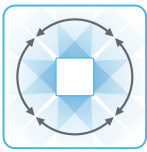

### Swinging

Since airflow can be controlled in the horizontal and vertical directions, you can efficiently make the entire room comfortable.

#### Horizontal, vertical, and diagonal airflow delivered to every corner

The combination of the vertical vanes with the horizontal louver unit makes it possible to direct airflow in any direction. This quickly makes the entire room comfortable, even when diagonal airflow is necessary.

Without 3D Total Flow



There are some areas that cannot receive air through vertical airflow control.

With 3D Total Flow

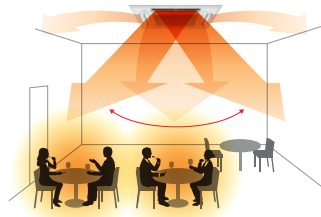

Swinging in both the vertical and horizontal directions provides a pleasant breeze throughout the room.

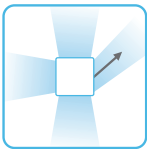

### Targeting

The system can detect spaces with uneven temperatures and target them by sending air even if they are in a diagonal direction.

#### Detects and targets areas with uneven temperatures

3D i-see sensor detects areas with uneven temperatures, even if they are caused by the installation orientation of the air conditioner or the influence of strong sunlight. Efficient air conditioning is possible thanks to the ability to send focused airflow to such areas, even those in a diagonal position.

Without 3D Total Flow

Depending on application, conventional systems may take a long time to cool down hot spots.

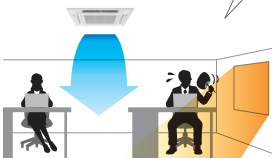

With 3D Total Flow

The new system efficiently eliminates hot spots by using targeted airflow.

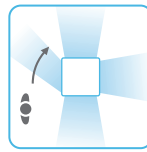

### Indirect mode

When set to "Indirect" mode, the system detects the position of a person and maintains comfort while diverting airflow away from them.

#### Prevents direct airflow and keeps you comfortable

This function prevents people from being directly exposed to airflow while still ensuring comfort. The "Indirect" mode of 3D Total Flow keeps the downward airflow while avoiding direct blow to people, delivering a pleasant warmth.

Without 3D Total Flow

Models that are only equipped with vertical vanes need to swing the airflow upward to avoid people. This makes it difficult to warm up the surrounding space.



With 3D Total Flow

Now, it is easier to warm the surrounding space while still ensuring people do not receive direct blow.



\*If people are present throughout the entire airflow range of an outlet, the airflow is shifted horizontally to avoid direct airflow.

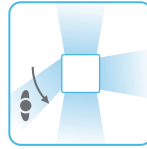

### Direct mode

When set to "Direct" mode, the system detects the position and diverts airflow towards wherever they are located.

#### Delivers airflow even in diagonal directions

You can freely turn on "Direct" mode depending on personal preference. This allows for air conditioning in diagonal directions which was difficult for models that could only swing the airflow up and down. This feature is perfect for when you come back home on a hot day.

Without 3D Total Flow

It is difficult to direct airflow in diagonal directions when only using vertical vanes.

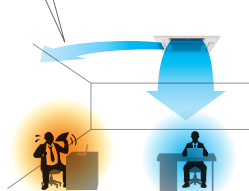

With 3D Total Flow

Ensures comfort even when you are located diagonally from an outlet.

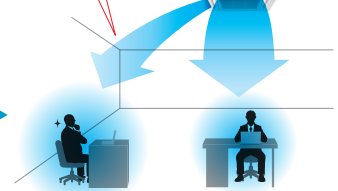

## Connectable to *Plasma Quad Connect*\*

The optional Plasma Quad Connect PAC-SK51FTE can be installed on the indoor units.

\*Plasma Quad Connect(PAC-SK51FTE) cannot be used with PLP-U160ELR-E(3D Total Flow unit), Insulation kit (PAC-SK36HK-E), Auto elevation panel(PLP-6EAJ, PLP-6EAJE), Multi functional casement(PAC-SJ41TM-E) and High-efficiency filter element(PAC-SH59KF-E).

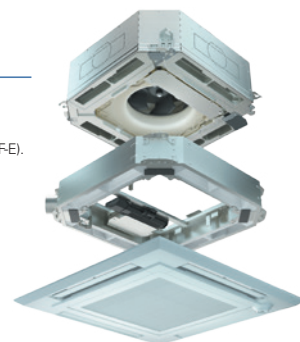

## SERIES SELECTION

### Power Inverter Series



#### Indoor Unit

**R32**  
**R410A**



Panel PLA-ZM35/50/60/71/100/125/140EA2

Panel	With Signal Receiver	With 3D i-see Sensor	With Wireless Remote Controller	With Auto Elevation
PLP-6EA(B)				
PLP-6EAL	✓			
PLP-6EAE		✓		
PLP-6EALE	✓	✓		
PLP-6EAJ*	✓			✓
PLP-6EAJE*	✓	✓		✓
PLP-6EALM2	✓		✓	
PLP-6EALME2	✓	✓	✓	

\*Auto elevation panel(PLP-6EAJ,PLP-6EAJE) cannot be used with Plasma Quad Connect(PAC-SK51FT-E) and Insulation kit (PAC-SK36HK-E).

#### Outdoor Unit

**R32**

For Single



PUZ-ZM35/50      PUZ-ZM60/71      PUZ-ZM100/125/140

**R32**

For Multi  
(Twin/Triple/Quadruple)



PUZ-ZM71      PUZ-ZM100/125/140/200/250

#### 3D Total Flow Unit

PLP-U160ELR-E (optional)



#### Black Panel

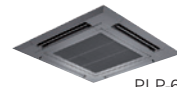

PLP-6EAB (optional)

#### Remote Controller



Optional



Optional



Optional



\* Enclosed in PLP-6EALM2/ PLP-6EALME2

### PLA-ZM EA2 Indoor Unit Combinations

Indoor unit combinations shown below are possible.

Indoor Unit Combination	Outdoor Unit Capacity																					
	For Single									For Twin					For Triple			For Quadruple				
	35	50	60	71	100	125	140	200	250	71	100	125	140	200	250	140	200	250	200	250		
Power Inverter (PUZ-ZM)	35x1	50x1	60x1	71x1	100x1	125x1	140x1	-	-	35x2	50x2	60x2	71x2	100x2	125x2	50x3	60x3	71x3	50x4	60x4		
Distribution Pipe	-	-	-	-	-	-	-	-	-	MSDD-50TR2-E					MSDD-50WR2-E			MSDF-111R3-E			MSDF-111R2-E	

## SERIES SELECTION

### Standard Inverter Series



#### Indoor Unit

**R32**  
**R410A**



Panel PLA-M35/50/60/71/100/125/140EA2

Panel	With Signal Receiver	With 3D i-see Sensor	With Wireless Remote Controller	With Auto Elevation
PLP-6EA(B)				
PLP-6EAL	✓			
PLP-6EAE		✓		
PLP-6EALE	✓	✓		
PLP-6EAJ*	✓			✓
PLP-6EAJE*	✓	✓		✓
PLP-6EALM2	✓		✓	
PLP-6EALME2	✓	✓	✓	

\*Auto elevation panel(PLP-6EAJ,PLP-6EAJE) cannot be used with Plasma Quad Connect(PAC-SK51FT-E) and Insulation kit (PAC-SK36HK-E).

#### Outdoor Unit

**R32**

For Single



SUZ-M35      SUZ-M50      SUZ-M60/71      PUZ-M100/125/140

**R32**

For Multi  
(Twin/Triple/Quadruple)



PUZ-M100/125/140      PUZ-M200/250

#### 3D Total Flow Unit

PLP-U160ELR-E\* (optional)

\*SUZ combination is not available.

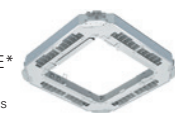

#### Black Panel

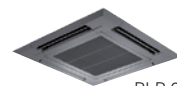

PLP-6EAB (optional)

#### Remote Controller



Optional



Optional



Optional



\* Enclosed in PLP-6EALM2/ PLP-6EALME2

### PLA-M EA2 Indoor Unit Combinations

Indoor unit combinations shown below are possible.

Indoor Unit Combination	Outdoor Unit Capacity																					
	For Single									For Twin					For Triple			For Quadruple				
	35	50	60	71	100	125	140	200	250	71	100	125	140	200	250	140	200	250	200	250		
Standard Inverter (SUZ & PUZ-M)	35x1	50x1	60x1	71x1	100x1	125x1	140x1	-	-	50x2	60x2	71x2	100x2	125x2	50x3	60x3	71x3	50x4	60x4			
Distribution Pipe	-	-	-	-	-	-	-	-	-	MSDD-50TR2-E					MSDD-50WR2-E			MSDF-111R3-E			MSDF-111R2-E	

# PLA-ZM SERIES

## POWER INVERTER



Type		Inverter Heat Pump										
Indoor Unit		PLA-M35EA2	PLA-M50EA2	PLA-M60EA2	PLA-M71EA2	PLA-M100EA2	PLA-M100EA2	PLA-M125EA2	PLA-M125EA2	PLA-M140EA2	PLA-M140EA2	
Outdoor Unit		PUZ-M35VKA2	PUZ-M50VKA2	PUZ-M60VHA2	PUZ-M71VHA2	PUZ-M100VKA2	PUZ-M100VKA2	PUZ-M125VKA2	PUZ-M125VKA2	PUZ-M140VKA2	PUZ-M140VKA2	
Refrigerant (*)		R32										
Power Supply		Outdoor power supply										
Source		VKA-VHA:230/Single/50, YKA:400/Three/50										
Outdoor(V/Phase/Hz)												
Cooling	Capacity	Rated	3.6	5.0	6.1	7.1	9.5	9.5	12.5	12.5	13.4	13.4
		Min-Max	1.6 - 4.5	2.3 - 5.6	2.7 - 6.5	3.3 - 8.1	4.9 - 11.4	4.9 - 11.4	5.5 - 14.0	5.5 - 14.0	6.2 - 15.0	6.2 - 15.0
	Total Input	Rated	0.705	1.106	1.452	1.651	2.159	2.159	3.378	3.378	3.722	3.722
	EER		5.10	4.52	4.20	4.30	4.40	4.40	3.70	3.70	3.60	3.60
	Design load		3.6	5.0	6.1	7.1	9.5	9.5	12.5	12.5	13.4	13.4
Heating	Capacity	Rated	4.1	6.0	7.0	8.0	11.2	11.2	14.0	14.0	16.0	16.0
		Min-Max	1.6 - 5.2	2.5 - 7.3	2.8 - 8.2	3.5 - 10.2	4.5 - 14.0	4.5 - 14.0	5.0 - 16.0	5.0 - 16.0	5.7 - 18.0	5.7 - 18.0
	Total Input	Rated	0.820	1.363	1.707	1.818	2.604	2.604	3.674	3.674	4.312	4.312
	COP		5.00	4.40	4.10	4.40	4.30	4.30	3.81	3.81	3.71	3.71
	Design load		2.5	3.8	4.4	4.7	7.8	7.8	11.2	11.2	13.4	13.4

\*1 Refrigerant leakage contributes to climate change. Refrigerant with lower global warming potential (GWP) would contribute less to global warming than a refrigerant with higher GWP if leaked to the atmosphere. This appliance contains a refrigerant fluid with a GWP equal to 560. This means that if 1 kg of this refrigerant fluid would be leaked to the atmosphere, the impact on global warming would be 560 times higher than 1 kg of CO<sub>2</sub> over a period of 100 years. Never try to interfere with the refrigerant circuit yourself or disassemble the product yourself and always ask a professional. The GWP of R32 is 675 in the IPCC 4th Assessment Report.

\*2 Energy consumption based on standard test results. Actual energy consumption will depend on how the appliance is used and where it is located.

\*3 Optional air protection guide is required where ambient temperature is lower than -5°C.

\*4 SEER and SCOP are based on 2009/125/EC:Energy-related Products Directive and Regulation(EU) No206/2012. \*5 Joint pipe is required depending on installed refrigerant pipes, outdoor units and indoor units.

# PLA-M SERIES

## STANDARD INVERTER



Type		Inverter Heat Pump										
Indoor Unit		PLA-M35EA2	PLA-M50EA2	PLA-M60EA2	PLA-M71EA2	PLA-M100EA2	PLA-M100EA2	PLA-M125EA2	PLA-M125EA2	PLA-M140EA2	PLA-M140EA2	
Outdoor Unit		SUZ-M35VA	SUZ-M50VA	SUZ-M60VA	SUZ-M71VA	SUZ-M100VKA2	SUZ-M100VKA2	SUZ-M125VKA2	SUZ-M125VKA2	SUZ-M140VKA2	SUZ-M140VKA2	
Refrigerant (*)		R32										
Power Supply		Outdoor power supply										
Source		VA-VKA:230/Single/50, YKA:400/Three/50										
Outdoor(V/Phase/Hz)												
Cooling	Capacity	Rated	3.6	5.5	6.1	7.1	9.5	9.5	12.1	12.1	13.4	13.4
		Min-Max	0.8 - 3.9	1.2 - 5.6	1.6 - 6.3	2.2 - 8.1	4.0 - 10.6	4.0 - 10.6	5.8 - 13.0	5.8 - 13.0	5.8 - 14.1	5.8 - 14.1
	Total Input	Rated	0.900	1.617	1.848	1.918	2.714	2.714	4.019	4.019	4.962	4.962
	EER		4.00	3.40	3.30	3.70	3.50	3.50	3.01	3.01	2.70	2.70
	Design load		3.6	5.5	6.1	7.1	9.5	9.5	12.1	12.1	13.4	13.4
Heating	Capacity	Rated	4.1	6.0	7.0	8.0	11.2	11.2	13.5	13.5	15.0	15.0
		Min-Max	1.0 - 5.0	1.5 - 7.2	1.6 - 8.0	2.0 - 10.2	2.8 - 12.5	2.8 - 12.5	4.1 - 15.0	4.1 - 15.0	4.2 - 15.8	4.2 - 15.8
	Total Input	Rated	0.976	1.734	1.842	2.216	3.018	3.018	3.638	3.638	4.398	4.398
	COP		4.20	3.46	3.80	3.61	3.71	3.71	3.71	3.71	3.41	3.41
	Design load		2.6	4.3	4.6	5.8	8.0	8.0	11.2	11.2	13.4	13.4

\*1 Refrigerant leakage contributes to climate change. Refrigerant with lower global warming potential (GWP) would contribute less to global warming than a refrigerant with higher GWP if leaked to the atmosphere. This appliance contains a refrigerant fluid with a GWP equal to 560. This means that if 1 kg of this refrigerant fluid would be leaked to the atmosphere, the impact on global warming would be 560 times higher than 1 kg of CO<sub>2</sub> over a period of 100 years. Never try to interfere with the refrigerant circuit yourself or disassemble the product yourself and always ask a professional. The GWP of R32 is 675 in the IPCC 4th Assessment Report.

\*2 Energy consumption based on standard test results. Actual energy consumption will depend on how the appliance is used and where it is located.

\*3 Optional air protection guide is required where ambient temperature is lower than -5°C.

\*4 SEER and SCOP are based on 2009/125/EC:Energy-related Products Directive and Regulation(EU) No206/2012. \*5 Joint pipe is required depending on installed refrigerant pipes, outdoor units and indoor units.

# PLA-M SERIES

## POWER INVERTER



Type			Inverter Heat Pump										
Indoor Unit			PLA-M35EA2	PLA-M50EA2	PLA-M60EA2	PLA-M71EA2	PLA-M100EA2	PLA-M100EA2	PLA-M125EA2	PLA-M125EA2	PLA-M140EA2	PLA-M140EA2	
Outdoor Unit			PUZ-ZM35VKA2	PUZ-ZM50VKA2	PUZ-ZM60VHA2	PUZ-ZM71VHA2	PUZ-ZM100VKA2	PUZ-ZM100VKA2	PUZ-ZM125VKA2	PUZ-ZM125VKA2	PUZ-ZM140VKA2	PUZ-ZM140VKA2	
Refrigerant <sup>(1)</sup>			R32										
Power Supply			Outdoor power supply										
Source			VKA · VHA:230/Single/50, YKA:400/Three/50										
Outdoor(V/Phase/Hz)													
Cooling	Capacity	Rated	kW	3.6	5.0	6.1	7.1	9.5	9.5	12.5	12.5	13.4	13.4
		Min-Max	kW	1.6 - 4.5	2.3 - 5.6	2.7 - 6.5	3.3 - 8.1	4.9 - 11.4	4.9 - 11.4	5.5 - 14.0	5.5 - 14.0	6.2 - 15.0	6.2 - 15.0
	Total Input	Rated	kW	0.751	1.175	1.523	1.716	2.209	2.209	3.396	3.396	3.746	3.746
	EER			4.79	4.25	4.00	4.14	4.30	4.30	3.68	3.68	3.58	3.58
	Design load		kW	3.6	5.0	6.1	7.1	9.5	9.5	—	—	—	—
	Annual electricity consumption <sup>(2)</sup>		kWh/a	172	234	301	336	437	448	—	—	—	—
Heating (Average Season)	Capacity	Rated	kW	4.1	6.0	7.0	8.0	11.2	11.2	14.0	14.0	16.0	16.0
		Min-Max	kW	1.6 - 5.2	2.5 - 7.3	2.8 - 8.2	3.5 - 10.2	4.5 - 14.0	4.5 - 14.0	5.0 - 16.0	5.0 - 16.0	5.7 - 18.0	5.7 - 18.0
	Total Input	Rated	kW	0.890	1.581	1.863	2.014	2.685	2.685	3.773	3.773	4.365	4.365
	COP			4.61	3.79	3.76	3.97	4.17	4.17	3.71	3.71	3.67	3.67
	Design load		kW	2.5	3.8	4.4	4.7	7.8	7.8	—	—	—	—
	Declared Capacity	at reference design temperature	kW	2.5 (-10°C)	3.8 (-10°C)	4.4 (-10°C)	4.7 (-10°C)	7.8 (-10°C)	7.8 (-10°C)	—	—	—	—
		at bivalent temperature	kW	2.5 (-10°C)	3.8 (-10°C)	4.4 (-10°C)	4.7 (-10°C)	7.8 (-10°C)	7.8 (-10°C)	—	—	—	—
		at operation limit temperature	kW	2.1 (-11°C)	3.7 (-11°C)	2.8 (-20°C)	3.4 (-20°C)	5.8 (-20°C)	5.8 (-20°C)	—	—	—	—
	Back up heating capacity		kW	0.0	0.0	0.0	0.0	0.0	0.0	—	—	—	—
	Annual electricity consumption <sup>(2)</sup>		kWh/a	798	1187	1422	1429	2496	2497	—	—	—	—
SCOP <sup>(4)</sup>			4.3	4.4	4.3	4.6	4.3	4.3	—	—	—	—	
Operating	Current(Max)		A	13.2	13.2	19.2	19.3	20.5	8.5	27.2	9.7	30.7	12.5
		Input [cooling / Heating]	Rated	kW	0.03 / 0.03	0.03 / 0.03	0.03 / 0.03	0.04 / 0.04	0.07 / 0.07	0.07 / 0.07	0.10 / 0.10	0.10 / 0.10	0.10 / 0.10
Indoor Unit	Operating Current(Max)		A	0.20	0.22	0.24	0.27	0.46	0.46	0.66	0.66	0.66	0.66
		Dimensions	H*W*D	mm	258-840-840 <40-950-950>								298-840-840 <40-950-950>
	Weight		kg	19 <6>	19 <6>	21 <6>	21 <6>	24 <6>	24 <6>	26 <6>	26 <6>	26 <6>	26 <6>
	Air Volume (Lo-Mid-Hi)		m³/min	11-13-15-16	12-14-16-18	12-14-16-18	14-17-19-21	19-23-26-29	19-23-26-29	21-25-28-31	21-25-28-31	24-26-29-32	24-26-29-32
	Sound Level (Lo-Mid-Hi) (SPL)		dB(A)	26-28-29-31	27-29-31-32	27-29-31-32	28-30-32-34	31-34-37-40	31-34-37-40	33-37-41-44	33-37-41-44	36-39-42-44	36-39-42-44
	Sound Level (PWL)		dB(A)	51	54	54	56	61	61	65	65	65	65
Outdoor Unit	Dimensions	H*W*D	mm	630-809-300	630-809-300	943-950-330(+25)	943-950-330(+25)	1338-1050-330(+40)	1338-1050-330(+40)	1338-1050-330(+40)	1338-1050-330(+40)	1338-1050-330(+40)	1338-1050-330(+40)
		Weight	kg	46	46	67	67	105	111	105	114	105	118
	Air Volume	Cooling	m³/min	45	45	55	55	110	110	120	120	120	120
		Heating	m³/min	45	45	55	55	110	110	120	120	120	120
	Sound Level (SPL)	Cooling	dB(A)	44	44	47	47	49	49	50	50	50	50
		Heating	dB(A)	46	46	49	49	51	51	52	52	52	52
	Sound Level (PWL)	Cooling	dB(A)	65	65	67	67	69	69	70	70	70	70
	Operating Current(Max)		A	13	13	19	19	20	8	26.5	9	30	11.8
Breaker Size		A	16	16	25	25	32	16	32	16	40	16	
Ext.Piping	Diameter <sup>(3)</sup>	Liquid/Gas	mm	6.35 / 12.7	6.35 / 12.7	9.52 / 15.88	9.52 / 15.88	9.52 / 15.88	9.52 / 15.88	9.52 / 15.88	9.52 / 15.88	9.52 / 15.88	9.52 / 15.88
	Max.Length	Out-In	m	50	50	55	55	100	100	100	100	100	
	Max.Height	Out-In	m	30	30	30	30	30	30	30	30	30	
Guaranteed Operating Range (Outdoor)	Cooling <sup>(3)</sup>	°C	-15 ~ +46	-15 ~ +46	-15 ~ +46	-15 ~ +46	-15 ~ +46	-15 ~ +46	-15 ~ +46	-15 ~ +46	-15 ~ +46	-15 ~ +46	
	Heating	°C	-11 ~ +21	-11 ~ +21	-20 ~ +21	-20 ~ +21	-20 ~ +21	-20 ~ +21	-20 ~ +21	-20 ~ +21	-20 ~ +21	-20 ~ +21	

\*1 Refrigerant leakage contributes to climate change. Refrigerant with lower global warming potential (GWP) would contribute less to global warming than a refrigerant with higher GWP, if leaked to the atmosphere. This appliance contains a refrigerant fluid with a GWP equal to 550. This means that if 1 kg of this refrigerant fluid would be leaked to the atmosphere, the impact on global warming would be 550 times higher than 1 kg of CO<sub>2</sub>, over a period of 100 years. Never try to interfere with the refrigerant circuit yourself or disassemble the product yourself and always ask a professional. The GWP of R32 is 675 in the IPCC 4th Assessment Report.

\*2 Energy consumption based on standard test results. Actual energy consumption will depend on how the appliance is used and where it is located.

\*3 Optional air protection guide is required where ambient temperature is lower than -5°C.

\*4 SEER and SCOP are based on 2009/125/EC: Energy-related Products Directive and Regulation(EU) No206/2012.

\*5 Joint pipe is required depending on installed refrigerant pipes, outdoor units and indoor units.

# PEAD SERIES

R32  
R410A



PEAD-M35/50/60/71/100/125/140JA2



Energy efficiency has been improved. A reduced electricity consumption contributes to a further reduction in operating cost. The thin body with a wide-ranged external static pressure of this series is the perfect answer for the air conditioning needs of buildings with minimum ceiling installation space.

## ErP Lot-10 compliant, Achieving High Energy Efficiency



The shape of fan wing and casing is improved to provide more smooth air flow, increasing the operation efficiency. All models under 12kW(M35~M100) are complied with ErP Lot 10 and energy rankings of A++ for cooling and A+ for heating. This contributes to a reduction in the cost of annual electricity.

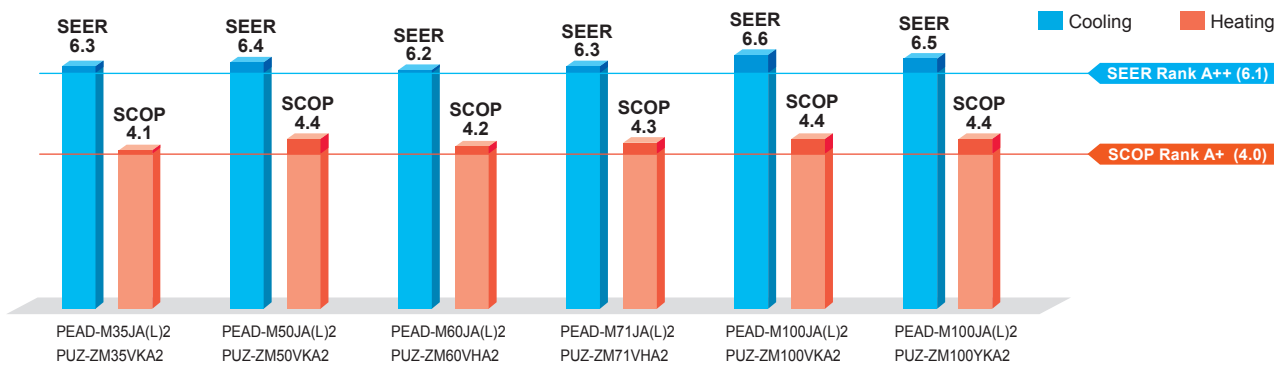

## Compact Indoor Units

The height of the models from 35-140 has been unified to 250 mm, which makes installation in low ceiling with minimal clearance space possible.

## Selectable Static Pressure Levels

External static pressure conversion can be set up to five levels. Capable of being set to a maximum of 150 Pa, units are applicable to a wide range of building types.

## Drain Pump is Optionally Selectable

The line-up consists of two types: models with or without a built-in drain pump, thus allowing more freedom in piping design.

- PEAD-M JA2 ▶ Built-in drain pump
- PEAD-M JAL2 ▶ No drain pump

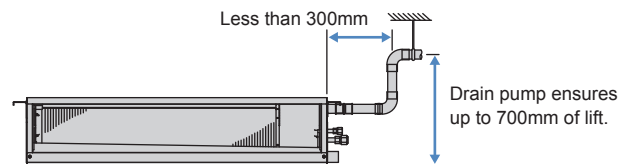

## Connectable to Plasma Quad Connect

The optional Plasma Quad Connect MAC-100FT-E can be installed on the indoor unit's air inlet side. For installation, PQ attachment or PQ box is required.



## SERIES SELECTION

### Power Inverter Series



#### Indoor Unit

**R32**  
**R410A**



PEAD-M35/50/60/71/100/125/140JA(L)2

#### Outdoor Unit

**R32**

For Single



PUZ-ZM35/50    PUZ-ZM60/71    PUZ-ZM100/125/140

**R32**

For Multi  
(Twin/Triple/Quadruple)



PUZ-ZM71    PUZ-ZM100/125/140/200/250

#### Remote Controller



\* PAR-SA9CA-E is also required.

**PEAD-M JA(L)2 Indoor Unit Combinations** Indoor unit combinations shown below are possible.

Indoor Unit Combination	Outdoor Unit Capacity																			
	For Single								For Twin				For Triple			For Quadruple				
	35	50	60	71	100	125	140	200	250	71	100	125	140	200	250	140	200	250	200	250
Power Inverter (PUZ-ZM)	35x1	50x1	60x1	71x1	100x1	125x1	140x1	-	-	35x2	50x2	60x2	71x2	100x2	125x2	50x3	60x3	71x3	50x4	60x4
Distribution Pipe	-	-	-	-	-	-	-	-	-	MSDD-50TR2-E				MSDD-50WR2-E		MSDT-111R3-E			MSDF-1111R2-E	

## SERIES SELECTION

### Standard Inverter Series



#### Indoor Unit

**R32**  
**R410A**

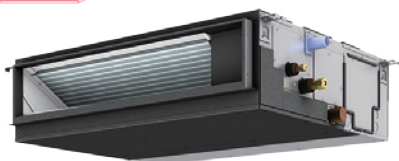

PEAD-M35/50/60/71/100/125/140JA(L)2

#### Outdoor Unit

**R32**

For Single



SUZ-M35    SUZ-M50    SUZ-M60/71    PUZ-M100/125/140

**R32**

For Multi  
(Twin/Triple/Quadruple)



PUZ-M100/125/140    PUZ-M200/250

#### Remote Controller



\* PAR-SA9CA-E is also required.

**PEAD-M JA(L)2 Indoor Unit Combinations** Indoor unit combinations shown below are possible.

Indoor Unit Combination	Outdoor Unit Capacity																			
	For Single								For Twin				For Triple			For Quadruple				
	35	50	60	71	100	125	140	200	250	71	100	125	140	200	250	140	200	250	200	250
Standard Inverter (PUZ-M&SUZ)	35x1	50x1	60x1	71x1	100x1	125x1	140x1	-	-	-	50x2	60x2	71x2	100x2	125x2	50x3	60x3	71x3	50x4	60x4
Distribution Pipe	-	-	-	-	-	-	-	-	-	MSDD-50TR2-E				MSDD-50WR2-E		MSDT-111R3-E			MSDF-1111R2-E	

# PEAD-M SERIES

POWER INVERTER

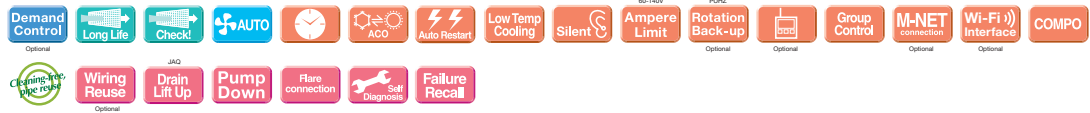

Type				Inverter Heat Pump									
Indoor Unit				PEAD-M35JAIL2	PEAD-M50JAIL2	PEAD-M60JAIL2	PEAD-M71JAIL2	PEAD-M100JAIL2	PEAD-M100JAIL2	PEAD-M125JAIL2	PEAD-M125JAIL2	PEAD-M140JAIL2	PEAD-M140JAIL2
Outdoor Unit				PUZ-ZM35VKA2	PUZ-ZM50VKA2	PUZ-ZM60VHA2	PUZ-ZM71VHA2	PUZ-ZM100VKA2	PUZ-ZM100VKA2	PUZ-ZM125VKA2	PUZ-ZM125VKA2	PUZ-ZM140VKA2	PUZ-ZM140VKA2
Refrigerant(*)				R32									
Power Supply				Outdoor power supply VKA-VHA:230/Single/50, YKA:400/Three/50									
Cooling				Capacity Rated kW 3.6 5.0 6.1 7.1 9.5 9.5 12.5 12.5 13.4 13.4									
Heating				Capacity Rated kW 4.1 6.0 7.0 8.0 11.2 11.2 14.0 14.0 16.0 16.0									
Operating Current(Max)				A 14.2 14.4 20.9 20.9 22.3 10.3 28.8 11.3 32.6 14.4									
Indoor Unit				Input (cooling / Heating) Rated kW 0.05 0.07 0.08 0.09 0.14 0.14 0.20 0.20 0.21 0.21									
Ext.Piping				Diameter(mm) 6.35/12.7 6.35/12.7 9.52/15.88 9.52/15.88 9.52/15.88 9.52/15.88 9.52/15.88 9.52/15.88 9.52/15.88 9.52/15.88									
Guaranteed Operating Range (Outdoor)				Cooling(°C) -15 ~ +46 -15 ~ +46 -15 ~ +46 -15 ~ +46 -15 ~ +46 -15 ~ +46 -15 ~ +46 -15 ~ +46 -15 ~ +46 -15 ~ +46									

\*1 Refrigerant leakage contributes to climate change. Refrigerant with lower global warming potential (GWP) would contribute less to global warming than a refrigerant with higher GWP if leaked to the atmosphere. This appliance contains a refrigerant fluid with a GWP equal to 560. This means that if 1 kg of this refrigerant fluid would be leaked to the atmosphere, the impact on global warming would be 560 times higher than 1 kg of CO<sub>2</sub> over a period of 100 years. Never try to interfere with the refrigerant circuit yourself or disassemble the product yourself and always ask a professional. The GWP of R32 is 675 in the IPCC 4th Assessment Report.  
 \*2 Energy consumption based on standard test results. Actual energy consumption will depend on how the appliance is used and where it is located.  
 \*3 Optional air protection guide is required where ambient temperature is lower than -5°C. \*4 EER/COP and SEER/SCOP for M35-71 are measured at ESP 35Pa, for M100 at ESP 37Pa, for M125/140 at ESP 50Pa.  
 \*5 SEER and SCOP are based on 2009/125/EC/Energy-related Products Directive and Regulation(EU) No206/2012. \*6 Joint pipe is required depending on installed refrigerant pipes, outdoor units and indoor units.  
 \*7 The factory setting of ESP is shown without < > .

# PEAD-M SERIES

STANDARD INVERTER



Type				Inverter Heat Pump									
Indoor Unit				PEAD-M35JAIL2	PEAD-M50JAIL2	PEAD-M60JAIL2	PEAD-M71JAIL2	PEAD-M100JAIL2	PEAD-M100JAIL2	PEAD-M125JAIL2	PEAD-M125JAIL2	PEAD-M140JAIL2	PEAD-M140JAIL2
Outdoor Unit				SUZ-M35VA	SUZ-M50VA	SUZ-M60VA	SUZ-M71VA	PUZ-M100VKA2	PUZ-M100VKA2	PUZ-M125VKA2	PUZ-M125VKA2	PUZ-M140VKA2	PUZ-M140VKA2
Refrigerant(*)				R32									
Power Supply				Outdoor power supply VKA-VHA:230/Single/50, YKA:400/Three/50									
Cooling				Capacity Rated kW 3.6 5.0 6.1 7.1 9.5 9.5 12.1 12.1 13.4 13.4									
Heating				Capacity Rated kW 4.1 6.0 7.0 8.0 11.2 11.2 13.5 13.5 15.0 15.0									
Operating Current(Max)				A 9.7 14.9 16.7 16.7 22.3 13.8 27.8 12.8 31.4 12.9									
Indoor Unit				Input (cooling / Heating) Rated kW 0.05 0.07 0.08 0.09 0.14 0.14 0.20 0.20 0.21 0.21									
Ext.Piping				Diameter(mm) 6.35/9.52 6.35/12.7 6.35/15.88 9.52/15.88 9.52/15.88 9.52/15.88 9.52/15.88 9.52/15.88 9.52/15.88 9.52/15.88									
Guaranteed Operating Range (Outdoor)				Cooling(°C) -10 ~ +46 -15 ~ +46 -15 ~ +46 -15 ~ +46 -15 ~ +46 -15 ~ +46 -15 ~ +46 -15 ~ +46 -15 ~ +46 -15 ~ +46 -15 ~ +46									

\*1 Refrigerant leakage contributes to climate change. Refrigerant with lower global warming potential (GWP) would contribute less to global warming than a refrigerant with higher GWP if leaked to the atmosphere. This appliance contains a refrigerant fluid with a GWP equal to 560. This means that if 1 kg of this refrigerant fluid would be leaked to the atmosphere, the impact on global warming would be 560 times higher than 1 kg of CO<sub>2</sub> over a period of 100 years. Never try to interfere with the refrigerant circuit yourself or disassemble the product yourself and always ask a professional. The GWP of R32 is 675 in the IPCC 4th Assessment Report.  
 \*2 Energy consumption based on standard test results. Actual energy consumption will depend on how the appliance is used and where it is located.  
 \*3 Optional air protection guide is required where ambient temperature is lower than -5°C. \*4 EER/COP and SEER/SCOP for M35-71 are measured at ESP 35Pa, for M100 at ESP 37Pa, for M125/140 at ESP 50Pa.  
 \*5 SEER and SCOP are based on 2009/125/EC/Energy-related Products Directive and Regulation(EU) No206/2012. \*6 Joint pipe is required depending on installed refrigerant pipes, outdoor units and indoor units.  
 \*7 The factory setting of ESP is shown without < > .

# PEA SERIES

The PEA series is a large capacity ceiling-concealed type indoor units which are visually discreet blending into various environments. The PEA model realizes improved energy efficiency with a patented fan called Turbo In Sirocco fan. A wider option of external static pressure up to 250Pa allows authentic ducted air-conditioning with an elegant interior layout. In addition, the PEA series has a separated structure that enables delivery into a narrow space.



PEA-M200/250LA2



The separated structure increases the efficiency of delivery into a narrow space.

## Improved Energy Efficiency

R32 refrigerant with designed fan reduces energy consumption and have resulted in higher energy savings for all capacity ranges.

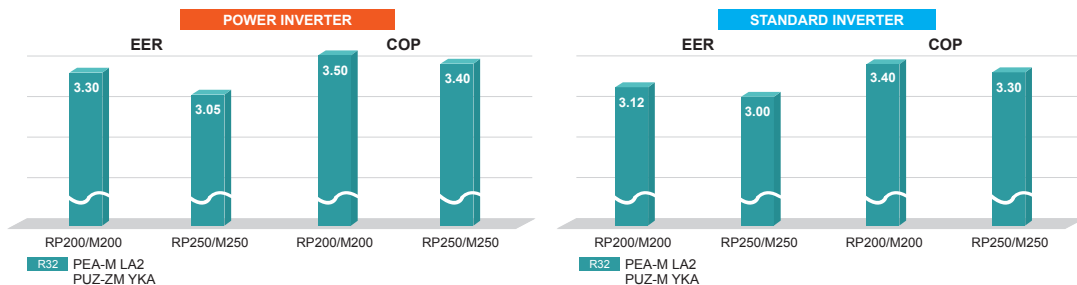

## Low input with Fan Design

The PEA series applies a designed fan; a Turbo In Sirocco fan which realizes high efficiency with a lower power input. The design is Mitsubishi Electric's patented technology with a combination of turbo fan inside the sirocco fan.

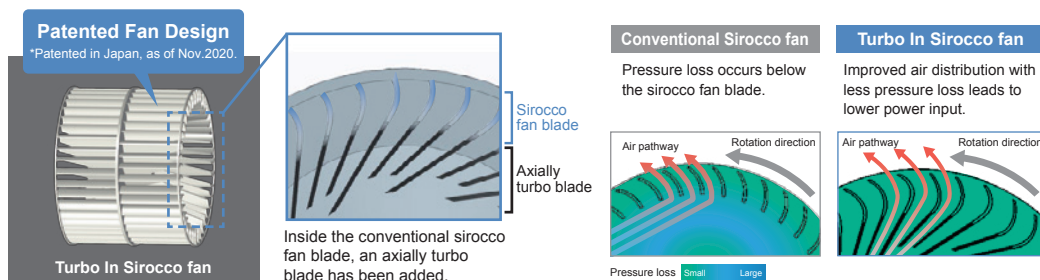

## Wide range of external static pressure allows flexible duct design

250Pa setting is newly added enabling total of five static pressure level. The ability to select additional static pressure enables long duct and more freedom in design.

PEA-M200/250LA2 75/<100>/<150>/<200>/<250> Pa

The factory setting of external static pressure is shown without brackets (<>). Refer to "Fan characteristics curves" according to the external static pressure, in the DATA BOOK for the usable range of airflow rate.

## PAR-41MAA Group Control

The PAR-41MAA remote controller can control up to 16 systems as a group, and is ideal for supporting the integrated management of building air conditioners.

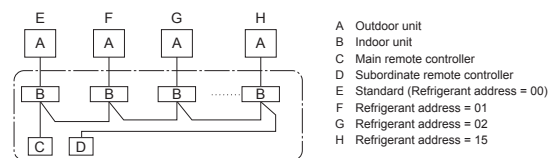

LINE-UP						
<b>Indoor Unit</b>  PEA-M200/250LA2	<b>Outdoor Unit</b> <table border="0"> <tr> <td> <b>Power Inverter Series</b>              PUHZ-ZRP200/250         </td> <td> <b>Standard Inverter Series</b>              PUHZ-P200/250         </td> </tr> <tr> <td> <b>Power Inverter Series</b>              PUZ-ZM200/250         </td> <td> <b>Standard Inverter Series</b>              PUZ-M200/250         </td> </tr> </table>	<b>Power Inverter Series</b>  PUHZ-ZRP200/250	<b>Standard Inverter Series</b>  PUHZ-P200/250	<b>Power Inverter Series</b>  PUZ-ZM200/250	<b>Standard Inverter Series</b>  PUZ-M200/250	<b>Remote Controller</b>  Optional
<b>Power Inverter Series</b>  PUHZ-ZRP200/250	<b>Standard Inverter Series</b>  PUHZ-P200/250					
<b>Power Inverter Series</b>  PUZ-ZM200/250	<b>Standard Inverter Series</b>  PUZ-M200/250					

# PEA-M SERIES

## POWER INVERTER



Type				Inverter Heat Pump			
Indoor Unit				PEA-M200LA2		PEA-M250LA2	
Outdoor Unit				PUZ-M200YKA2		PUZ-M250YKA2	
Refrigerant <sup>(*)</sup>				R32			
Power Supply		Source		Separate power supply			
Cooling		Outdoor(V/Phase/Hz)		400/Three/50			
Cooling	Capacity	Rated	kW	19.0		22.0	
		Min-Max	kW	9.2 - 22.4		9.9 - 27.0	
	Total Input	Rated	kW	5.757		7.213	
	EER			3.30		3.05	
Heating	Capacity	Rated	kW	22.4		27.0	
		Min-Max	kW	7.1 - 25.0		7.3 - 31.0	
	Total Input	Rated	kW	6.400		7.941	
	COP			3.50		3.40	
Operating Current(Max)				A		27.3	
Indoor Unit		Input (cooling / Heating )		Rated		kW	
Operating Current(Max)				A		4.8	
Dimensions		H x W x D		mm		470-1370-1120	
Weight				kg		88	
Air Volume (Lo-Mid-Hi)		Normal airflow mode		m³/min		42.0-51.0-60.0	
		High airflow mode		m³/min		50.0-61.0-72.0 (75Pa-200Pa) 42.0-51.0-60.0 (250Pa)	
External Static Pressure				Pa		75/(100)/(150)/(200)/(250)	
Sound Level (Lo-Mi2-Mi1-Hi) (SPL)				dB(A)		34.5-39.0-43.0	
Sound Level (PWL)				dB(A)		69.0-70.0-70.0	
Dimensions		H x W x D		mm		1338-1050-330(+40)	
Weight				kg		138	
Air Volume		Cooling		m³/min		140	
		Heating		m³/min		140	
Sound Level (SPL)		Cooling		dB(A)		59	
		Heating		dB(A)		62	
Sound Level (PWL)		Cooling		dB(A)		77	
Operating Current(Max)				A		22.5	
Breaker Size				A		32	
Ext.Piping Diameter <sup>(**)</sup>		Liquid/Gas		mm		9.52 / 25.4	
Max.Length		Out-In		m		100	
Max.Height		Out-In		m		30	
Guaranteed Operating Range (Outdoor)		Cooling <sup>(**)</sup>		°C		-15 - 46	
		Heating		°C		-20 - 21	

\*1 Refrigerant leakage contributes to climate change. Refrigerant with lower global warming potential (GWP) would contribute less to global warming than a refrigerant with higher GWP if leaked to the atmosphere. This appliance contains a refrigerant fluid with a GWP equal to 1975. This means that if 1 kg of this refrigerant fluid would be leaked to the atmosphere, the impact on global warming would be 1975 times higher than 1 kg of CO<sub>2</sub> over a period of 100 years. Never try to interfere with the refrigerant circuit yourself or disassemble the product yourself and always ask a professional.  
 \*\*2 Optional air protection guide is required where ambient temperature is lower than -5°C.  
 \*3 Joint pipe is required depending on installed refrigerant pipes, outdoor units and indoor units.

# PEA-M SERIES

## STANDARD INVERTER



Type				Inverter Heat Pump			
Indoor Unit				PEA-M200LA2		PEA-M250LA2	
Outdoor Unit				PUZ-M200YKA2		PUZ-M250YKA2	
Refrigerant <sup>(*)</sup>				R32			
Power Supply		Source		Separate power supply			
Cooling		Outdoor(V/Phase/Hz)		400/Three/50			
Cooling	Capacity	Rated	kW	19.0		22.0	
		Min-Max	kW	9.2 - 22.4		9.9 - 27.0	
	Total Input	Rated	kW	6.089		7.333	
	EER			3.12		3.00	
Heating	Capacity	Rated	kW	22.4		27.0	
		Min-Max	kW	6.8 - 25.0		7.3 - 31.0	
	Total Input	Rated	kW	6.588		8.181	
	COP			3.40		3.30	
Operating Current(Max)				A		27.3	
Indoor Unit		Input (cooling / Heating )		Rated		kW	
Operating Current(Max)				A		4.8	
Dimensions		H x W x D		mm		470-1370-1120	
Weight				kg		88	
Air Volume (Lo-Mid-Hi)		Normal airflow mode		m³/min		42.0-51.0-60.0	
		High airflow mode		m³/min		50.0-61.0-72.0 (75Pa-200Pa) 42.0-51.0-60.0 (250Pa)	
External Static Pressure				Pa		75/(100)/(150)/(200)/(250)	
Sound Level (Lo-Mi2-Mi1-Hi) (SPL)				dB(A)		34.5-39.0-43.0	
Sound Level (PWL)				dB(A)		69.0-70.0-70.0	
Dimensions		H x W x D		mm		1338-1050-330(+40)	
Weight				kg		138	
Air Volume		Cooling		m³/min		140	
		Heating		m³/min		140	
Sound Level (SPL)		Cooling		dB(A)		58	
		Heating		dB(A)		60	
Sound Level (PWL)		Cooling		dB(A)		78	
Operating Current(Max)				A		22.5	
Breaker Size				A		32	
Ext.Piping Diameter <sup>(**)</sup>		Liquid/Gas		mm		9.52 / 25.4	
Max.Length		Out-In		m		70	
Max.Height		Out-In		m		30	
Guaranteed Operating Range (Outdoor)		Cooling <sup>(**)</sup>		°C		-15 - 46	
		Heating		°C		-20 - 21	

\*1 Refrigerant leakage contributes to climate change. Refrigerant with lower global warming potential (GWP) would contribute less to global warming than a refrigerant with higher GWP if leaked to the atmosphere. This appliance contains a refrigerant fluid with a GWP equal to 1975. This means that if 1 kg of this refrigerant fluid would be leaked to the atmosphere, the impact on global warming would be 1975 times higher than 1 kg of CO<sub>2</sub> over a period of 100 years. Never try to interfere with the refrigerant circuit yourself or disassemble the product yourself and always ask a professional.  
 \*\*2 Optional air protection guide is required where ambient temperature is lower than -5°C.  
 \*3 Joint pipe is required depending on installed refrigerant pipes, outdoor units and indoor units.

# PKA SERIES

PKA-M35/50LA(L)2

R32  
R410A



PKA-M60/71/100KA(L)2

R32  
R410A



The compact, wall-mounted indoor units offer the convenience of simple installation, and a large product line-up (M35-M100 models) ensures a best-match solution. Designed for highly efficient energy savings, the PKA Series is the answer to your air conditioning needs.

## New Design (M35-50)

A sharp and simple form that combines beauty and function. The simple square design harmonizes beautifully with the straight lines created by the intersection of the walls, floor and ceiling of the space, leading to a better quality of space. Also adopted a new white body color. It will make your life and space beautiful and comfortable without disturbing the atmosphere of the room. In addition, we realized miniaturization of conventional model. It contributes to space saving of installation area and giving room to room space.



## Quietness (M35-50)

The noise level has been significantly reduced compared to the conventional model by reviewing the unit structure and improving the line flow fan.

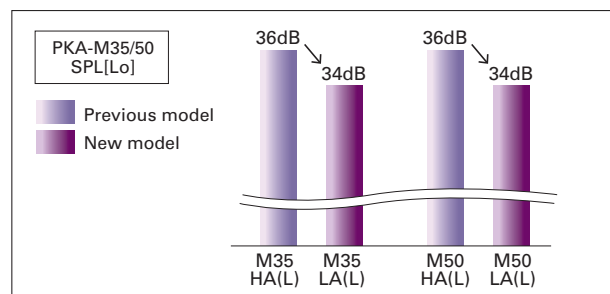

## New Wireless Remote Controller Included

The PKA-KAL2 series wireless remote controller has been updated. It now comes with a new stylish remote controller that fits comfortably in your hand and has a wide range of useful functions.



- Main Functions of new Wireless Remote Controller**
- Weekly Timer
  - Backlight
  - Dual set point
  - Battery replacement sign etc...

## ErP Lot 10 Compliant with High Energy-efficiency Achieving SEER/SCOP Rank A, A+ and A++

Highly efficient indoor unit heat exchangers and newly designed power inverters (PUHZ-ZM) contribute to an amazing reduction in electricity consumption throughout a year, and have resulted in models in the full-capacity range attaining the rank A, A+ and A++ energy savings rating.

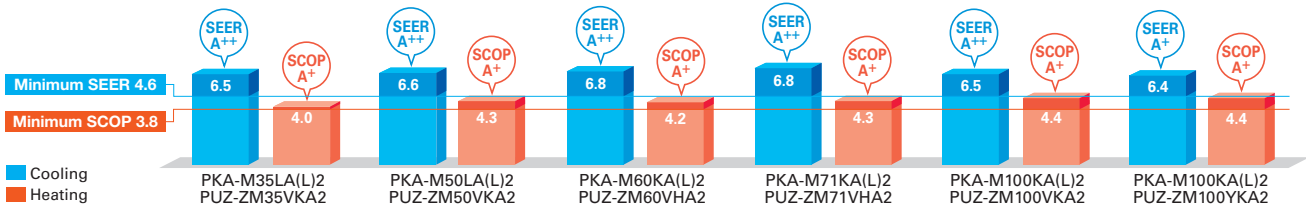

## Airflow Control – Horizontal Airflow – (M35-50)

Significantly improved airflow control to achieve horizontal airflow. This reduces the feeling of draft even on a wall-mounted model, and air conditioning the indoor space firmly.

## Airflow distributions

PKA-M50LA <Cooling mode> Horizontal airflow

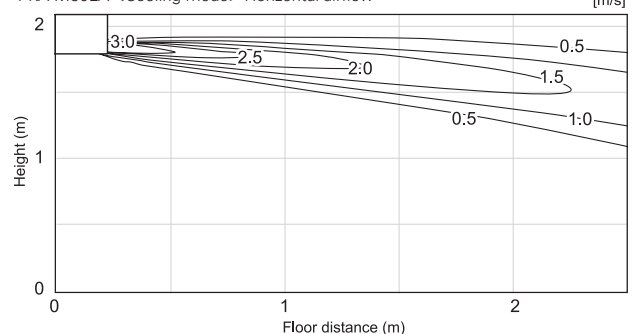

## SERIES SELECTION

### Power Inverter Series



#### Indoor Unit

**R32**  
**R410A**



PKA-M35/50LA(L)2



PKA-M60/71/100KA(L)2

#### Outdoor Unit

**R32**

For Single



PUZ-ZM35/50



PUZ-ZM60/71



PUZ-ZM100/125/140

**R32**

For Multi  
(Twin/Triple/Quadruple)



PUZ-ZM71



PUZ-ZM100/125/140/200/250

#### Remote Controller



Optional (\*)



Optional



Optional (\*)



\*PKA-M•KAL2/LAL2 only

(\*) PAC-SH29TC-E is required for LAL and KAL (optional)

**PKA-M LA(L)2/KA(L)2 Indoor Unit Combinations** Indoor unit combinations shown below are possible.

Indoor Unit Combination	Outdoor Unit Capacity																			
	For Single								For Twin					For Triple			For Quadruple			
	35	50	60	71	100	125	140	200	250	71	100	125	140	200	250	140	200	250	200	250
Power Inverter (PUZ-ZM)	35x1	50x1	60x1	71x1	100x1	-	-	-	-	35x2	50x2	60x2	71x2	100x2	-	50x3	60x3	71x3	50x4	60x4
Distribution Pipe	-	-	-	-	-	-	-	-	-	MSDD-50TR2-E			MSDD-50WR2-E		MSDF-111R3-E			MSDF-1111R2-E		

## SERIES SELECTION

### Standard Inverter Series



#### Indoor Unit

**R32**  
**R410A**

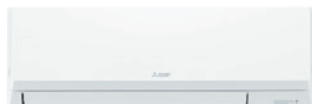

PKA-M35/50LA(L)2



PKA-M60/71/100KA(L)2

#### Outdoor Unit

**R32**

For Single



PUZ-M100

**R32**

For Multi  
(Twin/Triple/Quadruple)



PUZ-M100/125/140



PUZ-M200/250

#### Remote Controller



Optional (\*)



Optional



Optional (\*)



\*PKA-M•KAL2/LAL2 only

(\*) PAC-SH29TC-E is required for LAL and KAL (optional)

**PKA-M LA(L)2/KA(L)2 Indoor Unit Combinations** Indoor unit combinations shown below are possible.

Indoor Unit Combination	Outdoor Unit Capacity																			
	For Single								For Twin					For Triple			For Quadruple			
	35	50	60	71	100	125	140	200	250	71	100	125	140	200	250	140	200	250	200	250
Standard Inverter (PUZ-M)	-	-	-	-	100x1	-	-	-	-	-	50x2	60x2	71x2	100x2	-	50x3	60x3	71x3	50x4	60x4
Distribution Pipe	-	-	-	-	-	-	-	-	-	MSDD-50TR2-E			MSDD-50WR2-E		MSDF-111R3-E			MSDF-1111R2-E		

# PKA-M SERIES

## POWER INVERTER



Type		Inverter Heat Pump								
Indoor Unit		PKA-M35LA(L)2	PKA-M50LA(L)2	PKA-M60KA(L)2	PKA-M71KA(L)2	PKA-M100KA(L)2	PKA-M100KA(L)2			
Outdoor Unit		PUZ-MZ35VKA2	PUZ-MZ50VKA2	PUZ-MZ60VHA2	PUZ-MZ71VHA2	PUZ-MZ100VKA2	PUZ-MZ100VKA2			
Refrigerant <sup>(1)</sup>		R32								
Power Source		Outdoor power supply								
Supply		VKA·VHA:230/Single/50, YKA:400/Three/50								
Cooling	Capacity	Rated	kW	3.6	4.6	6.1	7.1	9.5	9.5	
		Min-Max	kW	1.6 - 4.5	2.3 - 5.6	2.7 - 6.7	3.3 - 8.1	4.9 - 11.4	4.9 - 11.4	
	Total Input	Rated	kW	0.857	1.239	1.560	1.863	2.435	2.435	
	EER			4.20	3.71	3.91	3.81	3.90	3.90	
	Design load		kW	3.6	4.6	6.1	7.1	9.5	9.5	
	Annual electricity consumption <sup>(2)</sup>		kWh/a	194	244	314	365	508	519	
	SEER <sup>(4)</sup>		6.5	6.6	6.8	6.8	6.5	6.4		
		Energy efficiency class		A++	A++	A++	A++	A++	A++	
Heating	Capacity	Rated	kW	4.1	5.0	7.0	8.0	11.2	11.2	
		Min-Max	kW	1.6 - 5.2	2.5 - 7.0	2.8 - 8.2	3.5 - 10.2	4.5 - 14.0	4.5 - 14.0	
	Total Input	Rated	kW	1.040	1.344	1.732	2.116	3.102	3.102	
	COP			3.94	3.72	4.04	3.78	3.61	3.61	
	Design load		kW	2.4	3.3	4.4	4.7	7.8	7.8	
	Declared Capacity		at reference design temperature	kW	2.4 (-10°C)	3.3 (-10°C)	4.4 (-10°C)	4.7 (-10°C)	7.8 (-10°C)	7.8 (-10°C)
			at bivalent temperature	kW	2.4 (-10°C)	3.3 (-10°C)	4.4 (-10°C)	4.7 (-10°C)	7.8 (-10°C)	7.8 (-10°C)
			at operation limit temperature	kW	2.2 (-11°C)	3.2 (-11°C)	2.8 (-20°C)	3.4 (-20°C)	5.8 (-20°C)	5.8 (-20°C)
	Back up heating capacity		kW	0.0	0.0	0.0	0.0	0.0	0.0	
	Annual electricity consumption <sup>(2)</sup>		kWh/a	829	1074	1464	1530	2477	2478	
	SCOP <sup>(4)</sup>		4.0	4.3	4.2	4.3	4.4	4.4		
		Energy efficiency class		A+	A+	A+	A+	A+	A+	
Operating Current(Max)		A		13.4	13.4	19.4	19.4	20.6	8.6	
Indoor Unit	Input [cooling / Heating]	Rated	kW	0.04 / 0.03	0.04 / 0.03	0.06 / 0.05	0.06 / 0.05	0.08 / 0.07	0.08 / 0.07	
	Operating Current(Max)		A	0.35	0.35	0.43	0.43	0.57	0.57	
	Dimensions	H*W*D	mm	299-898-237	299-898-237	365-1170-295	365-1170-295	365-1170-295	365-1170-295	
	Weight		kg	12.6	12.6	21	21	21	21	
	Air Volume (Lo-Mi2-Mi1-Hi)		m³/min	7.5-8.2-9.2-10.9	7.5-8.2-9.2-10.9	18-20-22	18-20-22	20-23-26	20-23-26	
	Sound Level (Lo-Mi2-Mi1-Hi) (SPL)		dB(A)	34-37-40-43	34-37-40-43	39-42-45	39-42-45	41-45-49	41-45-49	
	Sound Level (PWL)		dB(A)	60	60	64	64	65	65	
	Outdoor Unit	Dimensions	H*W*D	mm	630-809-300	630-809-300	943-950-330(+25)	943-950-330(+25)	1338-1050-330(+40)	1338-1050-330(+40)
		Weight		kg	46	46	67	67	105	111
		Air Volume	Cooling	m³/min	45	45	55	55	110	110
Heating			m³/min	45	45	55	55	110	110	
Sound Level (SPL)		Cooling	dB(A)	44	44	47	47	49	49	
		Heating	dB(A)	46	46	49	49	51	51	
Sound Level (PWL)	Cooling	dB(A)	65	65	67	67	69	69		
Operating Current(Max)		A	13	13	19	19	20	8		
Breaker Size		A	16	16	25	25	32	16		
Ext.Piping	Diameter <sup>(3)</sup>	Liquid/Gas	mm	6.35 / 12.7	6.35 / 12.7	9.52 / 15.88	9.52 / 15.88	9.52 / 15.88	9.52 / 15.88	
	Max.Length	Out-In	m	50	50	55	55	100	100	
	Max.Height	Out-In	m	30	30	30	30	30	30	
Guaranteed Operating Range (Outdoor)	Cooling <sup>(3)</sup>	°C	-15 ~ +46	-15 ~ +46	-15 ~ +46	-15 ~ +46	-15 ~ +46	-15 ~ +46	-15 ~ +46	
	Heating	°C	-11 ~ +21	-11 ~ +21	-20 ~ +21	-20 ~ +21	-20 ~ +21	-20 ~ +21		

\*1 Refrigerant leakage contributes to climate change. Refrigerant with lower global warming potential (GWP) would contribute less to global warming than a refrigerant with higher GWP if leaked to the atmosphere. This appliance contains a refrigerant fluid with a GWP equal to 550. This means that if 1 kg of this refrigerant fluid would be leaked to the atmosphere, the impact on global warming would be 550 times higher than 1 kg of CO<sub>2</sub> over a period of 100 years. Never try to interfere with the refrigerant circuit yourself or disassemble the product yourself and always ask a professional. The GWP of R32 is 675 in the IPCC 4th Assessment Report.  
 \*2 Energy consumption based on standard test results. Actual energy consumption will depend on how the appliance is used and where it is located.  
 \*3 Optional air protection guide is required where ambient temperature is lower than -5°C. \*4 SEER and SCOP are based on 2009/125/EC:Energy-related Products Directive and Regulation(EU) No206/2012.  
 \*5 Joint pipe is required depending on installed refrigerant pipes, outdoor units and indoor units.

# PKA-M SERIES

## STANDARD INVERTER



Type		Inverter Heat Pump							
Indoor Unit		PKA-M100KA(L)2							
Outdoor Unit		PUZ-M100VKA2			PUZ-M100YKA2				
Refrigerant <sup>(1)</sup>		R32							
Power Source		Outdoor power supply							
Supply		VKA·VHA:230/Single/50, YKA:400/Three/50							
Cooling	Capacity	Rated	kW	9.5			9.5		
		Min-Max	kW	4.0 - 10.6			4.0 - 10.6		
	Total Input	Rated	kW	2.941			2.941		
	EER			3.23			3.23		
	Design load		kW	9.5			9.5		
	Annual electricity consumption <sup>(2)</sup>		kWh/a	573			573		
	SEER <sup>(4)</sup>		5.8			5.8			
		Energy efficiency class		A+			A+		
Heating	Capacity	Rated	kW	11.2			11.2		
		Min-Max	kW	2.8 - 12.5			2.8 - 12.5		
	Total Input	Rated	kW	3.284			3.284		
	COP			3.41			3.41		
	Design load		kW	8.0			8.0		
	Declared Capacity		at reference design temperature	kW	6.0 (-10°C)			6.0 (-10°C)	
			at bivalent temperature	kW	7.0 (-7°C)			7.0 (-7°C)	
			at operation limit temperature	kW	4.5 (-15°C)			4.5 (-15°C)	
	Back up heating capacity		kW	2.0			2.0		
	Annual electricity consumption <sup>(2)</sup>		kWh/a	2780			2780		
	SCOP <sup>(4)</sup>		4.0			4.0			
		Energy efficiency class		A+			A+		
Operating Current(Max)		A		20.6			12.1		
Indoor Unit	Input [cooling / Heating]	Rated	kW	0.08 / 0.07			0.08 / 0.07		
	Operating Current(Max)		A	0.57			0.57		
	Dimensions	H*W*D	mm	365-1170-295			365-1170-295		
	Weight		kg	21			21		
	Air Volume (Lo-Mi2-Mi1-Hi)		m³/min	20-23-26			20-23-26		
	Sound Level (Lo-Mi2-Mi1-Hi) (SPL)		dB(A)	41-45-49			41-45-49		
	Sound Level (PWL)		dB(A)	65			65		
	Outdoor Unit	Dimensions	H*W*D	mm	981-1050-330 (+40)			981-1050-330(+40)	
		Weight		kg	76			78	
		Air Volume	Cooling	m³/min	79			79	
Heating			m³/min	79			79		
Sound Level (SPL)		Cooling	dB(A)	51			51		
		Heating	dB(A)	54			54		
Sound Level (PWL)	Cooling	dB(A)	70			70			
Operating Current(Max)		A	20.0			11.5			
Breaker Size		A	32			16			
Ext.Piping	Diameter <sup>(3)</sup>	Liquid/Gas	mm	9.52 / 15.88			9.52 / 15.88		
	Max.Length	Out-In	m	55			55		
	Max.Height	Out-In	m	30			30		
Guaranteed Operating Range (Outdoor)	Cooling <sup>(3)</sup>	°C	-15 ~ +46			-15 ~ +46			
	Heating	°C	-15 ~ +21			-15 ~ +21			

\*1 Refrigerant leakage contributes to climate change. Refrigerant with lower global warming potential (GWP) would contribute less to global warming than a refrigerant with higher GWP if leaked to the atmosphere. This appliance contains a refrigerant fluid with a GWP equal to 550. This means that if 1 kg of this refrigerant fluid would be leaked to the atmosphere, the impact on global warming would be 550 times higher than 1 kg of CO<sub>2</sub> over a period of 100 years. Never try to interfere with the refrigerant circuit yourself or disassemble the product yourself and always ask a professional. The GWP of R32 is 675 in the IPCC 4th Assessment Report.  
 \*2 Energy consumption based on standard test results. Actual energy consumption will depend on how the appliance is used and where it is located.  
 \*3 Optional air protection guide is required where ambient temperature is lower than -5°C. \*4 SEER and SCOP are based on 2009/125/EC:Energy-related Products Directive and Regulation(EU) No206/2012. \*5 Joint pipe is required depending on installed refrigerant pipes, outdoor units and indoor units.

# PCA-KA SERIES



PCA-M35/50/60/71/100/125/140KA2



A stylish new indoor unit design and airflow settings for both high- and low-ceiling interiors expand installation possibilities. Together with exceptional energy-saving performance, these units are the solution to diversified air conditioning needs.

## Stylish Indoor Unit Design

A stylish square-like design is adopted for the indoor units of all models. As a result, the units blend in better with the ceiling.



PCA-KA

## ErP Lot 10 Compliant with High Energy-efficiency Achieving SEER/SCOP Rank A, A+ and A++

A direct-current (DC) fan motor is installed in the indoor unit, increasing the seasonal energy efficiency of newly designed Power Inverter series (PUHZ-ZM) and resulting in the full capacity models comply ErP Lot 10 with energy ranking A+/A++ for cooling and A/A+ for heating. This contribute to an impressive reduction in the cost of annual electricity.

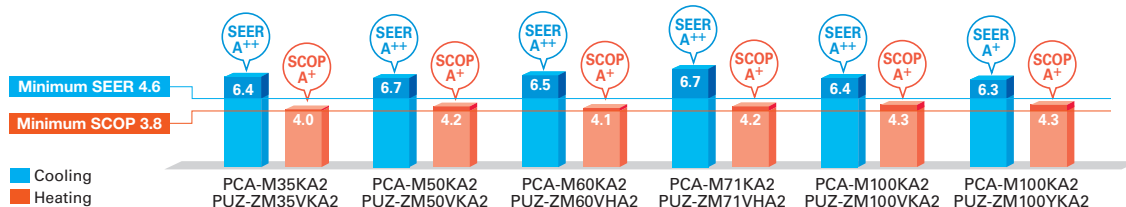

## Optional Drain Pump for Full-capacity Models

The pumping height of the optional drain pump has been increased from 400mm to 600mm, expanding flexibility in choosing unit location during installation work.

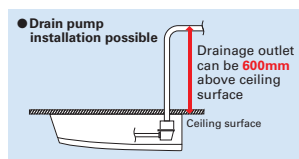

## Outside-air Intake

Units are equipped with a knock-out hole that enables the induction of fresh outside-air.

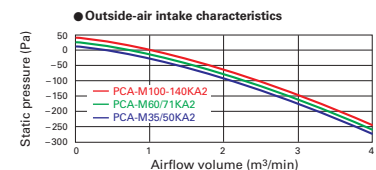

## Equipped with Automatic Air-speed Adjustment

In addition to the conventional 4-speed setting, units are now equipped with an automatic air-speed adjustment mode. This setting automatically adjusts the air-speed to conditions that match the room environment. At the start of heating/cooling operation, the airflow is set to high-speed to quickly heat/cool the room. When the room temperature reaches the desired setting, the airflow speed is decreased automatically for stable comfortable heating/cooling operation.

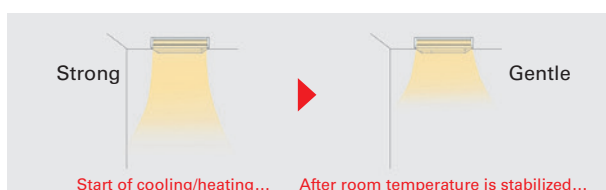

## Equipped with High- /Low-ceiling Modes

Units are equipped with high- and low-ceiling operation modes that make it possible to switch the airflow volume to match room height. The ability to choose the optimum airflow volume makes it possible to optimize the breezy sensation felt throughout the room.

Capacity	High ceiling	Standard ceiling	Low ceiling
35	3.5m	2.7m	2.5m
50	3.5m	2.7m	2.5m
60	3.5m	2.7m	2.5m
71	3.5m	2.7m	2.5m
100	4.2m	3.0m	2.6m
125	4.2m	3.0m	2.6m
140	4.2m	3.0m	2.6m



## SERIES SELECTION

### Power Inverter Series



#### Indoor Unit

**R32**  
**R410A**



PCA-M35/50/60/71/100/125/140KA2

#### Outdoor Unit

**R32**

For Single



PUZ-ZM35/50    PUZ-ZM60/71    PUZ-ZM100/125/140

**R32**

For Multi  
(Twin/Triple/Quadruple)



PUZ-ZM71    PUZ-ZM100/125/140/200/250

#### Remote Controller



Optional    Optional    Optional    Optional    Optional\*

\* PAR-SA9CA is also required.

### PCA-M Indoor Unit Combinations

Indoor unit combinations shown below are possible.

Indoor Unit Combination	Outdoor Unit Capacity																			
	For Single									For Twin						For Triple			For Quadruple	
	35	50	60	71	100	125	140	200	250	71	100	125	140	200	250	140	200	250	200	250
Power Inverter (PUZ-ZM)	35x1	50x1	60x1	71x1	100x1	125x1	140x1	-	-	35x2	50x2	60x2	71x2	100x2	125x2	50x3	60x3	71x3	50x4	60x4
Distribution Pipe	-	-	-	-	-	-	-	-	-	MSDD-50TR2-E			MSDD-50WR2-E			MSDT-111R3-E			MSDF-111R2-E	

## SERIES SELECTION

### Standard Inverter Series



#### Indoor Unit

**R32**  
**R410A**



PCA-M35/50/60/71/100/125/140KA2

#### Outdoor Unit

**R32**

For Single



SUZ-M35    SUZ-M50    SUZ-M60/71    PUZ-M100/125/140

**R32**

For Multi  
(Twin/Triple/Quadruple)



PUZ-M100/125/140    PUZ-M200/250

#### Remote Controller



Optional    Optional    Optional    Optional    Optional\*

\* PAR-SA9CA is also required.

### PCA-M Indoor Unit Combinations

Indoor unit combinations shown below are possible.

Indoor Unit Combination	Outdoor Unit Capacity																			
	For Single									For Twin						For Triple			For Quadruple	
	35	50	60	71	100	125	140	200	250	71	100	125	140	200	250	140	200	250	200	250
Standard Inverter (PUZ-M&SUZ)	35x1	50x1	60x1	71x1	100x1	125x1	140x1	-	-	-	50x2	60x2	71x2	100x2	125x2	50x3	60x3	71x3	50x4	60x4
Distribution Pipe	-	-	-	-	-	-	-	-	-	MSDD-50TR2-E			MSDD-50WR2-E			MSDT-111R3-E			MSDF-111R2-E	

# PCA-M KA SERIES

## POWER INVERTER



Type	Inverter Heat Pump												
Indoor Unit	PCA-M35KA2	PCA-M50KA2	PCA-M60KA2	PCA-M71KA2	PCA-M100KA2	PCA-M100KA2	PCA-M125KA2	PCA-M125KA2	PCA-M140KA2	PCA-M140KA2	PCA-M140KA2	PCA-M140KA2	
Outdoor Unit	PUZ-ZM35VKA2	PUZ-ZM50VKA2	PUZ-ZM60VHA2	PUZ-ZM71VHA2	PUZ-ZM100VKA2	PUZ-ZM100VKA2	PUZ-ZM125VKA2	PUZ-ZM125VKA2	PUZ-ZM140VKA2	PUZ-ZM140VKA2	PUZ-ZM140VKA2	PUZ-ZM140VKA2	
Refrigerant <sup>(1)</sup>	R32												
Power Supply	Outdoor power supply VKA-VHA:230/Single/50, YKA:400/Three/50												
Cooling	Capacity	Rated	kW										
	Min-Max	Rated	kW										
	Total Input	Rated	kW										
	EER	Rated	kW										
	Design load	Rated	kW										
Heating	Capacity	Rated	kW										
	Min-Max	Rated	kW										
	Total Input	Rated	kW										
	EER	Rated	kW										
	Design load	Rated	kW										
Annual electricity consumption <sup>(2)</sup>	Annual electricity consumption <sup>(2)</sup>	Rated	kWh/a										
	SEER <sup>(4)</sup>	Rated	kWh/a										
Energy efficiency class	Energy efficiency class	Rated	A++										
	Energy efficiency class	Rated	A++										
Operating Current(Max)	Operating Current(Max)	Rated	A										
	Operating Current(Max)	Rated	A										
Indoor Unit	Input [cooling / Heating]	Rated	kW										
	Operating Current(Max)	Rated	A										
Dimensions	Dimensions	H*W*D	mm										
	Weight	kg	kg										
Air Volume	Air Volume (Lo-Mi2-Mi1-Hi)	m³/min	m³/min										
	Sound Level (Lo-Mi2-Mi1-Hi) (SPL)	dB(A)	dB(A)										
Sound Level (PWL)	Sound Level (PWL)	dB(A)	dB(A)										
	Sound Level (PWL)	dB(A)	dB(A)										
Outdoor Unit	Dimensions	H*W*D	mm										
	Weight	kg	kg										
Air Volume	Air Volume	m³/min	m³/min										
	Sound Level (SPL)	dB(A)	dB(A)										
Sound Level (PWL)	Sound Level (PWL)	dB(A)	dB(A)										
	Sound Level (PWL)	dB(A)	dB(A)										
Operating Current(Max)	Operating Current(Max)	A	A										
	Breaker Size	A	A										
Ext.Piping	Diameter <sup>(3)</sup>	Liquid/Gas	mm										
	Max.Length	Out-In	m										
Guaranteed Operating Range (Outdoor)	Cooling <sup>(3)</sup>	°C	°C										
	Heating	°C	°C										

\*1 Refrigerant leakage contributes to climate change. Refrigerant with lower global warming potential (GWP) would contribute less to global warming than a refrigerant with higher GWP, if leaked to the atmosphere. This appliance contains a refrigerant fluid with a GWP equal to 550. This means that if 1 kg of this refrigerant fluid would be leaked to the atmosphere, the impact on global warming would be 550 times higher than 1 kg of CO<sub>2</sub>, over a period of 100 years. Never try to interfere with the refrigerant circuit yourself or disassemble the product yourself and always ask a professional. The GWP of R32 is 675 in the IPCC 4th Assessment Report.  
\*2 Energy consumption based on standard test results. Actual energy consumption will depend on how the appliance is used and where it is located.  
\*3 Optional air protection guide is required where ambient temperature is lower than -5°C.  
\*4 SEER and SCOP are based on 2009/125/EC:Energy-related Products Directive and Regulation(EU) No206/2012.  
\*5 Joint pipe is required depending on installed refrigerant pipes, outdoor units and indoor units.

# PCA-M KA SERIES

## STANDARD INVERTER



Type	Inverter Heat Pump												
Indoor Unit	PCA-M35KA2	PCA-M50KA2	PCA-M60KA2	PCA-M71KA2	PCA-M100KA2	PCA-M100KA2	PCA-M125KA2	PCA-M125KA2	PCA-M140KA2	PCA-M140KA2	PCA-M140KA2	PCA-M140KA2	
Outdoor Unit	SUZ-ZM35VA	SUZ-ZM50VA	SUZ-ZM60VA	SUZ-ZM71VA	PUZ-M100VKA2	PUZ-M100VKA2	PUZ-M125VKA2	PUZ-M125VKA2	PUZ-M140VKA2	PUZ-M140VKA2	PUZ-M140VKA2	PUZ-M140VKA2	
Refrigerant <sup>(1)</sup>	R32												
Power Supply	Outdoor power supply VA-VKA:230/Single/50, YKA:400/Three/50												
Cooling	Capacity	Rated	kW										
	Min-Max	Rated	kW										
	Total Input	Rated	kW										
	EER	Rated	kW										
	Design load	Rated	kW										
Heating	Capacity	Rated	kW										
	Min-Max	Rated	kW										
	Total Input	Rated	kW										
	EER	Rated	kW										
	Design load	Rated	kW										
Annual electricity consumption <sup>(2)</sup>	Annual electricity consumption <sup>(2)</sup>	Rated	kWh/a										
	SEER <sup>(4)</sup>	Rated	kWh/a										
Energy efficiency class	Energy efficiency class	Rated	A++										
	Energy efficiency class	Rated	A++										
Operating Current(Max)	Operating Current(Max)	Rated	A										
	Operating Current(Max)	Rated	A										
Indoor Unit	Input [cooling / Heating]	Rated	kW										
	Operating Current(Max)	Rated	A										
Dimensions	Dimensions	H*W*D	mm										
	Weight	kg	kg										
Air Volume	Air Volume (Lo-Mi2-Mi1-Hi)	m³/min	m³/min										
	Sound Level (Lo-Mi2-Mi1-Hi) (SPL)	dB(A)	dB(A)										
Sound Level (PWL)	Sound Level (PWL)	dB(A)	dB(A)										
	Sound Level (PWL)	dB(A)	dB(A)										
Outdoor Unit	Dimensions	H*W*D	mm										
	Weight	kg	kg										
Air Volume	Air Volume	m³/min	m³/min										
	Sound Level (SPL)	dB(A)	dB(A)										
Sound Level (PWL)	Sound Level (PWL)	dB(A)	dB(A)										
	Sound Level (PWL)	dB(A)	dB(A)										
Operating Current(Max)	Operating Current(Max)	A	A										
	Breaker Size	A	A										
Ext.Piping	Diameter <sup>(3)</sup>	Liquid/Gas	mm										
	Max.Length	Out-In	m										
Guaranteed Operating Range (Outdoor)	Cooling <sup>(3)</sup>	°C	°C										
	Heating	°C	°C										

\*1 Refrigerant leakage contributes to climate change. Refrigerant with lower global warming potential (GWP) would contribute less to global warming than a refrigerant with higher GWP, if leaked to the atmosphere. This appliance contains a refrigerant fluid with a GWP equal to 550. This means that if 1 kg of this refrigerant fluid would be leaked to the atmosphere, the impact on global warming would be 550 times higher than 1 kg of CO<sub>2</sub>, over a period of 100 years. Never try to interfere with the refrigerant circuit yourself or disassemble the product yourself and always ask a professional. The GWP of R32 is 675 in the IPCC 4th Assessment Report.  
\*2 Energy consumption based on standard test results. Actual energy consumption will depend on how the appliance is used and where it is located.  
\*3 Optional air protection guide is required where ambient temperature is lower than -5°C.  
\*4 SEER and SCOP are based on 2009/125/EC:Energy-related Products Directive and Regulation(EU) No206/2012.  
\*5 Joint pipe is required depending on installed refrigerant pipes, outdoor units and indoor units.

R32  
R410A

# PCA-HA SERIES

PCA-M71HA2



Standard features include a strong carbon-black stainless steel body and built-in oil mist filter to prevent oil from getting into the unit providing a comfortable air conditioning environment in kitchens that use open-flame cooking.

## Tough on Oily Smoke

A durable stainless steel casing that is resistant to oil and grease is provided to protect the surface of the body. Grimy dirt and stains are removed easily, enabling the unit to be kept clean at all times.

## High-performance Oil Mist Filter

A high-performance heavy-duty oil mist filter is included as standard equipment. The filtering system is more efficient than conventional filters, thereby effectively reducing the oily smoke entering the air conditioner. The filter is disposable, thereby enabling trouble-free cleaning and maintenance.

### Oil Mist Filter Cleaning

When used in kitchens, the oil mist filter should be replaced once every two months. The system comes with 12 filter elements. After these have been used, optional elements (PAC-SG38KF-E) can be purchased.

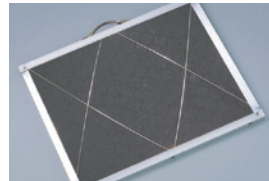

Oil mist filter

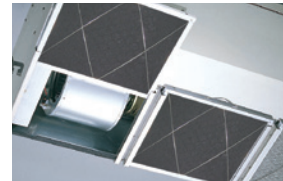

Pull the handle to easily slide the filter out

## Easy Maintenance – Even for Cleaning the Fan

A separate fan casing that can be disassembled in sections is adopted to ensure easy fan cleaning. Drain pan cleaning onsite is also no problem owing to the use of a pipe connector that is easily removed.

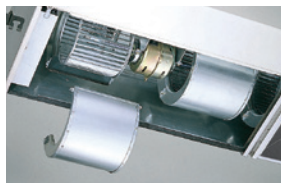

## Cosmetic Front and Hanging Fixture Covers (Option)

Cosmetic covers are available to prevent the collection of dust and grime on the main body and hanging fixture sections.

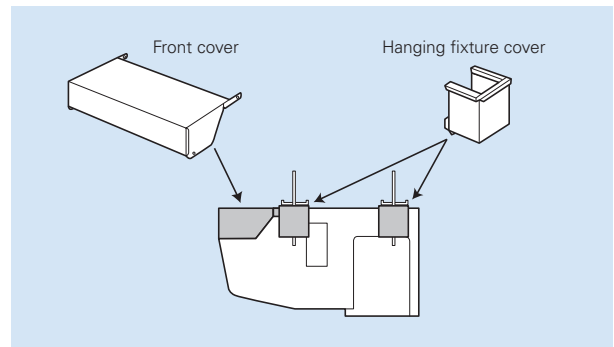

## Fresh Outside-air Intake (Option)

There is a knock-out opening on the rear panel of the unit that can be used to bring fresh air into the unit. This helps to improve ventilation and make the kitchen comfortable.

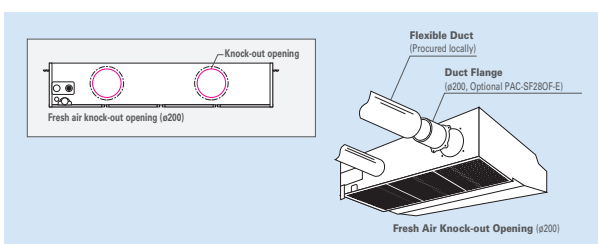

- Notes: 1) A fresh-air duct flange is required (sold separately)  
2) Intake air is not 100% fresh (outside) air.

## SERIES SELECTION

### Power Inverter Series



#### Indoor Unit

**R32**  
**R410A**



PCA-M71HA2

#### Outdoor Unit

**R32**

For Single



PUZ-ZM71

**R32**

For Multi  
(Twin/Triple)



PUZ-ZM140/250

#### Remote Controller



Optional



Optional



Optional



Optional\*

\* PAR-SA9CA is also required.

**PCA-M HA Indoor Unit Combinations** Indoor unit combinations shown below are possible.

Indoor Unit Combination	Outdoor Unit Capacity																				
	For Single									For Twin					For Triple			For Quadruple			
	35	50	60	71	100	125	140	200	250	71	100	125	140	200	250	140	200	250	200	250	
Power Inverter (PUZ-ZM)	-	-	-	71x1	-	-	-	-	-	-	-	-	71x2	-	-	-	-	-	71x3	-	-
Distribution Pipe	-	-	-	-	-	-	-	-	-	-	-	-	MSDD-50TR2-E	-	-	-	-	-	MSDF-111R3-E	-	-

## SERIES SELECTION

### Power Inverter Series



#### Indoor Unit

**R32**  
**R410A**



PCA-M71HA2

#### Outdoor Unit

For Single



PUHZ-ZRP71

For Multi  
(Twin/Triple)



PUHZ-ZRP140/250

#### Remote Controller



Optional



Optional



Optional

Optional\*

\* PAR-SA9CA is also required.

**PCA-M HA Indoor Unit Combinations** Indoor unit combinations shown below are possible.

Indoor Unit Combination	Outdoor Unit Capacity																				
	For Single									For Twin					For Triple			For Quadruple			
	35	50	60	71	100	125	140	200	250	71	100	125	140	200	250	140	200	250	200	250	
Power Inverter (PUHZ-ZRP)	-	-	-	71x1	-	-	-	-	-	-	-	-	71x2	-	-	-	-	-	71x3	-	-
Distribution Pipe	-	-	-	-	-	-	-	-	-	-	-	-	MSDD-50TR-E	-	-	-	-	-	MSDF-111R-E	-	-

# PCA-M HA SERIES

## POWER INVERTER

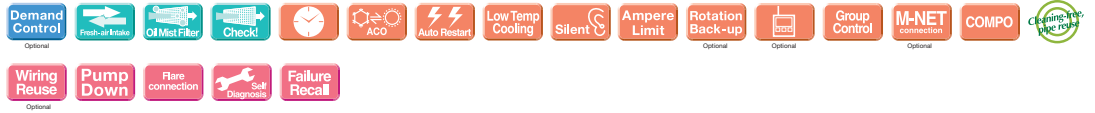

Type		Inverter Heat Pump		
Indoor Unit		PCA-M71HA2		
Outdoor Unit		PUZ-ZM71VHA2		
Refrigerant <sup>(*)</sup>		R32		
<b>Power Supply</b>	<b>Source</b>	Outdoor power supply		
<b>Outdoor(V/Phase/Hz)</b>		230/Single/50		
<b>Cooling</b>	<b>Capacity</b>	Rated	kW	
		Min-Max	7.1	
	<b>Total Input</b>	Rated	kW	
			3.3 - 8.1	
	<b>EER</b>			
			2.028	
<b>Heating</b>	<b>Design load</b>		kW	
			7.1	
	<b>Annual electricity consumption<sup>(**)</sup></b>		kWh/a	
			443	
	<b>SEER<sup>(**)</sup></b>			
			5.6	
	<b>Energy efficiency class</b>			A+
	<b>Capacity</b>	Rated	kW	
		Min-Max	kW	
			7.6	
<b>Total Input</b>	Rated	kW		
		3.5 - 10.2		
<b>COP</b>				
		2.171		
<b>Design load</b>		kW		
		3.50		
<b>Declared Capacity</b>	at reference design temperature	kW		
	at bivalent temperature	kW		
	at operation limit temperature	kW		
		4.7		
		4.7 (-10°C)		
		4.7 (-10°C)		
		3.4 (-20°C)		
<b>Back up heating capacity</b>		kW		
		0.0		
<b>Annual electricity consumption<sup>(**)</sup></b>		kWh/a		
		1684		
<b>SCOP<sup>(**)</sup></b>				
		3.9		
<b>Energy efficiency class</b>			A	
<b>Operating Current(Max)</b>		A		
		19.4		
<b>Indoor Unit</b>	<b>Input [cooling / Heating ]</b>	Rated	kW	
			0.10 / 0.10	
	<b>Operating Current(Max)</b>		A	
			0.43	
	<b>Dimensions</b>	H*W*D	mm	
			280-1136-650	
	<b>Weight</b>		kg	
		42		
<b>Air Volume (Lo-Mi2-Mi1-Hi)</b>		m <sup>3</sup> /min		
		16-18		
<b>Sound Level (Lo-Mi2-Mi1-Hi) (SPL)</b>		dB(A)		
		37-39		
<b>Sound Level (PWL)</b>		dB(A)		
		57		
<b>Outdoor Unit</b>	<b>Dimensions</b>	H*W*D	mm	
			943-950-330(+25)	
	<b>Weight</b>		kg	
			67	
	<b>Air Volume</b>	Cooling	m <sup>3</sup> /min	
		Heating	m <sup>3</sup> /min	
			55	
	<b>Sound Level (SPL)</b>	Cooling	dB(A)	
		Heating	dB(A)	
			47	
<b>Sound Level (PWL)</b>	Cooling	dB(A)		
	Heating	dB(A)		
		49		
<b>Operating Current(Max)</b>		A		
		19		
<b>Breaker Size</b>		A		
		25		
<b>Ext.Piping</b>	<b>Diameter<sup>(**)</sup></b>	Liquid/Gas	mm	
			9.52 / 15.88	
	<b>Max.Length</b>	Out-In	m	
		55		
<b>Max.Height</b>	Out-In	m		
		30		
<b>Guaranteed Operating Range (Outdoor)</b>	Cooling <sup>(**)</sup>	°C		
		-15 ~ +46		
	Heating	°C		
		-20 ~ +21		

\*1 Refrigerant leakage contributes to climate change. Refrigerant with lower global warming potential (GWP) would contribute less to global warming than a refrigerant with higher GWP, if leaked to the atmosphere. This appliance contains a refrigerant fluid with a GWP equal to 1975. This means that if 1 kg of this refrigerant fluid would be leaked to the atmosphere, the impact on global warming would be 1975 times higher than 1 kg of CO<sub>2</sub> over a period of 100 years. Never try to interfere with the refrigerant circuit yourself or disassemble the product yourself and always ask a professional. The GWP of R410A is 2088 in the IPCC 4th Assessment Report.

\*2 Energy consumption based on standard test results. Actual energy consumption will depend on how the appliance is used and where it is located.

\*3 Optional air protection guide is required where ambient temperature is lower than -5°C.

\*4 SEER and SCOP are based on 2009/125/EC:Energy-related Products Directive and Regulation(EU) No206/2012.

\*5 Joint pipe is required depending on installed refrigerant pipes, outdoor units and indoor units.

# PSA SERIES

R32  
R410A

PSA-M71/100/125/140KA



Installation of this floor-standing series is easy and quick.  
An excellent choice when there is a sudden need for an air conditioner to be installed.

## A slim design that fits neatly into any space

With a width of only 600mm, this slim unit can fit neatly into narrow spaces.



## Built-in MA smart remote controller

The large and easy-to-read LCD makes it easy to perform a variety of functions.



## Equipped with a long-life filter as standard

The adoption of a grille that can be opened allows the filter to be easily removed.

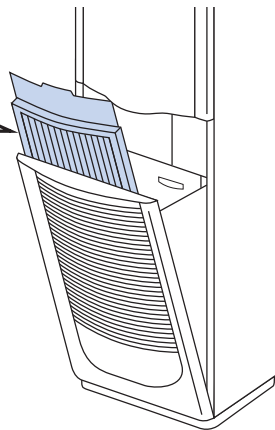

## A wide airflow range with horizontal swinging

The horizontal swinging function can be turned on or off via the remote controller to deliver comfort over a wider area.

Automatic swinging in the horizontal direction

The horizontal-swinging louvers provide wide coverage for improved comfort.

Airflow can also be adjusted manually in the vertical direction.

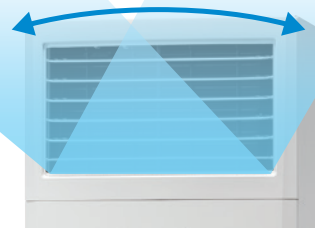

## Floor-standing Line-up

The PSA series was previously only able to be connected to P series outdoor units. However, it can now also be connected to S series outdoor units. This wider lineup provides our customers with a more flexible range of options.

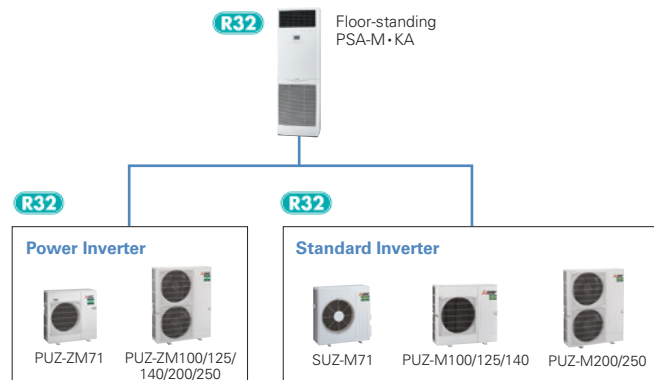

## SERIES SELECTION

### Power Inverter Series



#### Indoor Unit

**R32**  
**R410A**



PSA-M71/100/125/140KA

#### Outdoor Unit

**R32**

For Single



PUZ-ZM71



PUZ-ZM100/125/140

**R32**

For Multi  
(Twin/Triple)



PUZ-ZM140/200/250

#### Remote Controller



Built-in



Optional\*

\* PAR-SA9CA-E is also required.

### PSA-M Indoor Unit Combinations Indoor unit combinations shown below are possible.

Indoor Unit Combination	Outdoor Unit Capacity																			
	For Single									For Twin					For Triple			For Quadruple		
	35	50	60	71	100	125	140	200	250	71	100	125	140	200	250	140	200	250	200	250
Power Inverter (PUZ-ZM)	-	-	-	71x1	100x1	125x1	140x1	-	-	-	-	-	71x2	100x2	125x2	-	-	71x3	-	-
Distribution Pipe	-	-	-	-	-	-	-	-	-	-	-	-	MSDD-50TR2-E	MSDD-50WR2-E	-	-	MSDT-111R3-E	-	-	

## SERIES SELECTION

### Standard Inverter Series



#### Indoor Unit

**R32**  
**R410A**



PSA-M71/100/125/140KA

#### Outdoor Unit

**R32**

For Single



SUZ-M71



PUZ-M100/125/140

**R32**

For Multi  
(Twin/Triple)



PUZ-M140



PUZ-M200/250

#### Remote Controller



Built-in



Optional\*

\* PAR-SA9CA-E is also required.

### PSA-M Indoor Unit Combinations Indoor unit combinations shown below are possible.

Indoor Unit Combination	Outdoor Unit Capacity																			
	For Single									For Twin					For Triple			For Quadruple		
	35	50	60	71	100	125	140	200	250	71	100	125	140	200	250	140	200	250	200	250
Standard Inverter (PUZ-M)	-	-	-	71x1	100x1	125x1	140x1	-	-	-	-	-	71x2	100x2	125x2	-	-	71x3	-	-
Distribution Pipe	-	-	-	-	-	-	-	-	-	-	-	-	MSDD-50TR2-E	MSDD-50WR2-E	-	-	MSDT-111R3-E	-	-	

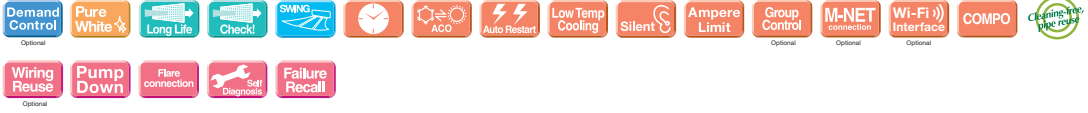

**PSA-M SERIES**  
POWER INVERTER

Type			Inverter Heat Pump							
Indoor Unit			PSA-M71KA	PSA-M100KA	PSA-M100KA	PSA-M125KA	PSA-M125KA	PSA-M140KA	PSA-M140KA	
Outdoor Unit			PUZ-ZM71VHA2	PUZ-ZM100VKA2	PUZ-ZM100VKA2	PUZ-ZM125VKA2	PUZ-ZM125VKA2	PUZ-ZM140VKA2	PUZ-ZM140VKA2	
Refrigerant <sup>(1)</sup>			R32							
Power Source			Outdoor power supply							
Supply Outdoor(V/Phase/Hz)			VA, VKA:230/Single/50, YKA:400/Three/50							
Cooling	Capacity	Rated	kW	7.1	9.5	9.5	12.5	12.5	13.4	13.4
		Min-Max	kW	3.3 - 8.1	4.9 - 11.4	4.9 - 11.4	5.5 - 14.0	5.5 - 14.0	6.2 - 15.0	6.2 - 15.0
	Total Input	Rated	kW	1.888	2.493	2.493	3.955	3.955	3.976	3.976
	EER	Rated		3.76	3.81	3.81	3.16	3.16	3.37	3.37
	Design load		kW	7.1	9.5	9.5	—	—	—	—
Heating	Capacity	Rated	kW	7.6	11.2	11.2	14.0	14.0	16.0	16.0
		Min-Max	kW	3.5 - 10.2	4.5 - 14.0	4.5 - 14.0	5 - 16.0	5 - 16.0	5.7 - 18.0	5.7 - 18.0
	Total Input	Rated	kW	2.338	3.172	3.172	4.501	4.501	5.000	5.000
	COP	Rated		3.25	3.53	3.53	3.11	3.11	3.20	3.20
	Design load		kW	4.7	7.8	7.8	—	—	—	—
Operating Current(Max)	Input [cooling / Heating]	Rated	kW	0.06 / 0.06	0.11 / 0.11	0.11 / 0.11	0.11 / 0.11	0.11 / 0.11	0.11 / 0.11	0.11 / 0.11
	Operating Current(Max)		A	0.4	0.71	0.71	0.73	0.73	0.73	0.73
	Dimensions	H*W*D	mm	1900-600-360	1900-600-360	1900-600-360	1900-600-360	1900-600-360	1900-600-360	1900-600-360
	Weight		kg	46	46	46	46	46	48	48
	Air Volume (Lo-Mi2-Mi1-Hi)		m³/min	20-22-24	25-28-30	25-28-30	25-28-31	25-28-31	25-28-31	25-28-31

\*1 Refrigerant leakage contributes to climate change. Refrigerant with lower global warming potential (GWP) would contribute less to global warming than a refrigerant with higher GWP if leaked to the atmosphere. This appliance contains a refrigerant fluid with a GWP equal to 1975. This means that if 1 kg of this refrigerant fluid would be leaked to the atmosphere, the impact on global warming would be 1975 times higher than 1 kg of CO<sub>2</sub> over a period of 100 years. Never try to interfere with the refrigerant circuit yourself or disassemble the product yourself and always ask a professional. The GWP of R410A is 2088 in the IPCC 4th Assessment Report.  
 \*2 Energy consumption based on standard test results. Actual energy consumption will depend on how the appliance is used and where it is located.  
 \*3 Optional air protection guide is required where ambient temperature is lower than -5°C. \*4 SEER and SCOP are based on 2009/125/EC Energy-related Products Directive and Regulation(EU) No206/2012.

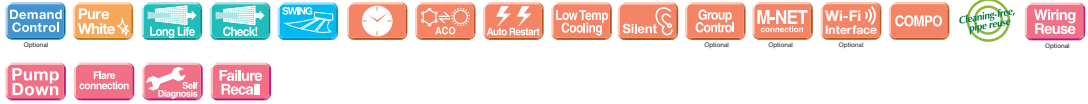

**PSA-M SERIES**  
STANDARD INVERTER

Type			Inverter Heat Pump							
Indoor Unit			PSA-M71KA	PSA-M100KA	PSA-M100KA	PSA-M125KA	PSA-M125KA	PSA-M140KA	PSA-M140KA	
Outdoor Unit			SUZ-M71VA	PUZ-M100VKA2	PUZ-M100VKA2	PUZ-M125VKA2	PUZ-M125VKA2	PUZ-M140VKA2	PUZ-M140VKA2	
Refrigerant <sup>(1)</sup>			R32							
Power Source			Outdoor power supply							
Supply Outdoor(V/Phase/Hz)			VA, VKA:230/Single/50, YKA:400/Three/50							
Cooling	Capacity	Rated	kW	7.1	9.4	9.4	12.1	12.1	13.6	13.6
		Min-Max	kW	2.2 - 8.1	3.7 - 10.6	3.7 - 10.6	5.6 - 13.0	5.6 - 13.0	5.8 - 13.7	5.8 - 13.7
	Total Input	Rated	kW	1.972	2.686	2.686	4.481	4.481	5.037	5.037
	EER	Rated		3.60	3.50	3.50	2.70	2.70	2.70	2.70
	Design load		kW	7.1	9.4	9.4	—	—	—	—
Heating	Capacity	Rated	kW	8.0	11.2	11.2	13.5	13.5	15.0	15.0
		Min-Max	kW	2.1 - 10.2	2.8 - 12.5	2.8 - 12.5	4.8 - 15.0	4.8 - 15.0	4.9 - 15.8	4.9 - 15.8
	Total Input	Rated	kW	2.492	3.246	3.246	4.355	4.355	4.761	4.761
	COP	Rated		3.21	3.45	3.45	3.10	3.10	3.15	3.15
	Design load		kW	5.8	8.0	8.0	—	—	—	—
Operating Current(Max)	Input [cooling / Heating]	Rated	kW	0.06 / 0.06	0.11 / 0.11	0.11 / 0.11	0.11 / 0.11	0.11 / 0.11	0.11 / 0.11	0.11 / 0.11
	Operating Current(Max)		A	0.4	0.71	0.71	0.73	0.73	0.73	0.73
	Dimensions	H*W*D	mm	1900-600-360	1900-600-360	1900-600-360	1900-600-360	1900-600-360	1900-600-360	1900-600-360
	Weight		kg	46	46	46	46	46	48	48
	Air Volume (Lo-Mi2-Mi1-Hi)		m³/min	20-22-24	25-28-30	25-28-30	25-28-31	25-28-31	25-28-31	25-28-31

\*1 Refrigerant leakage contributes to climate change. Refrigerant with lower global warming potential (GWP) would contribute less to global warming than a refrigerant with higher GWP if leaked to the atmosphere. This appliance contains a refrigerant fluid with a GWP equal to 1975. This means that if 1 kg of this refrigerant fluid would be leaked to the atmosphere, the impact on global warming would be 1975 times higher than 1 kg of CO<sub>2</sub> over a period of 100 years. Never try to interfere with the refrigerant circuit yourself or disassemble the product yourself and always ask a professional. The GWP of R410A is 2088 in the IPCC 4th Assessment Report.  
 \*2 Energy consumption based on standard test results. Actual energy consumption will depend on how the appliance is used and where it is located.  
 \*3 Optional air protection guide is required where ambient temperature is lower than -5°C.  
 \*4 SEER and SCOP are based on 2009/125/EC Energy-related Products Directive and Regulation(EU) No206/2012.  
 \*5 Joint pipe is required depending on installed refrigerant pipes, outdoor units and indoor units.









## PLA-SM SERIES SERIES SELECTION

### Indoor Unit



PLA-SM71/100/125/140EA

### Outdoor Unit



SUZ-SM71VA



PUZ-SM100/125/140VKA2  
PUZ-SM100/125/140YKA2

### Optional

PLP-6EAJ - Panel only  
PLP-6EALM - Panel with signal receiver and wireless remote controller



PAR-41MAA(B)  
DELUXE



PAC-YT52CRA



PAR-SL100A\*

\*Enclosed with PLP-6EALM

## PLA-SM SERIES

Type			Inverter Heat Pump					
Indoor Unit			PLA-SM71EA	PLA-SM100EA		PLA-SM125EA		PLA-SM140EA
Outdoor Unit			SUZ-SM71VA	PUZ-SM100VKA	PUZ-SM100YKA	PUZ-SM125VKA	PUZ-SM125YKA	PUZ-SM140VKA   PUZ-SM140YKA
Refrigerant			R32 <sup>(1)</sup>					
Power Supply			Outdoor power supply					
Source			VA - VKA:230 / Single / 50, YKA:400 / Three / 50					
Outdoor (V / Phase / Hz)								
Cooling	Capacity	Rated	kW	7,1	9,5	9,5	12,1	13,4
		Min-Max	kW	2,2-8,1	4,0-10,6	4,0-10,6	5,8-13,0	5,8-14,1
	Total Input	Rated	kW	1,97	2,79	2,79	4,17	5,13
	EER			3,6	3,4	3,4	2,9	2,61
	EEL Rank			-	-	-	-	-
	Design load		kW	7,1	9,5	9,5	12,1	13,4
	Annual electricity consumption <sup>(*)2</sup>		kWh/a	410	554	554	-	-
	SEER			6	6	6	-	-
Energy efficiency class				A+	A+	A+	-	-
Heating (Average Season)	Capacity	Rated	kW	8	11,2	11,2	13,5	15
		Min-Max	kW	2,0-10,2	2,8-12,5	2,8-12,5	4,1-15,0	4,2-15,8
	Total Input	Rated	kW	2,28	3,1	3,1	3,73	4,54
	COP			3,5	3,61	3,61	3,61	3,3
	EEL Rank			-	-	-	-	-
	Design load		kW	5,8	8	8	8,5	9,4
	Declared Capacity	at reference design temperature	kW	5,2 (-10°C)	6,0 (-10°C)	6,0 (-10°C)	8,5 (-10°C)	9,4 (-10°C)
		at bivalent temperature	kW	5,2 (-7°C)	7,0 (-7°C)	7,0 (-7°C)	8,5 (-10°C)	9,4 (-10°C)
		at operation limit temperature	kW	5,2 (-10°C)	4,5 (-15°C)	4,5 (-15°C)	6,0 (-15°C)	7,0 (-15°C)
	Back up heating capacity		kW	0,6	2	2	0	0
Annual electricity consumption <sup>(*)2</sup>		kWh/a	2066	2482	2482	-	-	
SCOP			3,9	4,5	4,5	-	-	
Energy efficiency class				A	A+	A+	-	-
Operating Current (Max)				15,1	20,5	12	27,2	12,2
Indoor Unit	Input (cooling/heating)	Rated	kW	0,04	0,07	0,07	0,1	0,1
	Operating Current (Max)		A	0,27	0,46	0,46	0,66	0,66
	Dimensions <Panel>	HxWxD	mm	258x640x840<40x950x950>		298x840x840<40x950x950>		
	Weight <Panel>		kg	21<5>		24<5>		26<5>
Air Volume (Lo-Mid-Hi)		m³/min	14-17-19-21		19-23-26-29		21-25-28-32	
Sound Level (Lo-Mid-Hi) (SPL)		dB(A)	28-30-32-34		31-34-37-40		33-37-41-44	
Sound Level (PWL)		dB(A)	56		61		65	
Dimensions	HxWxD	mm	880x840x330		981x1050x330 (+40)			
Outdoor Unit	Weight		kg	55	76	78	84	85
	Air Volume	Cooling	m³/min	50,1	79	79	86	86
		Heating	m³/min	50,1	79	79	92	92
	Sound Level (SPL)	Cooling	dB(A)	49	51	51	54	55
		Heating	dB(A)	51	54	54	56	57
	Sound Level (PWL)	Cooling	dB(A)	66	70	70	72	73
	Operating Current (Max)		A	14,8	20	11,5	26,5	11,5
	Breaker Size		A	20	32	16	32	16
Ext. Piping	Diameter	Liquid/Gas	mm	9,52 / 15,88				
	Max. Length	Out-In	m	30		40		
	Max. Height	Out-In	m	30				
Guaranteed Operating Range (Outdoor)	Cooling	°C	-15 ~ +46					
	Heating	°C	-10 ~ +24		-15 ~ +21			
Refrigerant/GWP			R32/675 <sup>(*)4</sup>					
Pre-Charged quantity	Weight	kg	1,45	3,1	3,1	3,6	3,6	
	CO <sub>2</sub> equivalent	t	0,98	2,09	2,09	2,43	2,43	
Max added quantity	Weight	kg	2,37	4,1	4,1	5	5	
	CO <sub>2</sub> equivalent	t	1,6	2,77	2,77	3,38	3,38	

<sup>(\*)1</sup> Refrigerant leakage contributes to climate change. Refrigerant with lower global warming potential (GWP) would contribute less to global warming than a refrigerant with higher GWP, if leaked to the atmosphere. This appliance contains a refrigerant fluid with a GWP equal to 1975. This means that if 1 kg of this refrigerant fluid would be leaked to the atmosphere, the impact on global warming would be 1975 times higher than 1 kg of CO<sub>2</sub> over a period of 100 years. Never try to interfere with the refrigerant circuit yourself or disassemble the product yourself and always ask a professional.

<sup>(\*)2</sup> Energy consumption based on standard test results. Actual energy consumption will depend on how the appliance is used and where it is located.

<sup>(\*)3</sup> Optional air protection guide is required where ambient temperature is lower than -5°C.

<sup>(\*)4</sup> This GWP value is based on Regulation (EU) No 517/2014 from IPCC 4th edition.



## PEAD-SM SERIES SERIES SELECTION

### Indoor Unit



PEAD-SM71/100/125/140JAL(2)

### Outdoor Unit



SUZ-SM71VA



PUZ-SM100/125/140VKA  
PUZ-SM100/125/140YKA



PAR-41MAA(B)  
Optional



PAC-YT52CRA  
Optional



PAR-FL32MA  
Optional

## PEAD-SM SERIES

Type			Inverter Heat Pump							
Indoor Unit			PEAD-SM71JA (L)	PEAD-SM100JA (L)	PEAD-SM100JA (L)	PEAD-SM125JA (L)	PEAD-SM125JA (L)	PEAD-SM140JA (L)	PEAD-SM140JA (L)	
Outdoor Unit			SUZ-SM71VA	PUZ-SM100VKA	PUZ-SM100YKA	PUZ-SM125VKA	PUZ-SM125YKA	PUZ-SM140VKA	PUZ-SM140YKA	
Refrigerant			R32 <sup>(*)</sup>							
Power Supply			Outdoor power supply							
Source			VA - VKA:230 / Single / 50, YKA:400 / Three / 50							
Outdoor (V / Phase / Hz)										
Cooling	Capacity	Rated	kW	7,1	9,5	9,5	12,1		13,4	
		Min-Max	kW	2,2-8,1	4,0-10,6	4,0-10,6	6,0-13,0		6,1-14,1	
	Total Input	Rated	kW	2,08	2,95	2,95	4,17		4,96	
	EER			3,41	3,21	3,21	2,9		2,7	
	EEL Rank			-	-	-	-		-	
	Design load		kW	7,1	9,5	9,5	12,1		13,4	
	Annual electricity consumption (**)		kWh/a	451	626	626	-		-	
	SEER			5,5	5,3	5,3	-		-	
	Energy efficiency class			A	A	A	-		-	
	Heating (Average Season)	Capacity	Rated	kW	8	11,2	11,2	13,5		15
Min-Max			kW	2,0-10,2	2,8-12,5	2,8-12,5	4,1-15,0		4,2-15,8	
Total Input		Rated	kW	2,21	3,02	3,02	3,85		4,28	
COP				3,61	3,7	3,7	3,5		3,5	
EEL Rank				-	-	-	-		-	
Design load			kW	5,8	8	8	8,5		9,4	
Declared Capacity		at reference design temperature	kW	5,2 (-6°C)	6,0 (-10°C)	6,0 (-10°C)	8,5 (-10°C)		9,4 (-10°C)	
		at bivalent temperature	kW	5,2 (-7°C)	7,0 (-7°C)	7,0 (-7°C)	8,5 (-10°C)		9,4 (-10°C)	
		at operation limit temperature	kW	5,2 (-10°C)	4,5 (-15°C)	4,5 (-15°C)	6,0 (-15°C)		7,0 (-15°C)	
Back up heating capacity			kW	0,6	2	2	0		0	
Annual electricity consumption (**)		kWh/a	2080	2865	2865	-		-		
SCOP			3,9	3,9	3,9	-		-		
Energy efficiency class			A	A	A	-		-		
Operating Current (Max)			A	16,8	22,7	14,2	29,3	14,3	32,8	14,3
Indoor Unit	Input (cooling/heating)	Rated	kW	0,17 / 0,15	0,25 (0,23) / 0,23	0,25 (0,23) / 0,23	0,36 (0,34) / 0,34	0,36 (0,34) / 0,34	0,39 (0,37) / 0,37	0,39 (0,37) / 0,37
	Operating Current (Max)		A	1,97	2,65	2,65	2,76	2,76	2,78	2,78
	Dimensions	HxWxD	mm	250-1100-732	250-1400-732	250-1400-732	250-1400-732	250-1400-732	250-1600-732	250-1600-732
	Weight (L:No Drain Pump)		kg	30 (29)	39 (38)	39 (38)	40 (39)	40 (39)	44 (43)	44 (43)
	Air Volume (Lo-Mid-Hi)		m <sup>3</sup> /min	17,5-21,0-25,0	24,0-29,0-34,0	24,0-29,0-34,0	29,5-35,5-42,0	29,5-35,5-42,0	32,0-39,0-46,0	32,0-39,0-46,0
	External Static Pressure		Pa	35 / 50 / 70 / 100						
	Sound Level (Lo-Mid-Hi) (SPL)		dB(A)	26-30-34	29-34-38		33-36-40		34-38-43	
	Sound Level (PWL)		dB(A)	58	62		66		67	
	Dimensions	HxWxD	mm	880x840x330			981x1050x330 (+40)			
	Outdoor Unit	Weight		kg	55	76	78	84	85	84
Air Volume		Cooling	m <sup>3</sup> /min	50,1	79	79	86	86	86	86
		Heating	m <sup>3</sup> /min	50,1	79	79	92	92	92	92
Sound Level (SPL)		Cooling	dB(A)	49	51	51	54	54	55	55
		Heating	dB(A)	51	54	54	56	56	57	57
Sound Level (PWL)		Cooling	dB(A)	66	70	70	72	72	73	73
		Heating	dB(A)	66	70	70	72	72	73	73
Operating Current (Max)			A	14,8	20	11,5	26,5	11,5	30	11,5
Breaker Size			A	20	32	16	32	16	40	16
Ext. Piping		Diameter	Liquid/Gas	mm	9,52 / 15,88					
	Max. Length	Out-In	m	30			40			
	Max. Height	Out-In	m	30						
Guaranteed Operating Range (Outdoor)	Cooling <sup>(*)</sup>	°C	-15 ~ +46							
	Heating	°C	-10 ~ +24			-15 ~ +21				
Refrigerant/GWP			R32/675 <sup>(**)</sup>							
Pre-Charged quantity	Weight	kg	1,45	3,10	3,10	3,60	3,60	3,60	3,60	
	CO <sub>2</sub> equivalent	t	0,98	2,09	2,09	2,43	2,43	2,43	2,43	
Max added quantity	Weight	kg	2,37	4,10	4,10	5,00	5,00	5,00	5,00	
	CO <sub>2</sub> equivalent	t	1,60	2,77	2,77	3,38	3,38	3,38	3,38	

(\*) Refrigerant leakage contributes to climate change. Refrigerant with lower global warming potential (GWP) would contribute less to global warming than a refrigerant with higher GWP, if leaked to the atmosphere. This appliance contains a refrigerant fluid with a GWP equal to 1975. This means that if 1 kg of this refrigerant fluid would be leaked to the atmosphere, the impact on global warming would be 1975 times higher than 1 kg of CO<sub>2</sub>, over a period of 100 years. Never try to interfere with the refrigerant circuit yourself or disassemble the product yourself and always ask a professional.  
 (\*\*) Energy consumption based on standard test results. Actual energy consumption will depend on how the appliance is used and where it is located.  
 (\*\*\*) Optional air protection guide is required where ambient temperature is lower than -5°C.  
 (\*\*\*\*) This GWP value is based on Regulation(EU) No 517/2014 from IPCC 4th edition.













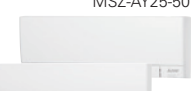
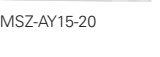







# MULTI SPLIT

SERIES



# SELECTION

Choose from types of indoor units and outdoor units that can run up to six indoor units each. Create the system that best matches room shapes and number of rooms.

R32 INDOOR UNITS		R32 OUTDOOR UNITS		
<b>Wall-mounted</b>  MSZ-LN (18•25•35•50)  MSZ-EF  MSZ-AY25-50  MSZ-AY15-20  MSZ-AP60VG  MSZ-BT	<b>Floor-standing</b>  MFZ-KT  SFZ	<b>2-port</b> up to 2 indoor units  MXZ-2F33VF4 MXZ-2F42VF4 MXZ-2F53VF(H)4	<b>3-port</b> up to 3 indoor units  MXZ-3F54VF4 MXZ-3F68VF4	<b>4-port</b> up to 4 indoor units  MXZ-4F72VF4 MXZ-4F80VF4  MXZ-4F83VF2
	<b>Ceiling-suspended</b>  PCA	<b>5-port</b> up to 5 indoor units  MXZ-5F102VF2	<b>6-port</b> up to 6 indoor units  MXZ-6F120VF2	
<b>Cassette</b>  SLZ  MLZ-KP  MLZ-KY	<b>Ceiling-concealed</b>  SEZ  PEAD	<b>Hyper Heating</b>  MXZ-2F53VFHZ2  MXZ-4F83VFHZ2		

## CHECK SYSTEM COMPATIBILITY

Possible combinations depends on the outdoor unit chosen. Please check the following points.

### Check Indoor Units

Refer to the "Indoor Unit Compatibility Table" to check if the indoor units selected can be used with the outdoor unit selected. (Indoor units not listed in the table cannot be used.)

### Check Indoor Unit Capacity Combination

Refer to the "Combination Table" to check if the capacity combination of the indoor unit selected is connectable. (Combinations not listed cannot be connected.)

**If the desired combination cannot be found, please change either the indoor or outdoor unit to match one of the combinations shown in the tables.**

# MXZ SERIES

Advancements in the MXZ Series include efficiency and flexibility in system expansion capabilities. The best solution when requiring multi-system air conditioning needs.

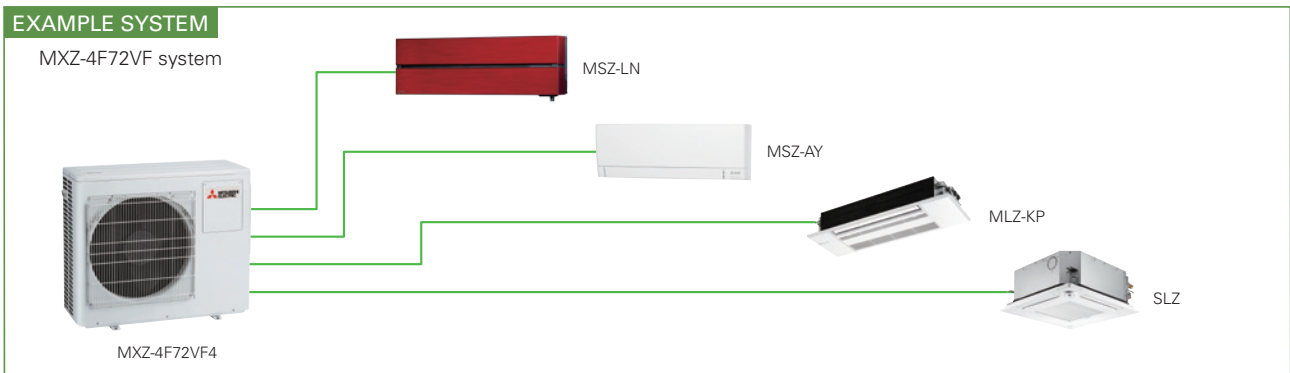
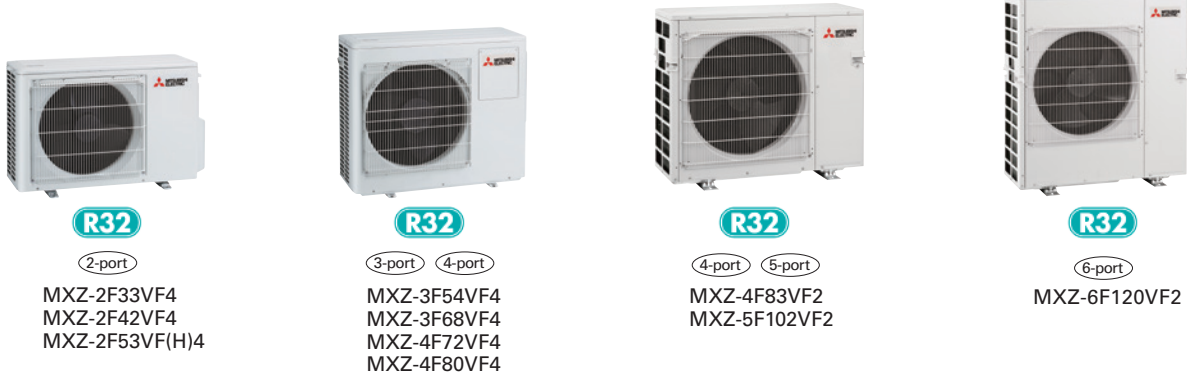
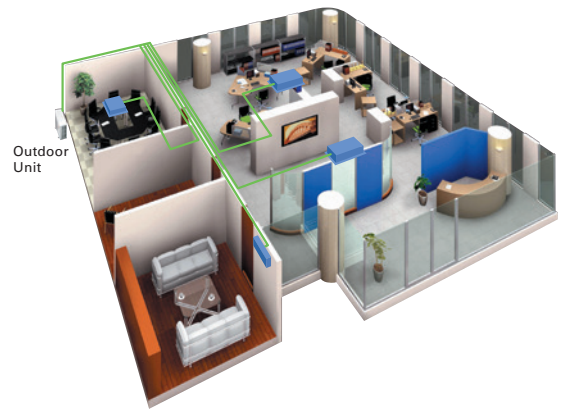

## Units can be used even if it is connected to only one indoor unit (4F83/5F102/6F120)

This unit can be used even if it is connected to only one indoor unit. This offers more flexibility for wide range of application that satisfies various customers' demand.

## No necessity for refrigerant charging

Depending on the pipe length and the indoor units that are connected, conventional models have required refrigerant charging, but no R32 MXZ model needs to be charged with additional refrigerant. This eliminates troublesome work at the site of installation, and reduces the amount of additional work for the installer.

## Handle Up to 6 Rooms with a Single Outdoor Unit

The MXZ Series for R32 offers a ten-system line-up to choose from, ranging between 3.3 and 12.0kW. All of them are compatible with specific M, S and P series indoor units. A single outdoor unit can handle a wide range of building layouts.

## Support Functions

### Wiring/Piping Correction Function\* (3F54/3F68/4F72/4F80/4F83/5F102/6F120)

Simply press a single button to confirm if wiring and piping are properly connected. Wiring errors are corrected automatically when discovered. This eliminates the need to confirm complicated wiring connections when expanding the system. (For details, refer to the outdoor unit installation manual.)

\* Function cannot be used when the outdoor temperature is below 0°C. The correction process requires 10–20 minutes to complete and must be conducted with the unit set to the "Cooling" mode.

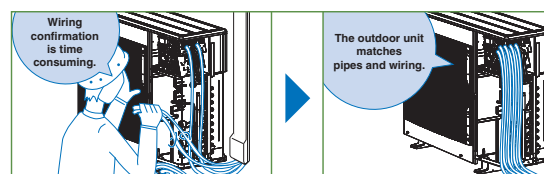

## Operation Lock

To accommodate specific use applications, cooling or heating operation can be specified when setting the control board of the outdoor unit. A convenient option when a system needs to be configured for exclusive cooling or heating service. (For details, refer to the outdoor unit installation manual.)



Type (Inverter Multi - Split Heat Pump)				Up to 2 Indoor Units				Up to 3 Indoor Units			Up to 4 Indoor Units			Up to 5 Indoor Units		
Indoor Unit				Please refer to*3												
Outdoor Unit				MXZ-2F33VF4	MXZ-2F42VF4	MXZ-2F53VF4	MXZ-2F53VFH4	MXZ-3F54VF4	MXZ-3F68VF4	MXZ-4F72VF4	MXZ-4F80VF4	MXZ-4F83VF2	MXZ-5F102VF2			
Refrigerant				R32												
Power Source				Outdoor power supply												
Supply Outdoor (V/Phase/Hz)				220 - 230 - 240V / Single / 50Hz												
Cooling	Capacity	Rated	kW	3.3	4.2	5.3	5.3	5.4	6.8	7.2	8.0	8.3	10.2			
	Input	Rated	kW	0.85	0.98	1.40	1.40	1.32	1.84	1.85	2.25	1.97	2.80			
	Design Load		kW	3.3	4.2	5.3	5.3	5.4	6.8	7.2	8.0	8.3	10.2			
	Annual Electricity Consumption*1		kWh/a	189	169	216	216	222	301	311	368	342	436			
	SEER*3			6.1	8.7	8.6	8.6	8.5	7.9	8.1	7.6	8.5	8.2			
			Energy Efficiency Class*3	A++	A+++	A+++	A+++	A+++	A++	A++	A++	A++	A+++	A++		
Heating	Capacity	Rated	kW	4.0	4.5	6.4	6.4	7.0	8.6	8.6	8.8	9.3	10.5			
	Input	Rated	kW	0.91	0.88	1.56	1.56	1.40	1.91	1.87	2.00	2.00	2.28			
	Design Load		kW	2.7	3.5	3.5	3.5	5.2	6.8	7.0	7.0	7.0	7.4			
	Declared Capacity	at reference design temperature	kW	2.2	2.7	2.7	2.7	4.2	5.7	5.6	5.6	5.8	5.9			
		at bivalent temperature	kW	2.4	2.9	2.9	2.9	4.8	6.4	6.2	6.2	6.2	6.4			
		at operation limit temperature	kW	1.6	2.3	2.3	2.1	3.2	4.6	4.8	4.8	4.9	4.9			
	Back Up Heating Capacity		kW	0.5	0.8	0.8	0.8	1.0	1.1	1.4	1.4	1.2	1.5			
	Annual Electricity Consumption*1		kWh/a	944	1065	1065	1089	1583	2321	2389	2389	2087	2205			
	SCOP*3			4.0	4.6	4.6	4.5	4.6	4.1	4.1	4.1	4.7	4.7			
			Energy Efficiency Class*3	A+	A++	A++	A+	A++	A+	A+	A+	A++	A++			
Max. Operating Current (Indoor+Outdoor)				A	10.0	12.2	12.2	12.2	18.0	18.0	18.0	18.0	21.4	21.4		
Outdoor Unit	Dimensions	H x W x D	mm	550 - 800 (+69) - 285 (+59.5)				710 - 840 - 330 (+66)				796 - 950 - 330				
	Weight		kg	33	37	37	38	58	58	59	59	62	62			
	Air Volume	Cooling	m³/min	30.8	28.4	32.7	32.7	31	35.4	35.4	40.3	57	63			
		Heating	m³/min	32.3	33.5	34.7	34.7	31	39.6	42.7	44.1	62	75			
	Sound Level (SPL)	Cooling	dB(A)	49	44	46	46	46	48	48	50	49	52			
		Heating	dB(A)	50	50	51	51	50	53	54	55	51	56			
	Sound Level (PWL)	Cooling	dB(A)	60	59	61	61	60	63	63	65	61	65			
Breaker Size		A	15	15	15	15	25	25	25	25	25	25				
Ext. Piping	Port Diameter	Liquid	mm	6.35 x 2	6.35 x 2	6.35 x 2	6.35 x 2	6.35 x 3	6.35 x 3	6.35 x 4	6.35 x 4	6.35 x 4	6.35 x 5			
		Gas	mm	9.52 x 2	9.52 x 2	9.52 x 2	9.52 x 2	9.52 x 3	9.52 x 3	12.7 x 1+9.52 x 3	12.7 x 1+9.52 x 3	12.7 x 1+9.52 x 3	12.7 x 1+9.52 x 4			
	Total Piping Length (max)		m	20	30	30	30	50	60	60	70	80				
	Each Indoor Unit Piping Length (max)		m	15	20	20	20	25	25	25	25	25	25			
	Max. Height		m	10	15 (10)*2	15 (10)*2	15 (10)*2	15 (10)*2	15 (10)*2	15 (10)*2	15 (10)*2	15	15			
Chargeless Length		m	20	30	30	30	50	60	60	60	70	80				
Guaranteed Operating Range [Outdoor]	Cooling	°C	-10 ~ +46	-10 ~ +46	-10 ~ +46	-10 ~ +46	-10 ~ +46	-10 ~ +46	-10 ~ +46	-10 ~ +46	-10 ~ +46	-10 ~ +46	-10 ~ +46			
	Heating	°C	-15 ~ +24	-15 ~ +24	-15 ~ +24	-20 ~ +24	-15 ~ +24	-15 ~ +24	-15 ~ +24	-15 ~ +24	-15 ~ +24	-15 ~ +24	-15 ~ +24			
Refrigerant/GWP			R32/675*4	R32/675*4	R32/675*4	R32/675*4	R32/675*4	R32/675*4	R32/675*4	R32/675*4	R32/675*4	R32/675*3	R32/675*3			
Pre-Charged Quantity	Weight	kg	0.8	1.0	1.0	1.0	2.4	2.4	2.4	2.4	2.4	2.4	2.4			
	CO <sub>2</sub> equivalent	t	0.54	0.68	0.68	0.68	1.62	1.62	1.62	1.62	1.62	1.62	1.62			
Max Added Quantity	Weight	kg	0.8	1.0	1.0	1.0	2.4	2.4	2.4	2.4	2.4	2.4	2.4			
	CO <sub>2</sub> equivalent	t	0.54	0.68	0.68	0.68	1.62	1.62	1.62	1.62	1.62	1.62	1.62			

Type (Inverter Multi - Split Heat Pump)				Up to 6 Indoor Units							
Indoor Unit				Please refer to*3							
Outdoor Unit				MXZ-6F120VF2							
Refrigerant				R32							
Power Source				Outdoor power supply							
Supply Outdoor (V/Phase/Hz)				220 - 230 - 240V / Single / 50Hz							
Cooling	Capacity	Rated	kW	12.0							
	Input	Rated	kW	3.60							
	Design Load		kW	12.0							
	Annual Electricity Consumption*1		kWh/a	612							
	SEER*3			6.86							
			Energy Efficiency Class*3	A++							
Heating	Capacity	Rated	kW	14.0							
	Input	Rated	kW	3.31							
	Design Load		kW	8.1							
	Declared Capacity	at reference design temperature	kW	6.9							
		at bivalent temperature	kW	7.6							
		at operation limit temperature	kW	5.7							
	Back Up Heating Capacity		kW	1.2							
	Annual Electricity Consumption*1		kWh/a	2794							
	SCOP*3			4.06							
			Energy Efficiency Class*3	A+							
Max. Operating Current (Indoor+Outdoor)				A				29.8			
Outdoor Unit	Dimensions	H x W x D	mm	1048 - 950 - 330							
	Weight		kg	87							
	Air Volume	Cooling	m³/min	63							
		Heating	m³/min	77							
	Sound Level (SPL)	Cooling	dB(A)	55							
		Heating	dB(A)	57							
	Sound Level (PWL)	Cooling	dB(A)	69							
Breaker Size		A	32								
Ext. Piping	Port Diameter	Liquid	mm	6.35 x 6							
		Gas	mm	12.7 x 1 + 9.52 x 5							
	Total Piping Length (max)		m	80							
	Each Indoor Unit Piping Length (max)		m	25							
	Max. Height		m	15							
Chargeless Length		m	80								
Guaranteed Operating Range [Outdoor]	Cooling	°C	-10 ~ +46								
	Heating	°C	-15 ~ +24								
Refrigerant/GWP			R32/675*4								
Pre-Charged Quantity	Weight	kg	2.4								
	CO <sub>2</sub> equivalent	t	1.62								
Max Added Quantity	Weight	kg	2.4								
	CO <sub>2</sub> equivalent	t	1.62								

\*1 Energy consumption based on standard test results.

Actual energy consumption will depend on how the appliance is used and where it is located.

\*2 If the outdoor unit is installed higher than the indoor unit, max. height is reduced to 10 m.

\*3 SEER/SCOP values and energy efficiency class are measured when connected to the indoor units listed below.

MXZ-2F33VF4 MSZ-AY15VGIPI + MSZ-LN18VG2  
 MXZ-2F42VF4 MSZ-LN18VG2 + MSZ-LN25VG2  
 MXZ-2F53VF4/VFH4 MSZ-LN18VG2 + MSZ-LN35VG2  
 MXZ-3F54VF4 MSZ-LN18VG2 + MSZ-LN18VG2 + MSZ-LN18VG2  
 MXZ-3F68VF4 MSZ-LN18VG2 + MSZ-LN25VG2 + MSZ-LN25VG2  
 MXZ-4F72VF4 MSZ-LN18VG2 + MSZ-LN18VG2 + MSZ-LN18VG2 + MSZ-LN18VG2  
 MXZ-4F80VF4 MSZ-LN18VG2 + MSZ-LN18VG2 + MSZ-LN18VG2 + MSZ-LN25VG2  
 MXZ-4F83VF2 MSZ-LN18VG + MSZ-LN18VG + MSZ-LN25VG + MSZ-LN25VG  
 MXZ-5F102VF2 MSZ-LN18VG2 + MSZ-LN18VG2 + MSZ-LN18VG2 + MSZ-LN25VG2 + MSZ-LN25VG2  
 MXZ-6F120VF2 MSZ-LN18VG2 + MSZ-LN18VG2 + MSZ-LN18VG2 + MSZ-LN18VG2 + MSZ-LN25VG2 + MSZ-LN25VG2

\*4 This GWP value is based on Regulation (EU) No 517/2014 from IPCC 4th edition.

# MXZ-VFHZ SERIES

New hyper-heating MXZ allows you to create an oasis of comfort throughout your home and office in the rooms you use most, any time of the year.



## Standard rated heating capacity is maintained even when the outside-air temperature drops to $-15^{\circ}\text{C}$ .

Maintains high capacity output even when outside-air temperature is low.

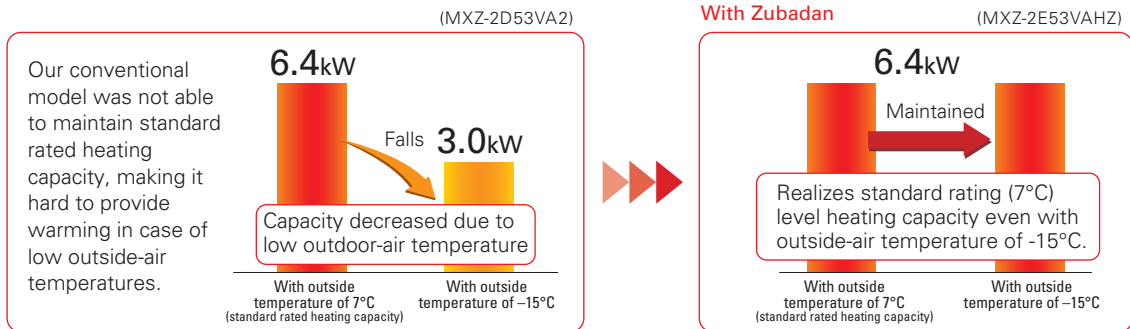

## Can operate at outside-air temperature of $-25^{\circ}\text{C}$

1. Incorporated key parts resistant to cold of up to  $-25^{\circ}\text{C}$  after rigorous selection.
2. Printed circuit board-core of the air conditioner—is coated on both sides to protect it in harsh environments.

## Equipped Freeze-prevention heater as standard

Prevents capacity loss and operation from stopping due to drain water freezing.

Drain water **freezes** after operation in the harsh cold



With Hyper heating Does not freeze!

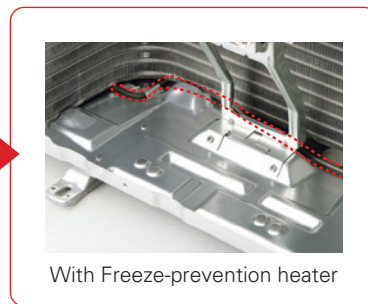

\*Image is for illustration purposes. The actual performance depends on outdoor temperature.

## Continuous heating for long periods

Wasteful defrosting operation suppressed to enable more comfortable long-term continuous heating.

Extremely cold outside

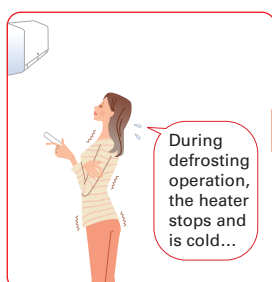

With Hyper heating

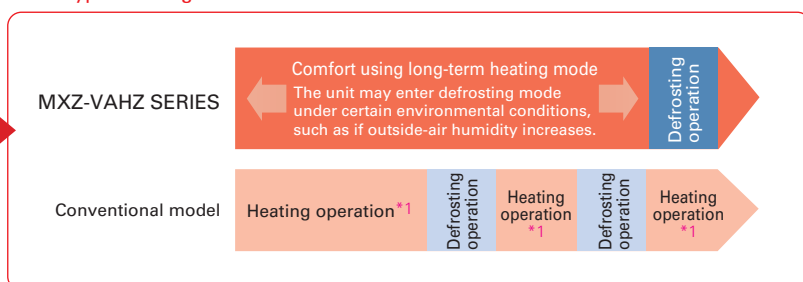

\*1: Conventional model performs continuous heating approximately 30min up to a maximum of 90min.



## One outdoor unit supports multiple indoor units.

With MXZ-VFHZ, one outdoor unit can cool and heat up to six rooms. They can be installed neatly in sites with limited space such as condominium balconies.

\*Please note that cooling and heating modes cannot be run simultaneously in different rooms.

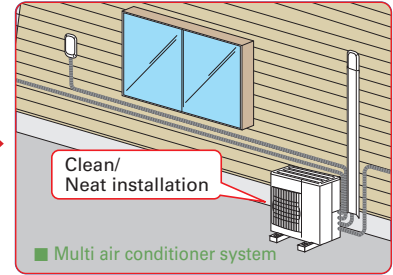
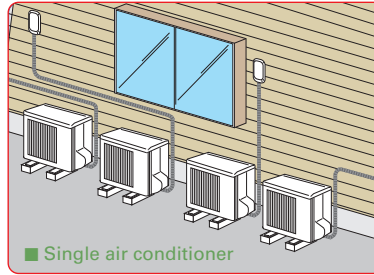

### EXAMPLE SYSTEM

MXZ-4F83VFHZ2 system

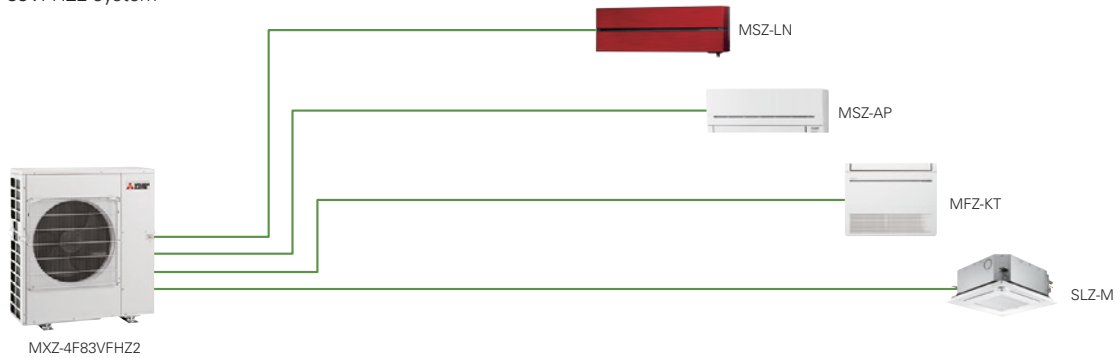

## Freedom of combinations in cold region greatly enhanced

The variety of indoor unit connection options in cold regions, restricted until now, has been greatly increased. Increased design freedom.

### OUTDOOR UNITS

2-room use



4-room use



### INDOOR UNITS

Wall-mounted



Floor-standing



Cassette



Ceiling-concealed



# MXZ-VFHZ SERIES



## Outdoor Unit

R32



MXZ-2F53VFHZ2

R32



MXZ-4F83VFHZ2

Type			Inverter Heat Pump			
Indoor Unit			Please refer to *2 *3			
Outdoor Unit			MXZ-2F53VFHZ2	MXZ-4F83VFHZ2		
Refrigerant			R32*4			
Power Supply			Outdoor power supply			
Outdoor (V/Phase/Hz)			220 - 230 - 240V / Single / 50			
Cooling	Capacity	Rated	kW	5.3	8.3	
		Min - Max	kW	1.1 - 6.0	3.5 - 9.2	
	Total Input		Rated	kW	1.29	1.90
	Design Load			kW	5.3	8.3
	Annual Electricity Consumption*1			kWh/a	274	398
	SEER*5				6.8	7.3
			Energy Efficiency Class			
				A++	A++	
Heating (Average Season)	Capacity	Rated (7°C)	kW	6.4	9.0	
		Rated (-7°C)	kW	6.4	9.0	
		Rated (-15°C)	kW	6.4	9.0	
		Min - Max	kW	1.0 - 7.0	3.5 - 11.6	
		Total Input	Rated	kW	1.36	1.70
	Design Load			kW	6.4	10.1
	Declared Capacity	at reference design temperature	kW	6.9	10.6	
		at bivalent temperature	kW	7.4	11.5	
		at operation limit temperature	kW	4.1	5.7	
	Back Up Heating Capacity			kW	0.0	0.0
	Annual Electricity Consumption*1			kWh/a	2172	3286
SCOP*5				4.1	4.3	
			Energy Efficiency Class			
				A+	A+	
Max. Operating Current (Indoor+Outdoor)			A	15.6	28.0	
Outdoor Unit	Dimensions		H x W x D	mm	796 x 950 x 330	1048 x 950 x 330
	Weight			kg	61	86
	Air Volume	Cooling		m <sup>3</sup> /min	43	63
		Heating		m <sup>3</sup> /min	41	77
	Sound Level (SPL)	Cooling		dB(A)	45	55
		Heating		dB(A)	47	57
	Sound Level (PWL)	Cooling		dB(A)	55	66
Breaker Size			A	16	30	
Ext. Piping	Diameter		Liquid / Gas	mm	6.35 x 2 / 9.52 x 2	6.35 x 4 / 12.7 x 1 + 9.52 x 3
	Total Piping Length (max)			m	30	70
	Each Indoor Unit Piping Length (max)			m	20	25
	Max. Height			m	15	15
	Chargeless Length			m	30	70
Guaranteed Operating Range [Outdoor]	Cooling		°C	-10 ~ +46	-10 ~ +46	
	Heating		°C	-25 ~ +24	-25 ~ +24	

\*1 Energy consumption based on standard test results.

Actual energy consumption will depend on how the appliance is used and where it is located. \*2 EER/COP, EEL rank, SEER/SCOP values and energy efficiency class are measured when connected to the indoor units listed below.

MXZ-2F53VFHZ2 MSZ-LN18VG2 + MSZ-LN35VG2  
MXZ-4F83VFHZ2 MSZ-LN18VG2 + MSZ-LN18VG2 + MSZ-LN25VG2 + MSZ-LN25VG2

\*3 Indoor unit compatibility table is shown on page 116.

\*4 Refrigerant leakage contributes to climate change. Refrigerant with lower global warming potential (GWP) would contribute less to global warming than a refrigerant with higher GWP, if leaked to the atmosphere. This appliance contains a refrigerant fluid with a GWP equal to 550. This means that if 1 kg of this refrigerant fluid would be leaked to the atmosphere, the impact on global warming would be 550 times higher than 1 kg of CO<sub>2</sub> over a period of 100 years. Never try to interfere with the refrigerant circuit yourself or disassemble the product yourself and always ask a professional. The GWP of R32 is 675 in the IPCC 4th Assessment Report.

\*5 SEER and SCOP are based on 2009/125/EC:Energy-related Products Directive and Regulation(EU) No206/2012.

# MXZ-HA SERIES

Multi-port outdoor units exclusively for MSZ-HR indoor units.



R32

2-port

MXZ-2HA40VF2  
MXZ-2HA50VF2



R32

3-port

MXZ-3HA50VF2

## Stylish Design with Flat Panel Front

A stylish flat panel design is employed for the front of the indoor unit. The simple look matches room aesthetics.



## Easy to create various combinations

Wide range of simple combinations only possible using multi-port outdoor units.

Two bedrooms

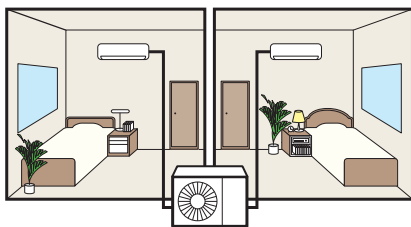

Three bedrooms

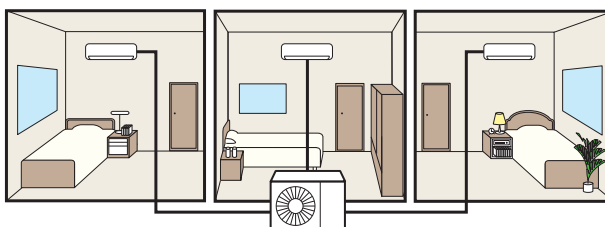

Living room and one bedroom

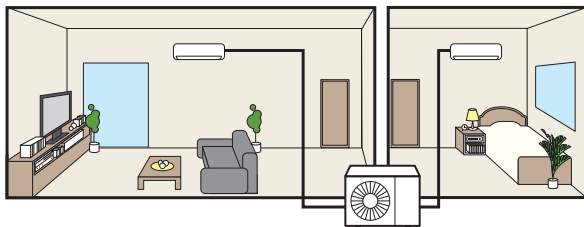

Wide living room

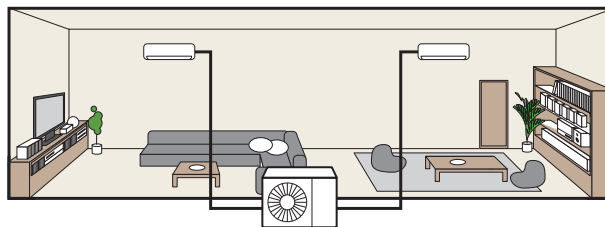

# MXZ-HA SERIES

INVERTER MULTI



Type (Inverter Multi - Split Heat Pump)				Up to 2 Indoor Units		Up to 3 Indoor Units	
Indoor Unit				Please refer to*3			
Outdoor Unit				MXZ-2HA40VF2	MXZ-2HA50VF2	MXZ-3HA50VF2	
Refrigerant				R32			
Power Source				Outdoor power supply			
Supply Outdoor (V/Phase/Hz)				220 - 230 - 240V / Single / 50Hz			
Cooling	Capacity	Rated	kW	4.0	5.0	5.0	
		Min-Max	kW	1.1 - 4.3	1.1 - 5.4	2.9 - 6.5	
	Input	Rated	kW	1.05	1.52	1.26	
	Design Load		kW	4.0	5.0	5.0	
	Annual Electricity Consumption*2		kWh/a	172	225	241	
	SEER*1			8.12	7.78	7.26	
				Energy Efficiency Class*3			
				A++			
Heating	Capacity	Rated	kW	4.3	6.0	6.0	
		Min-Max	kW	1.0 - 4.7	1.0 - 6.4	2.6 - 7.5	
	Input	Rated	kW	0.91	1.54	1.30	
	Design Load		kW	3.2	3.2	4.0	
	Declared Capacity	at reference design temperature	kW	2.4	2.4	3.0	
		at bivalent temperature	kW	2.9	2.9	3.6	
	Back Up Heating Capacity	at operation limit temperature	kW	2.1	2.1	2.6	
			kW	0.8	0.8	1.0	
	Annual Electricity Consumption*2		kWh/a	1043	1043	1394	
	SCOP*3			4.30	4.30	4.02	
				Energy Efficiency Class*3			
				A+			
Max. Operating Current (Indoor+Outdoor)				A	12.2	12.2	18.0
Outdoor Unit	Dimensions	H x W x D	mm	550 - 800 (+69) - 285 (+59.5)		710 - 840 - 330 (+66)	
	Weight		kg	37	37	57	
	Air Volume	Cooling	m <sup>3</sup> /min	28.4	32.7	31.0	
		Heating	m <sup>3</sup> /min	33.5	34.7	29.1	
	Sound Level (SPL)	Cooling	dB(A)	44	47	46	
		Heating	dB(A)	50	51	50	
	Sound Level (PWL)	Cooling	dB(A)	59	64	61	
	Breaker Size		A	15	15	25	
Ext. Piping	Port Diameter	Liquid	mm	6.35 x 2	6.35 x 2	6.35 x 3	
		Gas	mm	9.52 x 2	9.52 x 2	9.52 x 3	
	Total Piping Length (max)		m	30	30	50	
	Each Indoor Unit Piping Length (max)		m	20	20	25	
	Max. Height		m	15(10)*2	15(10)*2	15(10)*2	
Chargeless Length		m	30		40		
Guaranteed Operating Range (Outdoor)	Cooling	°C		-10 ~ +46			
	Heating	°C		-15 ~ +24			
Chargeless Length			R32/675*4	R32/675*4	R32/675*4		
Pre-Charged Quantity	Weight	Kg	0.9	0.9	1.4		
	CO <sub>2</sub> equivalent	t	0.61	0.61	0.95		
Max Added Quantity	Weight	Kg	0.9	0.9	1.6		
	CO <sub>2</sub> equivalent	t	0.61	0.61	1.08		

\*1 Energy consumption based on standard test results.  
 Actual energy consumption will depend on how the appliance is used and where it is located.  
 \*2 If the outdoor unit is installed higher than the indoor unit, max. height is reduced to 10 m.  
 \*3 SEER/SCOP values and energy efficiency class are measured when connected to the indoor units listed below.  
 MXZ-2HA40VF2 → MSZ-HR25VF + MSZ-HR25VF  
 MXZ-2HA50VF2 → MSZ-HR25VF + MSZ-HR25VF  
 MXZ-3HA50VF2 → MSZ-HR25VF + MSZ-HR25VF + MSZ-HR25VF  
 \*4 This GWP value is based on Regulation(EU) No 517/2014 from IPCC 4th edition,

To ensure full capacity in cold and snowy regions...

# 3 Important Points to Remember When Installing the Outdoor Unit



\*RAC/PAC (inc. Air to Water) /MXZ

Wind and snow can significantly reduce capacity.

Be sure to check the information below and install the outdoor unit correctly.

## 1 Installation Location

Be aware of the prevailing wind direction in winter and install the outdoor unit where it is as sheltered as possible.

Units are easily affected by wind and unit may not be able to run at full capacity

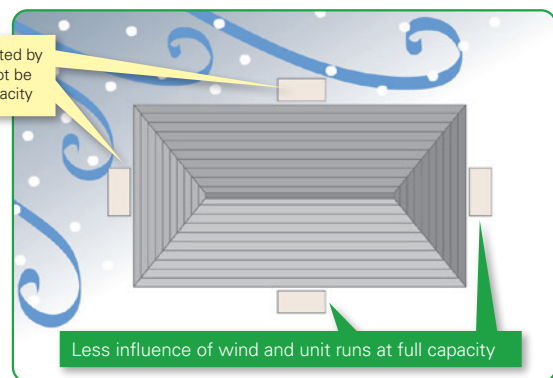

## 2 Measures for Drainage of Water

### Case 1: Unit is installed close to passage (walkway)

Do not install the unit close to passage as drainage water from the unit may freeze and cause a slipping hazard.

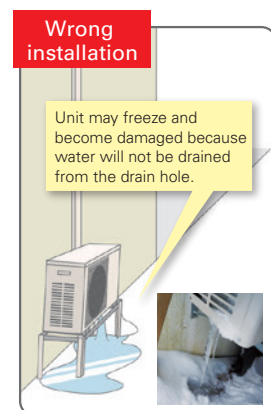
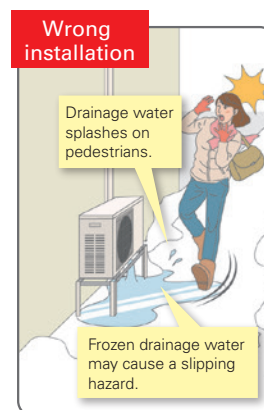
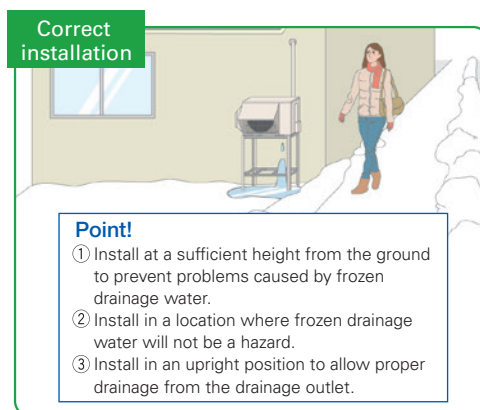

### Case 2: Multiple units are installed

Do not install units on top of one another as it may cause frozen drainage water on the bottom unit.

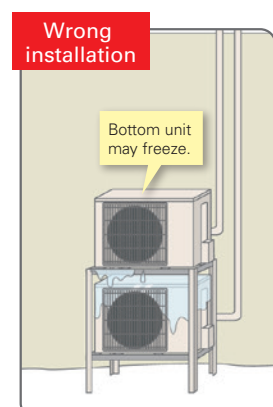
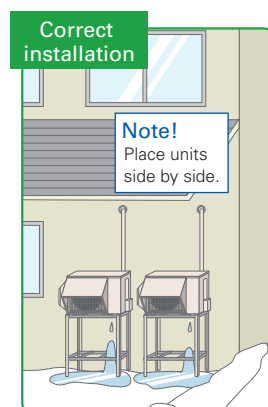

### 3

## Measures for Snow

### Unit is installed on the ground

To avoid the adverse effects of snow and frozen drainage water, install the unit on a stand to ensure a sufficient height from the ground.

[RAC / PAC / MXZ]

**Correct installation**

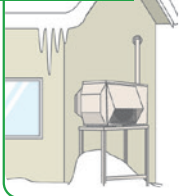

**Point!**

- ① Install at a position/height to prevent the unit being buried in snow\*1 and the adverse effects of frozen drainage water.\*2
- ② Install so as to avoid the effects of snow or snowdrift.
- ③ Install so as to avoid the damage from falling snow or icicles.

\*1 Install at a height above the highest snowfall depth.  
\*2 Even for correct installations, dripping drainage water may form an icicle which needs to be cleared away regularly to prevent a blocked drainage outlet.

**Wrong installation**

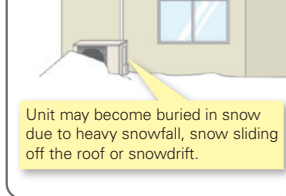

Unit may become buried in snow due to heavy snowfall, snow sliding off the roof or snowdrift.

**Wrong installation**

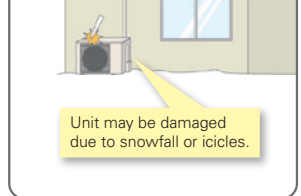

Unit may be damaged due to snowfall or icicles.

Use a stand to add sufficient height to protect the unit heat exchanger from snow and prevent icicles forming during defrost operation.

### Install snow protection hood as necessary

[RAC / PAC / MXZ]

**Correct installation**

Minimum height (h) should be higher than the highest snowfall depth (h0) **+20cm**

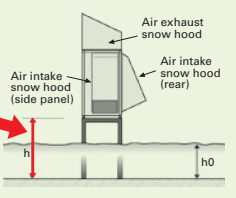

**Wrong installation**

Unit may become covered in snow if the stand height is insufficient.

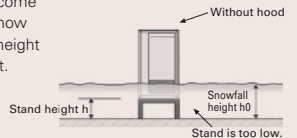

**Correct installation**

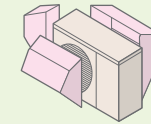

**Point!**

Install the snow protection hood or other cover in snowy regions.

### Necessity of accessories (drain socket & centralised drain pan, stand, snow protection hood, base heater)

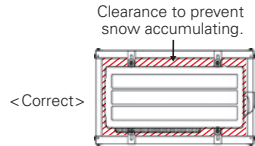
	Snowy region	Cold region	Remarks
	Countermeasures for snow	Countermeasures for freezing	
Drain socket, Centralised drain pan	Not used	Not used	Prevents freezing
Stand	Needed	Needed	[RAC / PAC / MXZ] 1. Install so as to prevent the unit being buried in snow (at a height greater than the highest snowfall depth). Be sure that the stand does not obstruct drainage. 2. Install so as to prevent damage to the unit due to frozen drainage water (icicles). 
Snow protection hood	Needed *When the installation position is subject to snowfall.	—	1. Prevents heat exchanger from being covered in snow. 2. Prevents snow accumulating inside the air duct.
Base heater	—	Needed	[RAC / PAC / MXZ] Outdoor units equipped with a heater for cold regions are those with an "H" in the model name. For the cold-climate zone, use of a unit with a heater is strongly recommended. Even for the moderate-climate zone use of a unit with a heater is recommended for regions subject to high humidity in winter.

### About disposal of drainage water

#### CAUTION

When the unit is installed in cold or snowy regions :

**Drainage water may freeze in the drain socket/hose and prevent the fan from rotating.**



**Do not attach a drain socket packaged as an accessory to the unit.**

\* In the case that fitting a drain socket is absolutely necessary, steps must be taken so that the drainage water does not freeze.  
For more information, please consult Mitsubishi Electric or one of its dealers/resellers.

#### Arrangement for snow protection hood

[RAC / PAC / MXZ]

Separately sold parts are available for some models.

Please consult Mitsubishi Electric or one of its dealers/resellers at the time of purchase for details.

# Indoor Unit Compatibility Table

## ■ MXZ Series **R32**

Possible combinations of outdoor units and indoor units are shown below.

Indoor Unit	Outdoor Unit	Inverter Models Heat Pump Type															
		MXZ <sup>-1</sup> 2F33VF4	MXZ <sup>-1</sup> 2F42VF4	MXZ <sup>-1</sup> 2F53VF(H)4	MXZ <sup>-1</sup> 2F53VFH2	MXZ <sup>-1</sup> 3F54VF4	MXZ <sup>-1</sup> 3F68VF4	MXZ <sup>-1</sup> 4F72VF4	MXZ <sup>-1</sup> 4F80VF4	MXZ <sup>-1</sup> 4F83VF2	MXZ <sup>-1</sup> 4F83VFH2	MXZ <sup>-1</sup> 5F102VF2	MXZ <sup>-1</sup> 6F120VF2	MXZ <sup>-1</sup> 2HA40VF2	MXZ <sup>-1</sup> 2HA50VF2	MXZ <sup>-1</sup> 3HA50VF2	
M series	Wall-Mounted	MSZ-RW25VG	●	●	●	●	●	●	●	●	●	●	●	●			
		MSZ-RW35VG		●	●	●	●	●	●	●	●	●	●	●			
		MSZ-RW50VG					●	●	●	●	●	●	●	●			
		MSZ-LN18VG2(W)(V)(R)(B)	●	●	●	●	●	●	●	●	●	●	●	●			
		MSZ-LN25VG2(W)(V)(R)(B)	●	●	●	●	●	●	●	●	●	●	●	●			
		MSZ-LN35VG2(W)(V)(R)(B)		●	●	●	●	●	●	●	●	●	●	●			
		MSZ-LN50VG2(W)(V)(R)(B)					●	●	●	●	●	●	●	●			
		MSZ-FT25VG				●						●					
		MSZ-FT35VG				●						●					
		MSZ-FT50VG															
		MSZ-AY15VGK(P)	●	●	●	●	●	●	●	●	●	●	●	●			
		MSZ-AY20VGK(P)	●	●	●	●	●	●	●	●	●	●	●	●			
		MSZ-AY25VGK(P)	●	●	●	●	●	●	●	●	●	●	●	●			
		MSZ-AY35VGK(P)		●	●	●	●	●	●	●	●	●	●	●			
		MSZ-AY42VGK(P)			●	●	●	●	●	●	●	●	●	●			
		MSZ-AY50VGK(P)			●	●	●	●	●	●	●	●	●	●			
		MSZ-AP60VG(K)						●	●	●	●	●	●	●			
		MSZ-AP71VG(K)							●	●	●	●	●	●			
		MSZ-EF18VG(K)(W)(B)(S)	●	●	●	●	●	●	●	●	●	●	●	●			
		MSZ-EF22VG(K)(W)(B)(S)	●	●	●	●	●	●	●	●	●	●	●	●			
		MSZ-EF25VG(K)(W)(B)(S)	●	●	●	●	●	●	●	●	●	●	●	●			
		MSZ-EF35VG(K)(W)(B)(S)		●	●	●	●	●	●	●	●	●	●	●			
		MSZ-EF42VG(K)(W)(B)(S)			●	●	●	●	●	●	●	●	●	●			
		MSZ-EF50VG(K)(W)(B)(S)			●	●	●	●	●	●	●	●	●	●			
		MSZ-BT20VG(K)	●	●	●	●	●	●	●	●	●	●	●	●			
		MSZ-BT25VG(K)	●	●	●	●	●	●	●	●	●	●	●	●			
		MSZ-BT35VG(K)		●	●	●	●	●	●	●	●	●	●	●			
		MSZ-BT50VG(K)															
	MSZ-HR25VF(K)													●	●	●	
	MSZ-HR35VF(K)													●	●	●	
	MSZ-HR42VF(K)													●	●	●	
	MSZ-HR50VF(K)															●	
MSZ-HR60VF(K)																	
MSZ-HR71VF(K)																	
MSZ-DW25VF													●	●	●		
MSZ-DW35VF													●	●	●		
MSZ-DW50VF																	
S series	2x2 Cassette	SLZ-M15FA2	●	●	●	●	●	●	●	●	●	●	●				
		SLZ-M25FA2	●	●	●	●	●	●	●	●	●	●	●				
		SLZ-M35FA2		●	●	●	●	●	●	●	●	●	●				
		SLZ-M50FA2					●	●	●	●	●	●	●				
		SLZ-M60FA2						●	●	●	●	●	●				
	Ceiling-Concealed	SEZ-M25DA2 *2	●	●	●	●	●	●	●	●	●	●	●				
		SEZ-M25DAL2 *2	●	●	●	●	●	●	●	●	●	●	●				
		SEZ-M35DA2		●	●	●	●	●	●	●	●	●	●				
		SEZ-M35DAL2		●	●	●	●	●	●	●	●	●	●				
		SEZ-M50DA2					●	●	●	●	●	●	●				
		SEZ-M50DAL2					●	●	●	●	●	●	●				
		SEZ-M60DA2						●	●	●	●	●	●				
		SEZ-M60DAL2						●	●	●	●	●	●				
		SEZ-M71DA2							●	●	●	●	●	●			
	SEZ-M71DAL2								●	●	●	●	●				
	Concealed Floor-Standing	SFZ-M25VA	●	●	●	●	●	●	●	●	●	●	●				
SFZ-M35VA			●	●	●	●	●	●	●	●	●	●					
SFZ-M50VA						●	●	●	●	●	●	●					
SFZ-M60VA							●	●	●	●	●	●					
SFZ-M71VA								●	●	●	●	●					
P series	Ceiling-Suspended	PCA-M50KA2				●	●	●	●								
		PCA-M60KA2					●	●	●								
		PCA-M71KA2						●	●	●							
	Ceiling-Concealed	PEAD-M35JA2					● *3	● *3	● *3	● *3	● *3	● *3	● *3				
		PEAD-M35JAL2					● *3	● *3	● *3	● *3	● *3	● *3	● *3				
		PEAD-M50JA2					● *3	● *3	● *3	● *3	● *3	● *3	● *3				
		PEAD-M50JAL2					● *3	● *3	● *3	● *3	● *3	● *3	● *3				
		PEAD-M60JA2								● *3	● *3	● *3	● *3				
		PEAD-M60JAL2								● *3	● *3	● *3	● *3				
		PEAD-M71JA2									● *3	● *3	● *3	● *3			
		PEAD-M71JAL2									● *3	● *3	● *3	● *3			

\*1 MXZ outdoor units are not designed to operate with a single indoor unit with one-to-one piping work. Please install at least two indoor units.  
 \*2 SEZ-M25 cannot be connected with MXZ-2F/3F/4F when total capacity of connected indoor units is equivalent to outdoor capacity (capacity ratio is 1).  
 \*3 Maximum total current of indoor units: 3A or less  
 \*4 P series cannot be connected with MXZ-4F83VFH2 when ampere limit adjustment function is operated.

# VRF













SERIES





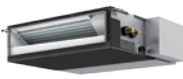

# SELECTION

Choose from types of indoor units and outdoor units.  
Create the system that best matches room shapes and number of rooms.

R410A INDOOR UNITS		R410A OUTDOOR UNITS	
<b>Wall-mounted</b>  MSZ-LN  MSZ-EF  MSZ-AY  MSZ-AP  MSZ-AP  MSZ-BT	<b>Floor-standing</b>  MFZ-KT	<b>PUMY-SP</b>  SP112/125/140V(Y)KM2	
	<b>Ceiling-suspended</b>  PCA		
	<b>Ceiling-concealed</b>  SEZ  PEAD	<b>PUMY-P</b>  P200YKM3  P250/300YBM2	
<b>Cassette</b>  SLZ  MLZ-KP  MLZ-KY			

R32 INDOOR UNITS		R32 OUTDOOR UNITS	
<b>Wall-mounted</b>  MSZ-LN  MSZ-EF  MSZ-AY  MSZ-AP  MSZ-RW  MSZ-BT	<b>Ceiling-suspended</b>  PCA	<b>PUMY-SM</b>  SM112/125/140V(Y)KM	
	<b>Ceiling-concealed</b>  SEZ  PEAD		
<b>Cassette</b>  SLZ  MLZ-KP  MLZ-KY			

## CHECK SYSTEM COMPATIBILITY

Possible combinations depends on the outdoor unit chosen. Please check the following points.

### Check Indoor Units

Refer to the "Indoor Unit Compatibility Table" to check if the indoor units selected can be used with the outdoor unit selected. (Indoor units not listed in the table cannot be used.)

### Check Indoor Unit Capacity Combination

Refer to the "Combination Table" to check if the capacity combination of the indoor unit selected is connectable. (Combinations not listed cannot be connected.)

**If the desired combination cannot be found, please change either the indoor or outdoor unit to match one of the combinations shown in the tables.**

# PUMY-SP SERIES

Air conditioning system supports replacement work by simplifying the installation process. Ideal for supporting renewal needs at small offices and stores, home offices, etc.



R410A

PUMY-SP112/125/140VKM2  
PUMY-SP112/125/140YKM2

## EXAMPLE SYSTEM

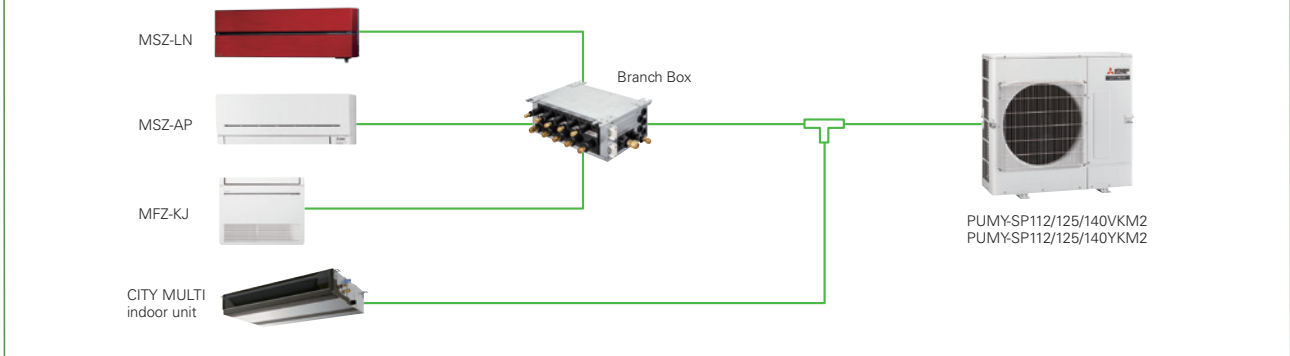

## Light weight and compact size

Compact design fits into narrow outdoor unit space of condominiums and offices. Light weight design facilitates easy installation and transportation.

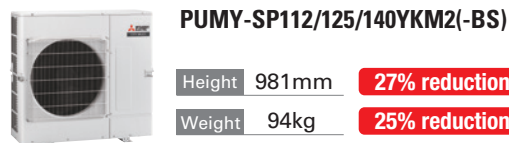
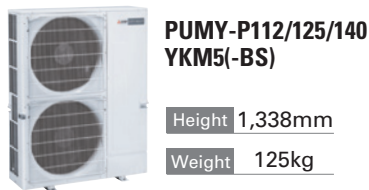

### Unobstructive, compact, and easy to hide from view

Conventional 2-fan type outdoor units may spoil the view. Due to its compact size, the new outdoor fan unit can be installed in locations that would have been inappropriate.

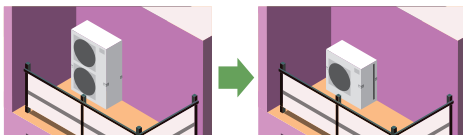

### Easy installation and transportation

The reduced weight and height allow for better transportation performance. Carrying and installing become easier.

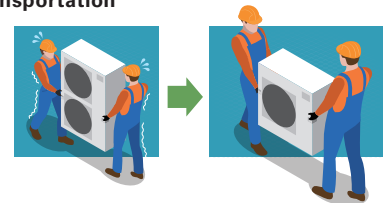

## Industry's top energy efficiency

Even with its compact size and light weight, it has a high EER and COP. Costs are reduced with the industry's best energy saving abilities.

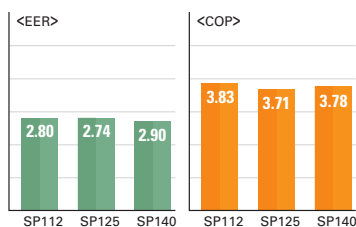

## An external static pressure of 30Pa

The installation location is flexible, thanks to its 30Pa static pressure. You can install it in locations that you could not before.

An external static pressure of 30Pa allows outdoor unit to be installed on balconies in high-rise building or spaces near louvers.

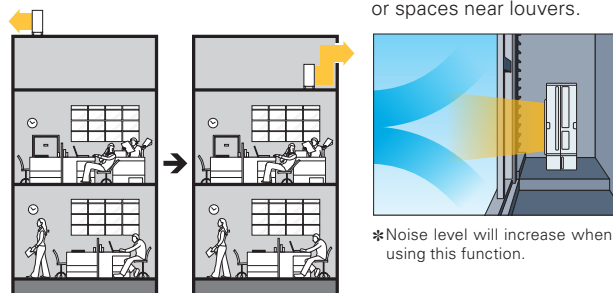

\*Noise level will increase when using this function.

## Super silent mode\*

Noise level can be reduced up to 10dB(A). This allows you to operate the unit even in the night in a residential zone.

\*Capacity reduction differs by mode setting.

\*PAC-SC36NA-E is required to activate Super Silent mode.

## Rear piping is available

### Freedom with layout due to its piping pullout locations in four directions

The in-door unit allows piping from any four directions; front, back, bottom, or right. This enables easier horizontal connection for collective layout.

The out-door unit with an expanded piping layout flexibility greatly improves piping workability.

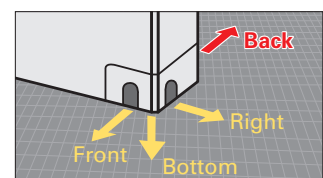

Model	PUMY-SP112VKM2 (-BS)	PUMY-SP125VKM2 (-BS)	PUMY-SP140VKM2 (-BS)	PUMY-SP112YKM2 (-BS)	PUMY-SP125YKM2 (-BS)	PUMY-SP140YKM2 (-BS)	
<b>Power Source</b>	1-phase 220-230-240V 50Hz, 220V 60Hz			3-phase 380-400-415V 50Hz, 380V 60Hz			
<b>Cooling Capacity (Nominal)</b>	Power Input	12.5	14.0	15.5	12.5	14.0	
	Current Input	4.46	5.11	5.34	4.46	5.11	
	EER	20.69 - 19.79 - 18.97, 20.69	23.71 - 22.68 - 21.73, 23.71	24.77 - 23.70 - 22.71, 24.77	7.14 - 6.78 - 6.54, 7.14	8.18 - 7.77 - 7.49, 8.18	8.55 - 8.12 - 7.83, 8.55
	W.B.	2.80	2.74	2.90	2.80	2.74	
<b>Temp. Range of Cooling</b>	Indoor Temp.	15.0-24.0°C (59-75°F)	15.0-24.0°C (59-75°F)	15.0-24.0°C (59-75°F)	15.0-24.0°C (59-75°F)	15.0-24.0°C (59-75°F)	
	Outdoor Temp.*2	D.B. -5.0-52.0°C (23-126°F)	-5.0-52.0°C (23-126°F)	-5.0-52.0°C (23-126°F)	-5.0-52.0°C (23-126°F)	-5.0-52.0°C (23-126°F)	
<b>Heating Capacity (Nominal)</b>	Power Input	14.0	16.0	16.5	14.0	16.0	
	Current Input	3.66	4.31	4.36	3.66	4.31	
	COP	16.98 - 16.24 - 15.57, 16.98	20.00 - 19.13 - 18.33, 20.00	20.23 - 19.35 - 18.54, 20.23	5.86 - 5.57 - 5.36, 5.86	6.90 - 6.55 - 6.32, 6.90	6.98 - 6.63 - 6.39, 6.98
	W.B.	3.83	3.71	3.78	3.83	3.71	
<b>Temp. Range of Heating</b>	Indoor Temp.	15.0-27.0°C (59-81°F)	15.0-27.0°C (59-81°F)	15.0-27.0°C (59-81°F)	15.0-27.0°C (59-81°F)	15.0-27.0°C (59-81°F)	
	Outdoor Temp.	W.B. -20.0-15.0°C (-4-59°F)	-20.0-15.0°C (-4-59°F)	-20.0-15.0°C (-4-59°F)	-20.0-15.0°C (-4-59°F)	-20.0-15.0°C (-4-59°F)	
<b>Indoor Unit Connectable</b>	Total Capacity	50-130 % of outdoor unit capacity					
	Model / Quantity	City Multi*4	10-140/12	10-140/12	10-140/12	10-140/12	10-140/12
	Mixed System	Branch Box*5	15-100/8	15-100/8	15-100/8	15-100/8	15-100/8
		City Multi	10-140/5	10-140/5	10-140/5	10-140/5	10-140/5
		Branch Box*6	15-100/5	15-100/5	15-100/5	15-100/5	15-100/5
		City Multi	10-140/3	10-140/3	10-140/3	10-140/3	10-140/3
Branch Box*5		15-100/8	15-100/8	15-100/8	15-100/8	15-100/8	
<b>Sound Pressure Level (Measured In Anechoic Room)</b>	dB <A>	52/54	53/56	54/56	52/54	53/56	
<b>Sound Power Level (Measured In Anechoic Room)</b>	dB <A>	72/74	73/76	74/76	72/74	73/76	
<b>Refrigerant Piping Diameter</b>	Liquid Pipe	9.52 (3/8)	9.52 (3/8)	9.52 (3/8)	9.52 (3/8)	9.52 (3/8)	
	Gas Pipe	15.88 (5/8)	15.88 (5/8)	15.88 (5/8)	15.88 (5/8)	15.88 (5/8)	
<b>Fan</b>	Type x Quantity	Propeller Fan x 1					
	Air Flow Rate	m <sup>3</sup> /min	77	83	83	77	83
		L/s	1,283	1,383	1,383	1,283	1,383
		cfm	2,719	2,931	2,931	2,719	2,931
	Motor Output	kW	0.20 x 1	0.20 x 1	0.20 x 1	0.20 x 1	0.20 x 1
External Static Press.	0Pa / 30Pa*6	0Pa / 30Pa*6	0Pa / 30Pa*6	0Pa / 30Pa*6	0Pa / 30Pa*6	0Pa / 30Pa*6	
<b>Compressor</b>	Type x Quantity	Twin rotary hermetic compressor x 1					
	Starting Method	Inverter					
	Motor Output	kW	3.9	3.9	4.2	3.9	4.1
<b>External dimension H x W x D</b>	mm	981 x 1,050 x 330 (+40)					
	in.	38-5/8 x 41-3/8 x 13 (+1-37/64)					
<b>Net Weight</b>	kg (lbs)	93 (205)*7			94 (207)*8		

\*1, \*3 Nominal conditions

	Indoor	Outdoor	Piping Length	Level Difference	External Static Press. (Outdoor Unit)
<b>Cooling</b>	27°C DB / 19°C WB	35°C	7.5m (24 - 9' 16ft.)	0m (0ft)	0 Pa
<b>Heating</b>	20°C DB	7°C DB / 6°C WB	7.5m (24 - 9' 16ft.)	0m (0ft)	0 Pa

\*2 10 to 52°C; In case of connecting PKFY-P15/P20/P25VBM, PKFY-P10/15/20/25/32VLM, PFFY-P20/P25/P32VKM, PFFY-P20/25/32VCM, PFFY-P20/P25/P32VLE(R)M indoor unit and M series indoor unit with connection kit and M series, S series, and P series type indoor unit with branch box.

\*4 It is possible to connect 1 Fresh Air type indoor unit to 1 outdoor unit. (1:1 system)

\*5 At least 2 indoor units must be connected when using branch box.

\*6 0 Pa as initial setting

\*7 94 (207), for PUMY-SP112/125/140YKM2-BS

\*8 95 (209), for PUMY-SP112/125/140YKM2-BS

Type	Branch Box				
Model Name	PAC-MK54BC	PAC-MK34BC			
Connectable Number of Indoor Units	Maximum 5	Maximum 3			
Power Supply (from outdoor unit)	~ / N, 220 / 230 / 240 V, 50 Hz, ~ / N, 220 / 230 V, 60 Hz				
Input	kW				
Running Current	A				
Dimensions	H x W x D				
Weight	kg				
Piping Connection (Flare)	Branch [Indoor Side]	Liquid	mm	ø6.35 x 5	ø6.35 x 3
		Gas	mm	ø9.52 x 4, ø12.7 x 1	ø9.52 x 3
	Main [Outdoor Side]	Liquid	mm	ø9.52	
		Gas	mm	ø15.88	

\* The piping connection size differs according to the type and capacity of outdoor/indoor units. Match the piping connection size of branch box with outdoor/indoor unit. If the piping connection size of branch box does not match the piping connection size of outdoor/indoor unit, use optional different-diameter (deformed) joints to the branch box side. (Connect deformed joint directly to the branch box side.)

**<Branch box compatible table>**

Outdoor unit		Branch box	PAC-MK31/51BC(B)	PAC-MK32/52BC(B)	PAC-MK33/53BC(B)	PAC-MK33/54BC
Outdoor unit 1fan	PUMY-SP112/125/140V/YKM2(-BS)		N/A	N/A	✓*	✓*
Outdoor unit 2fan	PUMY-P112/125/140VKM6(-BS)		N/A	N/A	✓	✓
	PUMY-P112/125/140YKM5(-BS)		N/A	N/A	✓	✓
	PUMY-P200YKM3(-BS)		N/A	N/A	✓*	✓*
	PUMY-P250/300YBM2(-BS)		N/A	N/A	✓*	✓*

\*ecodan is NG

**[SP112-140V/YKM2(-BS)]**

Refrigerant Piping Lengths	Maximum meters	Vertical differentials between units	Maximum meters
Total length	120	Indoor/outdoor (outdoor higher)	50
Maximum allowable length	To City Multi indoor unit: 70	Indoor/outdoor (outdoor lower)	30
	Through Branch box: 80	Indoor/indoor	15*

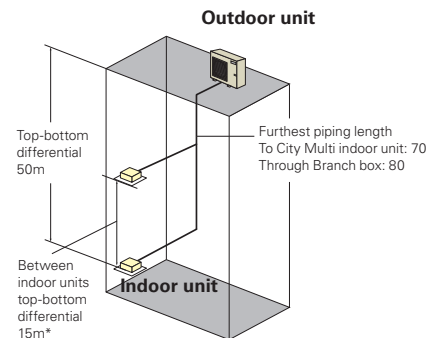

\*In case of branch box connection: 12m

# PUMY-P SERIES

Air conditioning system supports replacement work by simplifying the installation process. Ideal for supporting renewal needs at small offices and stores, home offices, etc.



**R410A**

PUMY-P112/125/140VKM6  
PUMY-P112/125/140YKM5  
PUMY-P200YKM3  
PUMY-P250/300YBM2

## EXAMPLE SYSTEM

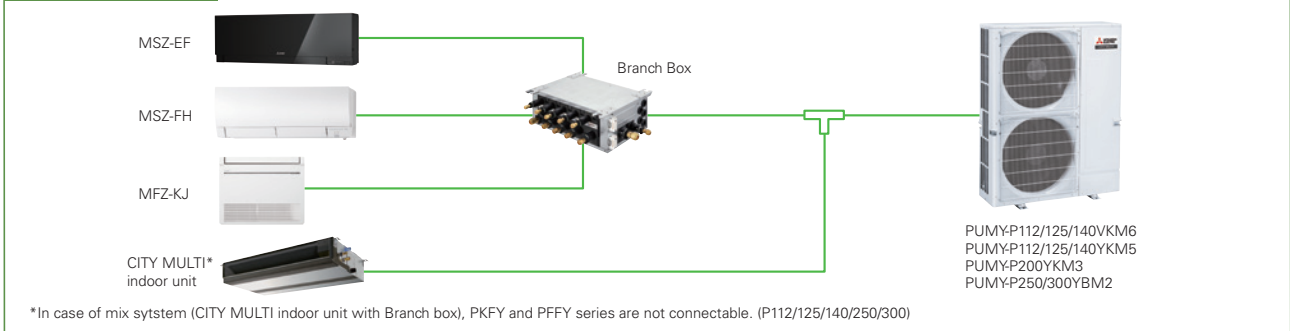

## The two-pipe zoned system designed for Heat Pump Operation

PUMY series make use of a two-pipe refrigerant system, which allows for system changeover from cooling to heating, ensuring that a constant indoor climate is maintained in all zones. The compact outdoor unit utilizes R410A refrigerant and an INVERTER-driven compressor to use energy effectively.

With a wide range of indoor unit line-up in connection with a flexible piping system, PUMY series can be configured for all applications. Up to 12 (P250/300: Up to 30) indoor units can be connected with up to 130% connected capacity to maximize engineer's design options. This feature allows easy air conditioning in each area with convenient individual controllers.

### Small Offices

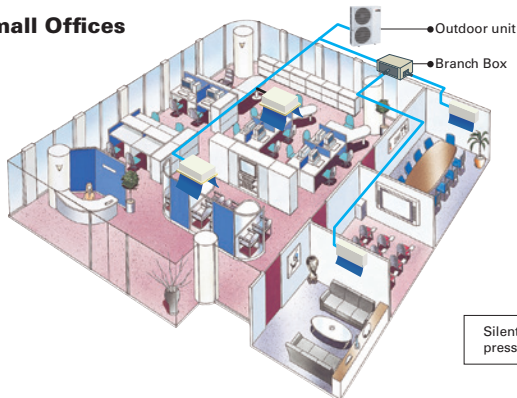

### Residence

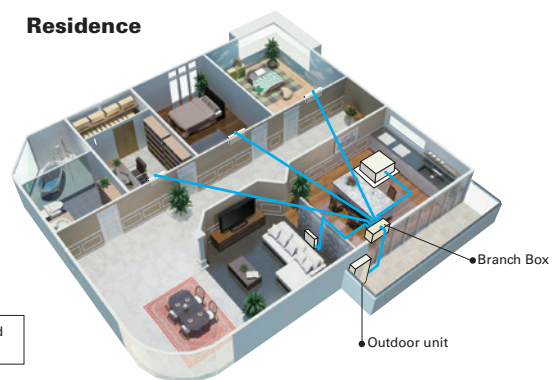

Silent mode can reduce sound pressure level by 3dB(A)

		Maximum Meters			
		Only City Multi*1 Indoor Unit	Only Branch Box Connection	Mixed System (City Multi*1 Indoor Unit + Branch Box)	
P112/125/140	Refrigerant Piping Length	Total Length	300	150	240 (2 Branch boxes) / 300 (1 Branch box)
		Maximum Allowable Length	150 (175 equivalent)	80	85 (95 equivalent)
		Farthest Indoor From First Branch	30	30	30
		Piping Length Between Outdoor Unit and Branch Boxes	55	55	55
	Vertical Differentials Between Units	Indoor/Outdoor (Outdoor higher)	50	50	50
		Indoor/Outdoor (Outdoor Lower)	40*2	40	40
		Indoor/Indoor	15	12	12
P200	Refrigerant Piping Length	Total Length	150	150	150
		Maximum Allowable Length	80 (90 equivalent)	80	80 (90 equivalent)
		Farthest Indoor From First Branch	30	30	30
		Piping Length Between Outdoor Unit and Branch Boxes	55	55	55
	Vertical Differentials Between Units	Indoor/Outdoor (Outdoor higher)	50	50	50
		Indoor/Outdoor (Outdoor Lower)	40	40	40
		Indoor/Indoor	15	12	12
P250/300	Refrigerant Piping Length	Total Length	310	240	310
		Maximum Allowable Length	150 (175 equivalent)	80	85 (95 equivalent)
		Farthest Indoor From First Branch	30	30	30
		Piping Length Between Outdoor Unit and Branch Boxes	95	95	95
	Vertical Differentials Between Units	Indoor/Outdoor (Outdoor higher)	50	50	50
		Indoor/Outdoor (Outdoor Lower)	40	40	40
		Indoor/Indoor	15	12	12

\*1 Include system with connection kit \*2 In case of including PKFY or PFFY, height between units is 30m.

## 30Pa external static pressure\* Option (requires PAC-SJ71FM-E)

An external static pressure of 30Pa enables the outdoor unit to be installed on balconies in high-rise building or spaces near louvers.

\* PUMY-P112/125/140VKM6(-BS), PUMY-P112/125/140YKM5(-BS) only.  
\* Noise level will increase when using this function.

30Pa external static pressure fan motor (option)  
(PAC-SJ71FM-E)

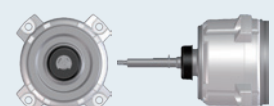

# PUMY-P SERIES

INVERTER MULTI



Model		PUMY-P112VKM6 (-BS)	PUMY-P125VKM6 (-BS)	PUMY-P140VKM6 (-BS)	PUMY-P112YKM6 (-BS)	PUMY-P125YKM6 (-BS)	PUMY-P140YKM6 (-BS)	PUMY-P200YKM3 (-BS)	PUMY-P250YBM2 (-BS)	PUMY-P300YBM2 (-BS)	
<b>Power Source</b>		1-phase 220-230-240V 50Hz, 220-230V 60Hz			3-phase 380-400-415V 50Hz, 380V 60Hz			3-phase 380-400-415V 50Hz			
<b>Cooling Capacity (Nominal)</b>	<b>Power Input</b> **	kW	12.5	14.0	15.5	12.5	14.0	15.5	22.4	28.0	33.5
	<b>Current Input</b>	A	4.34	5.00	5.17	4.34	5.00	5.17	7.18	8.21	11.96
	<b>EER</b>	kW/kW	2.88	2.80	3.00	2.88	2.80	3.00	3.12	3.41	3.41
<b>Temp. Range of Cooling</b>	<b>Indoor Temp.</b> **	W.B.	15.0-24.0°C (59-75°F)	15.0-24.0°C (59-75°F)	15.0-24.0°C (59-75°F)	15.0-24.0°C (59-75°F)	15.0-24.0°C (59-75°F)	15.0-24.0°C (59-75°F)	15.0-24.0°C (59-75°F)	15.0-24.0°C (59-75°F)	15.0-24.0°C (59-75°F)
	<b>Outdoor Temp.</b> **	D.B.	-5.0-52.0°C (23-126°F)	-5.0-52.0°C (23-126°F)	-5.0-52.0°C (23-126°F)	-5.0-52.0°C (23-126°F)	-5.0-52.0°C (23-126°F)	-5.0-52.0°C (23-126°F)	-5.0-52.0°C (23-126°F)	-5.0-52.0°C (23-126°F)	-5.0-52.0°C (23-126°F)
<b>Heating Capacity (Nominal)</b>	<b>Power Input</b> **	kW	14.0	16.0	16.0	14.0	16.0	16.0	25.0	31.5	37.5
	<b>Current Input</b>	A	3.49	4.06	4.63	3.49	4.06	4.63	5.85	7.91	9.69
	<b>COP</b>	kW/kW	4.01	3.94	3.89	4.01	3.94	3.89	4.27	3.98	3.87
<b>Temp. Range Of Heating</b>	<b>Indoor Temp.</b>	D.B.	15.0-27.0°C (59-81°F)	15.0-27.0°C (59-81°F)	15.0-27.0°C (59-81°F)	15.0-27.0°C (59-81°F)	15.0-27.0°C (59-81°F)	15.0-27.0°C (59-81°F)	15.0-27.0°C (59-81°F)	15.0-27.0°C (59-81°F)	15.0-27.0°C (59-81°F)
	<b>Outdoor Temp.</b>	W.B.	-20.0-15.0°C (4-59°F)	-20.0-15.0°C (4-59°F)	-20.0-15.0°C (4-59°F)	-20.0-15.0°C (4-59°F)	-20.0-15.0°C (4-59°F)	-20.0-15.0°C (4-59°F)	-20.0-15.0°C (4-59°F)	-20.0-15.0°C (4-59°F)	-20.0-15.0°C (4-59°F)
<b>Indoor Unit Connectable</b>	<b>Total Capacity</b>		50-130 % of outdoor unit capacity	50-130 % of outdoor unit capacity	50-130 % of outdoor unit capacity	50-130 % of outdoor unit capacity	50-130 % of outdoor unit capacity	50-130 % of outdoor unit capacity	50-130 % of outdoor unit capacity	50-130 % of outdoor unit capacity	
	<b>Model / Quantity</b>		10-140/10	10-140/10	10-140/12	10-140/9	10-140/12	10-140/12	10-250/30	10-250/30	
<b>Mixed System</b>	<b>Branch Box</b>	<b>Branch Box 1 unit</b>	City Multi**	15-100/8	15-100/8	15-100/8	15-100/8	15-100/8	15-100/8	15-50/12	15-50/12
		<b>Branch Box 2 units</b>	City Multi	10-140/5	10-140/5	10-140/5	10-140/5	10-140/5	10-200/5	10-250/25	10-250/25
		<b>Branch Box 3 units</b>	City Multi	15-100/5	15-100/5	15-100/5	15-100/5	15-100/5	15-100/5	15-100/5	15-100/5
		City Multi	10-140/3 or 2**	10-140/3	10-140/3	10-140/3	10-140/3	10-200/3	10-250/23	10-250/23	
		City Multi	15-100/7 or 8**	15-100/8	15-100/8	15-100/8	15-100/8	15-100/8	15-50/10	15-50/10	
		City Multi	-	-	-	-	-	-	10-250/22	10-250/22	
		City Multi	-	-	-	-	-	-	-	-	
		City Multi	-	-	-	-	-	-	-	-	
		City Multi	-	-	-	-	-	-	-	-	
		City Multi	-	-	-	-	-	-	-	-	
City Multi	-	-	-	-	-	-	-	-			
<b>Sound Pressure Level (Measured In Anechoic Room)</b>			49/51	50/52	51/53	49/51	50/52	51/53	57/61	55/61	57/62
<b>Sound Power Level (Measured In Anechoic Room)</b>			69/71	70/72	71/73	69/71	70/72	71/73	76/80	74/79	75/79
<b>Refrigerant Piping Diameter</b>			9.52 (3/8)	9.52 (3/8)	9.52 (3/8)	9.52 (3/8)	9.52 (3/8)	9.52 (3/8)	9.52 (3/8)**	9.52 (3/8)**	12.7 (1/2)
<b>Fan</b>	<b>Liquid Pipe</b>	mm (in.)	15.88 (5/8)	15.88 (5/8)	15.88 (5/8)	15.88 (5/8)	15.88 (5/8)	15.88 (5/8)	19.05 (4/3)	19.05 (4/3)	22.4 (7/8)
	<b>Gas Pipe</b>	mm (in.)	15.88 (5/8)	15.88 (5/8)	15.88 (5/8)	15.88 (5/8)	15.88 (5/8)	15.88 (5/8)	19.05 (4/3)	19.05 (4/3)	22.4 (7/8)
	<b>Type x Quantity</b>		Propeller Fan x 2	Propeller Fan x 2	Propeller Fan x 2	Propeller Fan x 2	Propeller Fan x 2	Propeller Fan x 2	Propeller Fan x 2	Propeller Fan x 2	Propeller Fan x 2
	<b>Air Flow Rate</b>										
	<b>Motor Output</b>										
<b>Compressor</b>	<b>Type x Quantity</b>		Scroll hermetic compressor x 1								
	<b>Starting Method</b>		Inverter								
	<b>Motor Output</b>	kW	2.9	3.5	3.9	2.9	3.5	3.9	5.3	8.87	10.15
<b>External Dimension H x W x D</b>		mm	1,338 x 1,050 x 330 (+40)						1,662 x 1,050 x 460 (+45)		
		in.	52-11/16 x 41-11/32 x 13 (+1-9/16)						65-7/16 x 41-11/32 x 187/64 (+1-9/64)		
<b>Net Weight</b>	kg (lbs)	123 (271)			125 (276)			141 (311)		192 (423)	

\*1, \*4 Nominal conditions

	Indoor	Outdoor	Piping Length	Level Difference
<b>Cooling</b>	27°C DB / 19°C WB	35°C	7.5m	0m
<b>Heating</b>	20°C DB	7°C DB / 6°C WB	7.5m	0m

\*2 10 to 52°C D.B.: When connecting PKFY-P10/15/20/25/32VLM, PKFY-P15/20/25VBM, PFFY-P20/25/32VKM and PFFY-P20/25/32VLE(R)M, PFFY-PVMA3, M, S and P series indoor unit.

\*3 When connecting 7 indoor units via branch box, connectable City Multi indoor units are 3; connecting 8 indoor units via branch box, connectable indoor units are 2.

\*5 It is possible to connect 1 Fresh Air type indoor unit to 1 outdoor unit. (1:1 system)

\*6 At least 2 indoor units must be connected when using branch box.

\*7 Liquid pipe diameter: 12.7mm when piping length is more than 60m.

\*8 Liquid pipe diameter: 12.7mm, when further piping length is longer than 90m, and when PEFYP200 or P250 is connected.

Type	Branch Box				
<b>Model Name</b>	PAC-MK54BC	PAC-MK34BC			
<b>Connectable Number of Indoor Units</b>	Maximum 5	Maximum 3			
<b>Power Supply (from outdoor unit)</b>	~ / N, 220 / 230 / 240 V, 50 Hz, ~ / N, 220 / 230 V, 60 Hz				
<b>Input</b>	kW				
	0.003				
<b>Running Current</b>	A				
	0.05 (Max. 6)				
<b>Dimensions</b>	H x W x D				
	mm				
	170 x 450 x 280				
<b>Weight</b>	kg				
	7.4				
<b>Piping Connection (Flare)</b>	<b>Branch</b> [Indoor Side]	Liquid	mm	ø6.35 x 5	ø6.35 x 3
		Gas	mm	ø9.52 x 4, ø12.7 x 1	ø9.52 x 3
	<b>Main</b> [Outdoor Side]	Liquid	mm	ø9.52	
		Gas	mm	ø15.88	

\* The piping connection size differs according to the type and capacity of outdoor/indoor units. Match the piping connection size of branch box with outdoor/indoor unit. If the piping connection size of branch box does not match the piping connection size of outdoor/indoor unit, use optional different-diameter (deformed) joints to the branch box side. (Connect deformed joint directly to the branch box side.)

# PUMY-SM SERIES



R32

PUMY-SM112/125/140VKM  
PUMY-SM112/125/140YKM

Air conditioning system supports replacement work by simplifying the installation process. Ideal for supporting renewal needs at small offices and stores, home offices, etc.

## System of R32 PUMY

### Branch box system

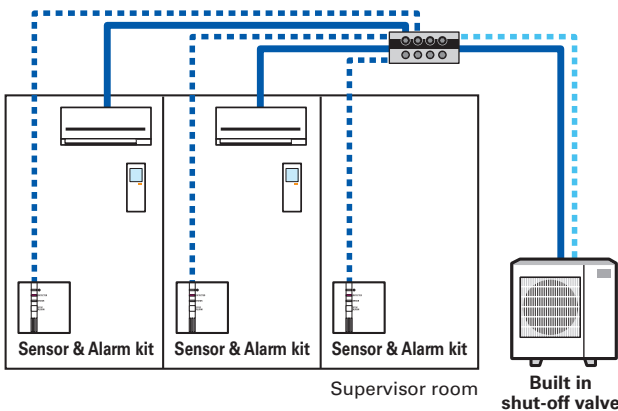

### Free plan system

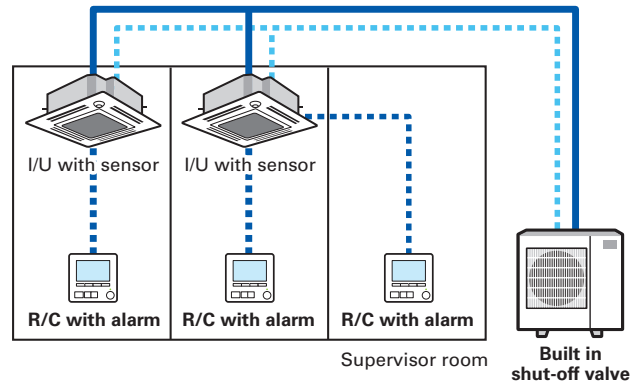

\* Solid lines are refrigerant piping. Dotted lines are communication lines.

## Summary of System component

### S&A kit • Remote controller

	Appearance	System	Features
S&A kit		• Branch box	<ul style="list-style-type: none"> <li>• Connected from branch box</li> <li>• Sensor and alarm in the device</li> <li>• Have 3 types of LED (operation, detection, error)</li> <li>• Detection of refrigerant leakage, a kit alerts and LED flashes in red</li> <li>• Alarm can be stopped only by a kit in a room that refrigerant leakage occurred</li> </ul>
Remote controller		• Free Plan	<ul style="list-style-type: none"> <li>• Connected from indoor unit</li> <li>• Alarm in the device</li> <li>• Have a display</li> <li>• In case of refrigerant leakage, R/C alerts and error code and address of indoor unit is shown</li> <li>• Alarm can be stopped by a R/C in a room that refrigerant leakage occurred and a supervisor room</li> </ul>

\* Can be used as a Wired remote control in a Branch box system. However, in this case, a separate S/A kit connection is required.

### Branch box

Model name	PAC-MMK40BC(B)	PAC-MMK60BC	
Number of ports	4 ports	6 ports	
Refrigerant	R32	R32	
Input(kW)	0.003	0.006	
Running current(A)	0.15	0.30	
Size(mm)			
H	170	170	
W	450	665	
D	372	420	
Installation			
Ceiling-suspended	✓	✓	
Floor-standing	✓	✓	
Vertical	✓	✓	
No need drainpan	✓	✓	
Connection			
Flare connection	✓	✓	
Blazing	✓	—	
Branch Piping(g)			1st 6.35/9.52 2nd 6.35/9.52 3rd 6.35/12.7 4th 6.35/9.52 5th 6.35/9.52 6th 9.52/15.88
Piping/Wiring			• Piping connection from both side and wiring connection from one side. • If necessary, you need to flip over only electrical box to connect from the other side.
Instability			• Possible to make piping connection from both side. • Flipping over only electrical box is not difficult for installer. • #9.52/15.88 can be connected to a large indoor unit placed in a living room or other large room.

## Energy efficiency

Even with its compact size and light-weight, it has a high EER and COP. Costs are reduced with the energy saving abilities.

\* Temperature conditions

EER : Indoor 27°C DB / Outdoor 35°C DB

COP : Indoor 20°C DB / Outdoor 7°C DB

SCOP/SEER: Based on ErP Lot 21/6 calculation method to EN14825.

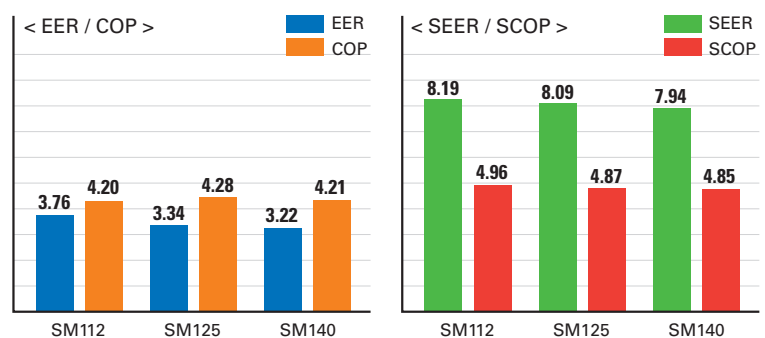

## Super silent mode\*

- Noise level can be reduced up to 10dB(A).
- This allows you to operate the unit even in the night in a residential zone.

\* Capacity reduction differs by mode setting.

\* PAC-SC36NA-E is required to activate Super Silent mode.

\* Cooling mode only.

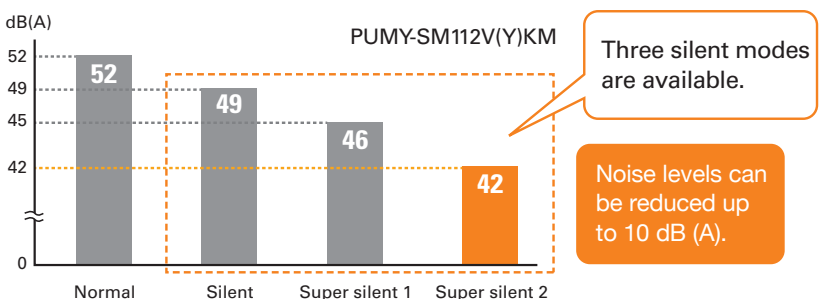



Model		PUMY-SM112VKM	PUMY-SM125VKM	PUMY-SM140VKM	PUMY-SM112YKM	PUMY-SM125YKM	PUMY-SM140YKM	
<b>Power source</b>		1-phase 220-230-240V 50Hz, 220V 60Hz			3-phase 380-400-415V 50Hz, 380V 60Hz			
<b>Cooling Capacity (Nominal)</b>	kW	12.5	14.0	15.5	12.5	14.0	15.5	
	Power Input kW	3.32	4.19	4.81	3.32	4.19	4.81	
	Current Input A	15.40 - 14.73 - 14.12 / 15.40	19.43 - 18.59 - 17.81 / 19.43	22.45 - 21.47 - 20.58 / 22.45	5.31 - 5.04 - 4.86 / 5.31	6.70 - 6.37 - 6.14 / 6.70	7.74 - 7.35 - 7.09 / 7.74	
	EER kW / kW	3.76	3.34	3.22	3.76	3.34	3.22	
<b>Temp. Range of Cooling</b>	Indoor Temp.*1	W.B. 15.0-24.0°C (59-75°F)	15.0-24.0°C (59-75°F)	15.0-24.0°C (59-75°F)	15.0-24.0°C (59-75°F)	15.0-24.0°C (59-75°F)	15.0-24.0°C (59-75°F)	
	Outdoor Temp.**2,3	D.B. -5.0-52.0°C (23-126°F)	-5.0-52.0°C (23-126°F)	-5.0-52.0°C (23-126°F)	-5.0-52.0°C (23-126°F)	-5.0-52.0°C (23-126°F)	-5.0-52.0°C (23-126°F)	
<b>Heating Capacity (Nominal)</b>	kW	14.0	16.0	17.5	14.0	16.0	17.5	
	Power Input kW	3.33	3.74	4.16	3.33	3.74	4.16	
	Current Input A	15.45 - 14.77 - 14.16 / 15.45	17.30 - 16.55 - 15.86 / 17.30	19.25 - 18.41 - 17.64 / 19.25	5.33 - 5.06 - 4.88 / 5.33	5.97 - 5.67 - 5.46 / 5.97	6.64 - 6.31 - 6.08 / 6.64	
	COP kW / kW	4.20	4.28	4.21	4.20	4.28	4.21	
<b>Temp. Range of Heating</b>	Indoor Temp.	D.B. 15.0-27.0°C (59-81°F)	15.0-27.0°C (59-81°F)	15.0-27.0°C (59-81°F)	15.0-27.0°C (59-81°F)	15.0-27.0°C (59-81°F)	15.0-27.0°C (59-81°F)	
	Outdoor Temp.	W.B. -20.0-15.0°C (-4-59°F)	-20.0-15.0°C (-4-59°F)	-20.0-15.0°C (-4-59°F)	-20.0-15.0°C (-4-59°F)	-20.0-15.0°C (-4-59°F)	-20.0-15.0°C (-4-59°F)	
<b>Indoor Unit Connectable</b>	<b>Total Capacity</b>		50-130 % of outdoor unit capacity	50-130 % of outdoor unit capacity	50-130 % of outdoor unit capacity	50-130 % of outdoor unit capacity	50-130 % of outdoor unit capacity	
	<b>Model / Quantity</b>							
	Branch box 1unit	City Multi	10-140/12	10-140/12	10-140/12	10-140/12	10-140/12	10-140/12
		Branch Box	15-100/8	15-100/8	15-100/8	15-100/8	15-100/8	15-100/8
		City Multi	10-140/3 or 5**4	10-140/3 or 5**4	10-140/3 or 5**4	10-140/3 or 5**4	10-140/3 or 5**4	10-140/3 or 5**4
		Branch Box	15-100/4 or 6**5	15-100/4 or 6**5	15-100/4 or 6**5	15-100/4 or 6**5	15-100/4 or 6**5	15-100/4 or 6**5
City Multi		10-140/2 or 3**6	10-140/2 or 3**6	10-140/2 or 3**6	10-140/2 or 3**6	10-140/2 or 3**6	10-140/2 or 3**6	
Branch box 2unit	Branch Box	15-100/8	15-100/8	15-100/8	15-100/8	15-100/8		
<b>Sound Pressure Level (Cooling/Heating)</b>	dB <A>	52/54	53/56	54/56	52/54	53/56	54/56	
<b>Sound Power Level (Cooling/Heating)</b>	dB <A>	72/74	74/76	74/76	72/74	74/76	74/76	
<b>Refrigerant Piping Diameter</b>	Liquid Pipe mm (in.)	9.52 Flare	9.52 Flare	9.52 Flare	9.52 Flare	9.52 Flare	9.52 Flare	
	Gas Pipe mm (in.)	15.88 Flare	15.88 Flare	15.88 Flare	15.88 Flare	15.88 Flare	15.88 Flare	
<b>Fan</b>	<b>Type x Quantity</b>		Propeller Fan x 1	Propeller Fan x 1	Propeller Fan x 1	Propeller Fan x 1	Propeller Fan x 1	
	<b>Air Flow Rate</b>	m <sup>3</sup> /min	77	83	83	77	83	
		L/s	1,283	1,383	1,383	1,283	1,383	
		cfm	2,719	2,931	2,931	2,719	2,931	
	<b>Motor Output</b>	kW	0.20 x 1	0.20 x 1	0.20 x 1	0.20 x 1	0.20 x 1	
<b>External Static Press.</b>		0Pa / 30Pa**7	0Pa / 30Pa**7	0Pa / 30Pa**7	0Pa / 30Pa**7	0Pa / 30Pa**7	0Pa / 30Pa**7	
<b>Compressor</b>	<b>Type x Quantity</b>		Twin rotary hermetic compressor x 1					
	<b>Starting Method</b>		Inverter					
	<b>Motor Output</b>	kW	2.3	2.6	3.0	2.3	2.6	3.0
<b>External Dimension H x W x D</b>	mm	981 x 1,050 x 330 (+40)						
	in.	38-5/8 x 41-3/8 x 13 (+1-37/64)						
<b>Net Weight</b>	kg (lbs)	95 (209)**8			97(214) **9			
<b>Pre-Charged Quantity</b>	Weight kg	3.0	3.0	3.0	3.0	3.0	3.0	
	CO <sub>2</sub> equivalent t	2.03	2.03	2.03	2.03	2.03	2.03	
<b>Max System Quantity</b>	Weight kg	7.5	7.5	7.5	7.5	7.5	7.5	
	CO <sub>2</sub> equivalent t	5.06	5.06	5.06	5.06	5.06	5.06	

\*1 15 to 23°C when using branch box(M/S/P series)

\*2 10 to 52°C: in case of connecting PKFY-MS\*VKM, PKFY-MS\*VLM indoor unit and M series, S series and P series type indoor unit with branch box.

\*3 -15 to 52°C: when using an optional air protect guide [PAC-SH95AG-E]. However, this condition does not apply to the indoor unit listed in\*1.

\*4 When connected branch box is PAC-MMK60BC, connectable City Multi indoor units are 3; connected branch box is PAC-MMK40BC(B), connectable City Multi indoor units are 5.

\*5 When connected branch box is PAC-MMK40BC(B), connectable indoor units via branch box are 4; connected branch box is PAC-MMK60BC, connectable indoor units via branch box are 6.

\*6 When connected branch boxes are PAC-MMK40BC(B) and PAC-MMK60BC, connectable City Multi indoor units are 2; connected branch boxes are PAC-MMK40BC(B) and PAC-MMK40BC(B), connectable City Multi indoor units are 3; connected branch boxes are PAC-MMK60BC and PAC-MMK60BC are not allowed.

\*7 0 Pa as initial setting

\*8 96 (212), for PUMY-SM112/125/140VKM-BS

\*9 98 (216), for PUMY-SM112/125/140YKM-BS

### Indoor unit connectable table

Model		PUMY-SM112V(Y)KM	PUMY-SM125V(Y)KM	PUMY-SM140V(Y)KM
<b>CM Indoor Only</b>		12	12	12
<b>Branch Box Only</b>		8	8	8
<b>Mix System</b>	CM Indoor	3	3	3
	Branch Box	6	6	6
<b>PAC-MMK60BC</b>		9	9	9
<b>Mix System</b>	CM Indoor	5	5	5
	Branch Box	4	4	4
<b>PAC-MMK40BC(B)</b>		9	9	9
<b>Mix System</b>	CM Indoor	2	2	2
	Branch Box	8	8	8
<b>PAC-MMK60BC + PAC-MMK40BC(B)</b>		10	10	10
<b>Mix System</b>	CM Indoor	3	3	3
<b>Branch Box 2unit</b>	Branch Box	8	8	8
	PAC-MMK40BC(B) 2unit	11	11	11

## ■ PUMY-SP Series

Branch Box Connection Compatibility Table for PUMY-SP112/125/140

Series	Type	Model Name	Capacity										
			15	18	20	22	25	35	42	50	60	71	100
M series	Wall-Mounted	MSZ-LN•VG2					●	●		●			
		MSZ-RW•VG-E					●	●		●			
		MSZ-AP•VG(K)	●		●		●	●	●	●			
		MSZ-AY•VG(K)(P)	●		●		●	●	●	●			
		MSZ-FH•VE2					●	●	●	●			
		MSZ-EF•VG(K)		●		●	●	●	●	●			
		MSZ-SF•VA	●		●								
		MSZ-AP•VF-E	●		●								
	MSZ-SF•VE3					●	●	●	●				
	MSZ-GF•VE2									●	●		
	Floor-Standing	MFZ-KT•VG					●	●		●			
		MFZ-KJ•VE-E					●	●		●			
1-way Cassette	MLZ-KP•VF					●	●		●				
	MLZ-KA•VA-E					●	●		●				
S series	Ceiling-Concealed	SEZ-M•DA(L)(2)					●*1	●*1		●*1	●*1	●*1	
		SEZ-KD•VA-E					●*1	●*1		●*1	●*1	●*1	
	2x2 Cassette	SLZ-M•FA(2)	●*1				●*1	●*1		●*1			
		SLZ-KF•VA-E					●*1	●*1		●*1			
P series	Ceiling-Suspended	PCA-M•KA(2)						●*1		●*1	●*1	●*1	●*1
		PCA-RP•KAQ-E						●*1		●*1	●*1	●*1	●*1
	4-way Cassette	PLA-M•EA(2)						●*1		●*1	●*1	●*1	●*1
		PLA-RP•EA-E						●*1		●*1	●*1	●*1	●*1
	Ceiling-Concealed	PEAD-M•JA(L)(2)								●*1	●*1	●*1	●*1
		PEAD-RP•JAQ(L)-E								●*1	●*1	●*1	●*1

\*1 Some functions that can be used by connecting to the P series outdoor unit cannot be used with the PUMY series.

LEV Kit Connection Compatibility Table for PUMY-SP112/125/140

Series	I/U Type	Model Name	Capacity										
			15	18	20	22	25	35	42	50	60	71	
M series	Wall-Mounted	MSZ-LN•VG2					●	●		●			
		MSZ-AP•VG(K)	●		●		●	●	●	●			
		MSZ-AY•VG(K)(P)	●		●		●	●	●	●			
		MSZ-FH•VE2					●	●	●	●			
		MSZ-EF•VG(K)		●		●	●	●	●	●			
		MSZ-SF•VA	●		●								
		MSZ-AP•VF-E	●		●								
		MSZ-SF•VE3					●	●	●	●			
Floor-Standing	MFZ-KT•VG					●	●		●				

CITY MULTI Indoor Unit Compatibility Table for PUMY-SP112/125/140

Series	Type	Model Name	Capacity													
			P10	P15	P20	P25	P32	P40	P50	P63	P71	P80	P100	P125	P140	P200
CITY MULTI series	1-way cassette	PMFY-P•VBM-E			●	●	●	●								
		PLFY-P•VLM-D-E			●	●	●	●	●	●		●	●	●		
		PLFY-M•VEM-E			●	●	●	●	●	●		●	●	●		
		PLFY-M•VEM6-E			●	●	●	●	●	●	●	●	●	●		
		PLFY-P•VBM-E					●	●	●	●	●	●	●	●		
		PLFY-P•VEM-E					●	●	●	●	●	●	●	●		
		PLFY-P•VCM-E		●	●	●	●	●					●	●	●	
		PLFY-P•VFM-E		●	●	●	●	●	●							
	Ceiling-concealed	PEFY-P•VMR-E-L/R			●	●	●	●								
		PEFY-P•VMS1(L)-E		●	●	●	●	●	●	●						
		PLFY-P•VMA(L)-E			●	●	●	●	●	●	●	●	●	●	●	
		PEFY-M•VMA(L)-A(1)			●	●	●	●	●	●	●	●	●	●	●	
		PEFY-P•VMH(S)-E						●	●	●	●	●	●	●	●	
		PEFY-P•VMH-E-F									●				●	
		PEFY-P•VMHS-E-F												●	●	
	Ceiling-suspended	PCFY-P•VKM-E	●					●		●			●	●		
		PKFY-P•VLM-E	●	●	●	●	●	●	●							
	Wall-mounted	PKFY-P•VBM-E		●	●	●										
		PKFY-P•VHM-E					●	●	●							
		PKFY-P•VKM-E								●			●			
PDFY-P•VM-E				●	●	●	●	●	●	●	●	●	●			
Floor-standing	PFFY-P•VKM-E2			●	●	●	●	●								
	PFFY-P•VLEM-E			●	●	●	●	●	●							
	PFFY-P•VLRM-E			●	●	●	●	●	●	●						
	PFFY-P•VLRMM-E			●	●	●	●	●	●	●						
	PFFY-P•VCM-E			●	●	●	●	●	●	●						
Lossnay *1															GUF-50/100RD(H4)	

\*1 Do not connect Lossnay remote controller(s). (PZ-61DR-E, PZ-60DR-E, PZ-52SF-E, PZ-43SMF-E)



**■ PUMY-P Series**

Branch Box Connection Compatibility Table for PUMY-P112/125/140/200

Series	Type	Model Name	Capacity											
			15	18	20	22	25	35	42	50	60	71	100	
M series	Wall-Mounted	MSZ-LN•VG2					●	●	●	●	●			
		MSZ-AP•VG(K)	●		●		●	●	●	●	●			
		MSZ-AY•VG(K)(P)	●		●		●	●	●	●	●			
		MSZ-FH•VE2					●	●	●	●	●			
		MSZ-EF•VE		●		●	●	●	●	●	●			
		MSZ-EF•VG(K)		●		●	●	●	●	●	●			
		MSZ-SF•VA	●		●									
		MSZ-AP•VF	●		●									
		MSZ-SF•VE3					●	●	●	●	●			
	MSZ-GF•VE2										●	●		
	Floor-Standing	MFZ-KT•VG					●	●	●	●	●			
		MFZ-KJ•VE-E					●	●	●	●	●			
MLZ-KP•VF						●	●	●	●	●				
1-way Cassette	MLZ-KA•VA-E					●	●	●	●	●				
						●	●	●	●	●				
S series	Ceiling-Concealed	SEZ-M•DA(L)					●	●	●	●	●	●		
		SEZ-KD•VA-E					●	●	●	●	●	●		
		SEZ-M•DA(L)2-E					●	●	●	●	●	●		
	2x2 Cassette	SLZ-M•FA(2)	●				●	●	●	●	●			
SLZ-KF•VA-E						●	●	●	●	●				
P series	Ceiling-Suspended	PCA-M•KA(2)					●	●	●	●	●	●	●	
		PCA-RP•KAQ-E					●	●	●	●	●	●	●	
	4-way Cassette	PLA-M•EA(2)					●	●	●	●	●	●	●	
		PLA-RP•EA-E					●	●	●	●	●	●	●	
	Ceiling-Concealed	PEAD-M•JA(L)					●	●	●	●	●	●	●	
		PEAD-RP•JA(L)Q-E					●	●	●	●	●	●	●	
	PEAD-M•DA(L)2					●	●	●	●	●	●	●		

LEV Kit Connection Compatibility Table for PUMY-P112/125/140/200

Series	I/U Type	Model Name	Capacity										
			15	18	20	22	25	35	42	50	60	71	
M series	Wall-Mounted	MSZ-LN•VG2					●	●	●	●	●		
		MSZ-AP•VG(K)	●		●		●	●	●	●	●		
		MSZ-AY•VG(K)(P)	●		●		●	●	●	●	●		
		MSZ-FH•VE2					●	●	●	●	●		
		MSZ-EF•VG(K)		●		●	●	●	●	●	●		
		MSZ-SF•VA	●		●								
	MSZ-SF•VE3					●	●	●	●	●			
Floor-Standing	MFZ-KT•VG					●	●	●	●	●			

CITY MULTI Indoor Unit Compatibility Table for PUMY-P112/125/140

Series	Type	Model Name	Capacity													
			P10	P15	P20	P25	P32	P40	P50	P63	P71	P80	P100	P125	P140	P200
CITY MULTI series	1-way cassette	PMFY-P•VBM-E			●	●	●	●								
		2-way cassette			●	●	●	●	●	●		●	●	●		
		4-way cassette			●	●	●	●	●	●	●	●	●	●		
	Ceiling-concealed	PLFY-M•VEM-E			●	●	●	●	●	●		●	●	●		
		PLFY-M•VEM6-E			●	●	●	●	●	●	●		●	●		
		PLFY-P•VFM-E		●	●	●	●	●	●	●						
		PEFY-P•VMR-E-L/R			●	●	●	●	●	●						
		PEFY-P•VMS1(L)-E		●	●	●	●	●	●	●						
		PEFY-M•VMA(L)-A(1)			●	●	●	●	●	●	●	●	●	●	●	
	Ceiling-suspended	PEFY-P•VMHS-E							●	●	●	●	●	●	●	
		PEFY-P•VMHS-E-F												●	●	
		PCFY-P•VKM-E							●	●			●	●		
	Wall-mounted	PKFY-P•VLM-E	●	●	●	●	●	●	●	●						
		PKFY-P•VKM-E								●			●			
	Floor-standing	PFFY-P•VKM-E2			●	●	●	●	●	●						
		PFFY-P•VLEM-E			●	●	●	●	●	●	●					
		PFFY-P•VLRM-E			●	●	●	●	●	●	●					
		PFFY-P•VLRMM-E			●	●	●	●	●	●	●					
		PFFY-P•VCM-E			●	●	●	●	●	●	●					
ATW	PWFY-P•VM-E1 *1											●				
Lossnay *2		GUF-50/100RD(H)4														

CITY MULTI Indoor Unit Compatibility Table for PUMY-P200

Series	Type	Model Name	Capacity														
			P10	P15	P20	P25	P32	P40	P50	P63	P71	P80	P100	P125	P140	P200	
CITY MULTI series	1-way cassette	PMFY-P•VBM-E			●	●	●	●									
		2-way cassette			●	●	●	●	●	●		●	●	●			
		4-way cassette			●	●	●	●	●	●	●	●	●	●			
	Ceiling-concealed	PLFY-M•VEM-E			●	●	●	●	●	●		●	●	●			
		PLFY-M•VEM6-E			●	●	●	●	●	●	●		●	●			
		PLFY-P•VFM-E		●	●	●	●	●	●	●							
		PEFY-P•VMR-E-L/R			●	●	●	●	●	●							
		PEFY-M•VMA(L)-A(1)			●	●	●	●	●	●	●	●	●	●	●		
		PEFY-P•VMHS-E							●	●	●	●	●	●	●	●	
	Ceiling-suspended	PEFY-P•VMHS-E-F													●	●	
		PCFY-P•VKM-E							●	●			●	●			
		PKFY-P•VLM-E	●	●	●	●	●	●	●	●							
	Wall-mounted	PKFY-P•VKM-E								●			●				
													●				
	Floor-standing	PFFY-P•VKM-E2			●	●	●	●	●	●							
		PFFY-P•VLEM-E			●	●	●	●	●	●	●						
		PFFY-P•VLRM-E			●	●	●	●	●	●	●						
		PFFY-P•VLRMM-E			●	●	●	●	●	●	●						
		PFFY-P•VCM-E			●	●	●	●	●	●	●						
Lossnay *2		GUF-50/100RD(H)4															

\*1 Note that connection is not allowed inside EU countries and UK. PWFY can not connect to PUMY-P200YKM3.

\*2 Do not connect Lossnay remote controller(s). (PZ-61DR-E, PZ-60DR-E, PZ-52SF-E, PZ-43SMF-E)

## ■ PUMY-P Series

Branch Box Connection Compatibility Table for PUMY-P250/300

Series	Type	Model Name	Capacity										
			15	18	20	22	25	35	42	50	60	71	100
M series	Wall-Mounted	MSZ-LN•VG2					●	●		●			
		MSZ-RW•VG-E					●	●		●			
		MSZ-AP•VG(K)	●		●		●	●	●	●			
		MSZ-AY•VG(K)(P)	●		●		●	●	●	●			
		MSZ-FH•VE2					●	●		●			
	MSZ-EF•VG(K)		●		●	●	●	●	●				
	Floor-Standing	MSZ-KT•VG					●	●		●			
S series	Ceiling Concealed	SEZ-M•DA(L)2					●	●		●	●	●	
	2×2 Cassette	SLZ-M•FA2	●				●	●		●			
P series	Ceiling Suspended	PCA-M•KA2						●		●	●	●	●
	4-way Cassette	PCA-M•EA2						●		●	●	●	●
	Ceiling Concealed	PEAD-M•JA(2)						●		●	●	●	●

LEV Kit Connection Compatibility Table for PUMY-P250/300

Series	I/U Type	Model Name	Capacity							
			15	18	20	22	25	35	42	50
M series	Wall-Mounted	MSZ-LN•VG2					●	●		●
		MSZ-AP•VG(K)	●		●		●	●	●	
		MSZ-AY•VG(K)(P)	●		●		●	●	●	●
		MSZ-FH•VE2					●	●		●
		MSZ-EF•VG(K)		●		●	●	●	●	
	Floor-Standing	MFZ-KT•VG					●	●		●

CITY MULTI Indoor Unit Compatibility Table for PUMY-P250/300

Series	Type	Model Name	Capacity														
			P10	P15	P20	P25	P32	P40	P50	P63	P71	P80	P100	P125	P140	P200	P250
CITY MULTI series	1-way cassette	PMFY-P•VBM-E			●	●	●	●									
		2-way cassette	PLFY-P•VLM-E			●	●	●	●	●		●	●				
	4-way cassette	PLFY-M•VEM-E			●	●	●	●	●		●	●	●				
		PLFY-M•VEM6-E			●	●	●	●	●		●	●	●				
		PLFY-P•VFM-E		●	●	●	●	●	●								
	Ceiling-concealed	PEFY-P•VMR-E-L/R			●	●	●	●									
		PEFY-P•VMS1(L)-E		●	●	●	●	●	●								
		PEFY-M•VMA(L)-A			●	●	●	●	●		●	●	●	●	●		
		PEFY-P•VMA(L)-A1			●	●	●	●	●		●	●	●	●	●	●	
		PEFY-P•VMHS-E							●	●	●	●	●	●	●	●	●
		PEFY-P•VMHS-E-F							●	●	●	●	●	●	●	●	●
	Ceiling-suspended	PCFY-P•VKM-E							●		●		●	●			●
	Wall-mounted	PKFY-P•VLM-E	●	●	●	●	●	●	●								
		PKFY-P•VKM-E									●			●			
	Floor-standing	PFFY-P•VKM-E2			●	●	●	●	●								
		PFFY-P•VLEM-E			●	●	●	●	●		●	●					
		PFFY-P•VCM-E			●	●	●	●	●		●	●					
Lossnay *1		GUF-50/100RD(H)4															

\*1 Do not connect Lossnay remote controller(s). (PZ-61DR-E, PZ-60DR-E, PZ-52SF-E, PZ-43SMF-E)

## ■ PUMY-SM Series

Branch Box Connection Compatibility Table for PUMY-SM112/125/140

Model Name	15	18	20	22	25	35	42	50	60	71	100	
M series	MSZ-RW•VG							●				
	MSZ-LN•VG2					●	●	●				
	MSZ-AP•VG(K)	●		●		●	●	●				
	MSZ-AY•VG(K)(P)	●		●		●	●	●				
	MSZ-EF•VG(K)		●	●	●	●	●	●				
	MSZ-BT•VG(K)					●	●					
	MLZ-KY•VG		●									
	MLZ-KP•VF					●	●		●			
S series	SEZ-M•DA(L)2					●	●	●	●	●		
	SLZ-M•FA2	●				●	●	●				
P series	PCA-M•KA2					●	●	●	●	●	●	
	PLA-M•EA2					●	●	●	●	●	●	
	PEAD-M•JA(L)2					●	●	●	●	●	●	

CITY MULTI Indoor Unit Compatibility Table for PUMY-SM112/125/140

Model Name	Sensor	10	15	20	25	32	40	50	63	71	80	100	125	140
CITY MULTI series	PLFY-M•VEM6-E			●	●	●	●	●	●	●	●	●	●	
	PEFY-M•VMA(L)-A1			●	●	●	●	●	●	●	●	●	●	●
	PLFY-MS•VEM-E	✓		●	●	●	●	●	●	●	●	●	●	
	PLFY-MS•VFM-E	✓		●	●	●	●	●	●					
	PCFY-MS•VKM-E	✓						●	●			●	●	
	PKFY-MS•VLM-E	✓	●	●	●	●	●	●	●					
	PKFY-MS•VKM-E	✓							●			●	●	
PEFY-MS•VMA(L)-A	✓			●	●	●	●	●	●	●	●	●	●	

# Outdoor Unit Functions

## Demand control

This function reduces the capacity of the outdoor/heat source unit by way of the external input to the outdoor unit. The capacity of the outdoor unit can be reduced in steps, with patterns ranging from 2 to 12 control steps depending on the system. The number of steps that can be set and the corresponding capacity are shown below.

- 2 steps (0-100%)
- 4 steps (0-50-75-100%)
- 8 steps (0-25-38-50-63-75-88-100%)
- 12 steps (0-17-25-34-42-50-59-67-75-84-92-100%)

### Possible usage

When power consumption is centrally-controlled within a building, the system can be made to operate in capacity-save mode by receiving external signals.

#### • System settings example

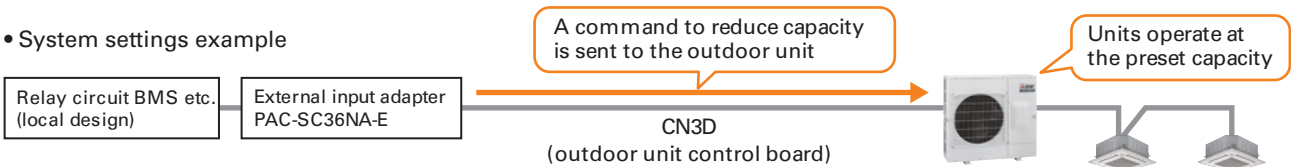

## Pump down function

This function collects the refrigerant that remains in the indoor unit and the outdoor/heat source unit piping when the refrigerant piping needs to be removed, such as when the air conditioner is relocated.

This function can also be used to stop the operation of the indoor unit and return the refrigerant to the outdoor/heat source unit in the event that a refrigerant leak is detected.

\* To detect a refrigerant leak, a circuit that includes a refrigerant leak detection sensor must be designed and prepared on site.

## Dual set point

Normally, the desired room temperature is set to the same value for cooling and heating. However, the dual set point function allows different temperatures to be set for cooling and heating. When operation switches from cooling to heating or vice versa, the preset temperature changes accordingly.

Setting dual set points in Auto mode on R2 models improves energy efficiency, compared to setting a single set point.

When the operation mode is set to Auto (dual set point) mode, two preset temperatures (one each for cooling and heating) can be set. Depending on the room temperature, the indoor unit will automatically operate in either the cooling or heating mode and keep the room temperature within the preset range.

The outdoor unit does not operate in the comfortable temperature band defined by two temperature points where the thermostat is off. This cuts down on unnecessary operation of the air conditioning system.

\* This function is supported only when all the indoor units, remote controllers, and system controllers that are connected to a given group are compatible with the function.

#### • Operation pattern in Auto (dual set point) mode

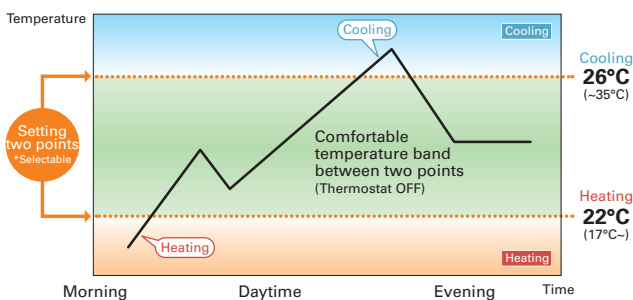

## Individual LEV control

Even if one of the indoor units stops for repair, the LEV of the indoor unit can be closed so that the other indoor units can continue to operate. (No preliminary setting is necessary.)

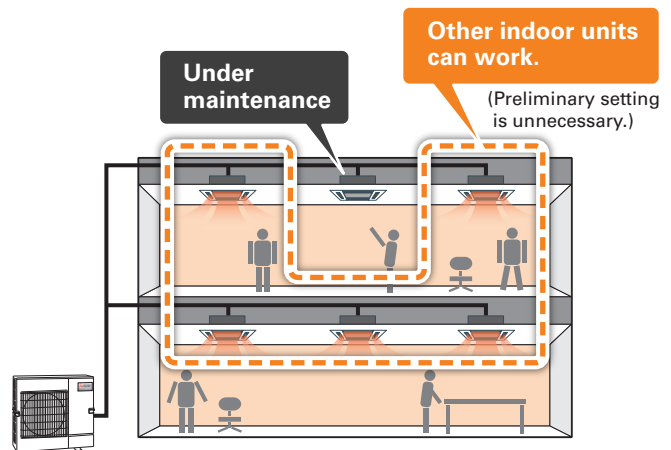

# NEW ECODESIGN DIRECTIVE

## WHAT IS THE ErP DIRECTIVE?

The Ecodesign Directive for Energy-related Products (ErP Directive) establishes a framework to set mandatory standards for ErPs sold in the European Union (EU). The ErP directive introduces new energy-efficiency ratings across various product categories and affects how products such as computers, vacuum cleaners, boilers and even windows are classified in terms of environmental performance.

Regulations that apply to air conditioning systems of rated capacity up to 12kW came into effect as of January 1, 2013. Based on the use of future-orientated technologies, Mitsubishi Electric is one step ahead of these changes, with our air conditioning systems already achieving compliance with these new regulations.

## NEW ENERGY LABEL AND MEASUREMENTS

Under regulation 2011/626/EU, supplementing directive 2010/30/EU, air conditioning systems are newly classified into energy-efficiency classes on the basis of a new energy labelling system, which includes three new classes: A+, A++ and A+++.

Revisions to the measurement points and calculations of the seasonal energy efficiency ratio (SEER) and seasonal coefficient of performance (SCOP) has resulted in changes to how air conditioning systems are classified into energy-efficiency classes.

Specifically, for cooling mode, air conditioning systems must achieve at least class B. For heating mode, air conditioning systems must achieve at least a SCOP value of 3.8.

### ■ New Energy Efficiency Label

**SEER and SCOP**  
The SEER (Seasonal Energy Efficiency Ratio) value indicates the seasonal energy efficiency ratio in the cooling mode. The SCOP (Seasonal Coefficient of Performance) value refers to the seasonal efficiency in the heating mode.

**Energy efficiency classes from A+++ to D SCOP in heating mode**

A+++	> 5,1
A++	> 4,6
A+	> 4,0
A	> 3,4
B	> 2,8
C	> 2,3
D	< 2,5

**Energy efficiency classes from A+++ to D SEER in cooling mode**

A+++	> 8,5
A++	> 6,1
A+	> 5,6
A	> 5,1
B	> 4,6
C	> 4,1
D	< 3,6

**Energy efficiency class**  
Energy efficiency class of the unit in cooling and heating mode of the unit model

**In the heating mode, the indication for the unit model is shown for all three climate zones.**

**Nominal capacity in cooling mode**  
SEER value  
Annual power consumption for cooling

**Operating noise, indoors/outdoors**  
The sound power level is an important sound energy parameter for assessing a sound source. Contrary to the sound pressure - the sound power is independent of the location of the source and/or the receiver. Maximally admissible values are:

Cooling capacity ≤ 6 kW		Cooling capacity > 6 kW ≤ 12 kW	
Indoor unit	Outdoor unit	Indoor unit	Outdoor unit
60dB(A)	65dB(A)	65dB(A)	70dB(A)

**Name or trademark of the manufacturer**  
**Name of the unit/designation of model**

**Time reference**  
Indication on label data

**Nominal capacity in heating mode**  
SCOP value  
Annual power consumption for heating

**Climate zones**  
For heating mode, the EU is divided into three climate zones for calculation and classification purposes. This aims at calculating the energy efficiency taking into consideration the actual regional ambient temperatures.

### ■ Climate Zones for Heating Mode

**Reference climate zones for calculating the SCOP**  
Since the climate conditions have a great influence on the operating behaviour in the heat pump mode, three climate zones have been stipulated for the EU: warm, moderate, cold. The measurement points are homogenous at 12°C, 7°C, 2°C and -7°C.

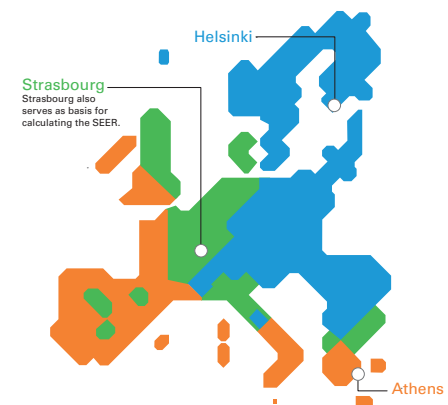

**Warm (Athens)**

Partial load	Temperature conditions		
	Outdoors	WB	Indoors
-	DB	WB	DB
100%	2°C	1°C	20°C
64%	7°C	6°C	20°C
29%	12°C	11°C	20°C

**Moderate (Strasbourg)**

Partial load	Temperature conditions		
	Outdoors	WB	Indoors
88%	-7°C	-8°C	20°C
54%	2°C	1°C	20°C
35%	7°C	6°C	20°C
15%	12°C	11°C	20°C

**Cold (Helsinki)**

Partial load	Temperature conditions		
	Outdoors	WB	Indoors
61%	-7°C	-8°C	20°C
37%	2°C	1°C	20°C
24%	7°C	6°C	20°C
11%	12°C	11°C	20°C

## SEER/SCOP

Air conditioning systems were previously assessed using the energy-efficiency rating (EER), which evaluated efficiency in cooling mode, and the coefficient of performance (COP), which defined the efficiency, or the ratio of consumed and output power, in heating mode. Under this system, assessments were not truly reflective of performance as they were based on a single measurement point, which led to manufacturers optimising products accordingly in order to achieve higher efficiency ratings. SEER and SCOP address this problem by including seasonal variation in the ratings via use of realistic measurement points. For cooling mode, measurements at outside temperatures of 20, 25, 30 and 35°C are incorporated and weighted in accordance with climate data for Strasbourg, which is used as a single reference point for the whole EU. For instance, for partial-load operation, which represents more than 90% of operation, there is a correspondingly high weighting for the efficiency classification. For heating mode, a comprehensive temperature profile for the whole EU was not possible, so the EU has been divided into three climate zones, north, central and south, and load profiles created. The same measurement points, at outside temperatures of 12, 7, 2 and -7°C, are used for all three zones.

### ■ SCOP Calculation

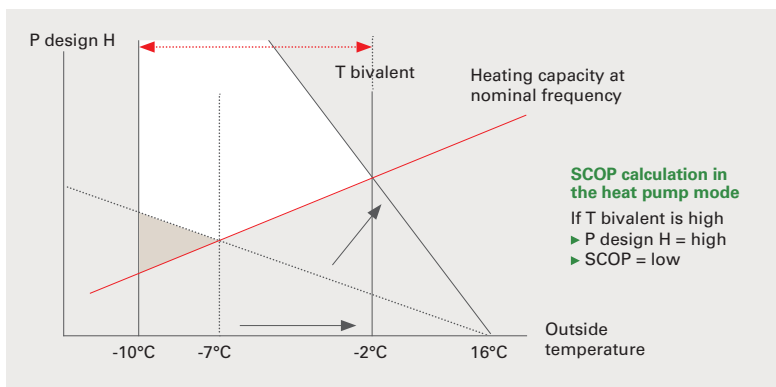

### Technical Terms with Respect to the SCOP

**P design H:** Corresponds to a heating load of 100%. The value depends on the selected bivalence point.

**T design:** Outside temperature which determines the P design H point. The latter is determined from the area conditions.

**T bivalent:** Corresponds to the lowest temperature at which full heating performance can be achieved with the heat pump (without additional heating). This point can be freely selected within the prescribed temperature ranges (T design - T bivalent).

## SOUND PRESSURE LEVEL

Consumers will also receive more information on the noise levels emitted by split-system air conditioners to help them make their purchasing decision. Specifically, the sound power level of indoor and outdoor units is to be indicated in decibels as an objective parameter. Knowing the sound power makes it possible to calculate sound emissions while considering distance and radiation characteristics, which is beneficial because it allows the noise levels of different air conditioning systems to be compared regardless of the usage location and how the sound pressure is measured. This is an improvement on sound pressure values which are usually measured at an approximate distance of 1 m where all modern split-system air conditioning systems tend to be very quiet at an average of 21 decibels.

### ■ Sound Pressure vs Sound Power Level

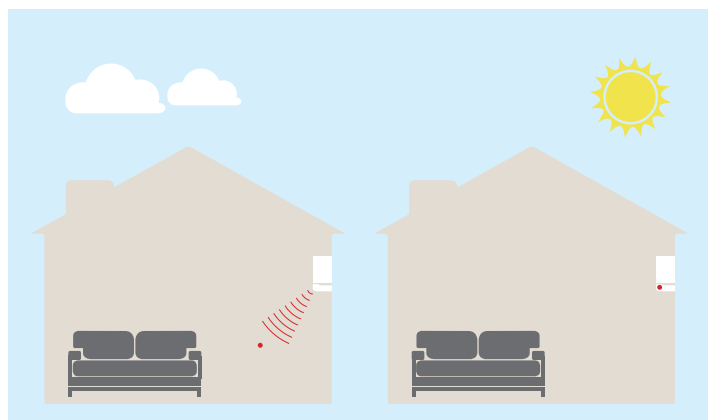

#### Sound pressure level dB(A)

The sound pressure level is a sound field parameter which indicates the perceived operating noise of an indoor unit within a certain distance.

#### Sound power level dB(A)

The sound power is an acoustic parameter which describes the source strength of a sound generator and is thus independent of the distance to the receiver location.

# COMFORT

## 3D i-see Sensor

### 3D i-see Sensor for M SERIES

The LN Series and FH Series are equipped with the 3D i-see Sensor, an infrared-ray sensor that measures the temperature at distant positions. While moving to the left and right, eight vertically arranged sensor elements analyze the room temperature in three dimensions. This detailed analysis makes it possible to judge where people are in the room, thus allowing creation of features such as "Indirect airflow," to avoid airflow hitting people directly, and "direct airflow" to deliver airflow to where people are.

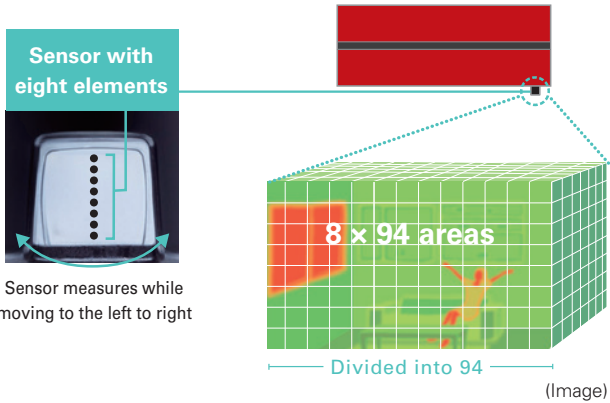

#### No occupancy energy-saving mode

The sensors detect whether there are people in the room. When no-one is in the room, the unit automatically switches to energy-saving mode.

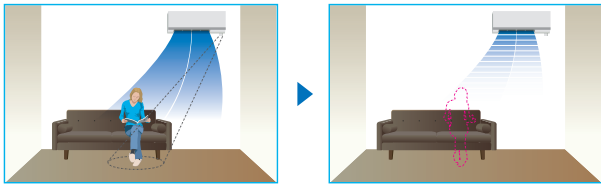

The "3D i-see Sensor" detects people's absence and the power consumption is automatically reduced approximately 10% after 10 minutes and 20% after 60 minutes.

#### Indirect Airflow

The indirect airflow setting can be used when the flow of air feels too strong or direct. For example, it can be used during cooling to avert airflow and prevent body temperature from becoming excessively cooled.



#### Direct Airflow

This setting can be used to directly target airflow at people such as for immediate comfort when coming indoors on a hot (cold) day.

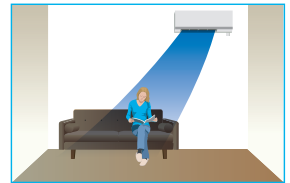

#### Even Airflow \*LN Series only

Normal swing mode

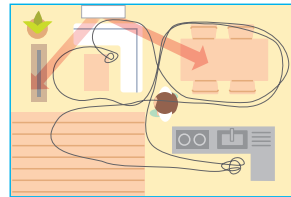

The airflow is distributed equally throughout the room, even to spaces where there is no human movement.

Even airflow mode

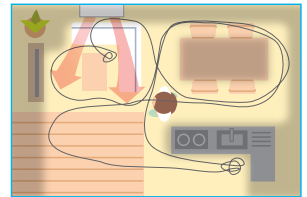

The 3D i-see sensor memorizes human movement and furniture positions, and efficiently distributes airflow.

#### No occupancy Auto-OFF mode \*LN Series only

The sensors detect whether or not there are people in the room. When there is no one in the room, the unit turns off automatically.

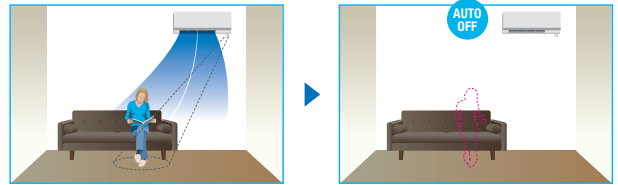

## ENERGY-SAVING



### Econo Cool Energy-Saving Feature

“Econo Cool” is an intelligent temperature control feature that adjusts the amount of air directed towards the body based on the air-outlet temperature. The setting temperature can be raised by as much as 2°C without any loss in comfort, thereby realising a 20% gain in energy efficiency. (Function only available during manual cooling operation.)

	Conventional	Econo Cool
<b>Ambient</b> temperature	35°C	35°C
<b>Set</b> temperature	25°C	27°C
<b>Perceived</b> temperature	30°C	29.3°C

#### Econo Cool Mode

A comfortable room environment is maintained even when setting the temperature 2°C higher than the conventional cooling mode.

Econo Cool on



Conventional cooling mode



Temperature distribution (°C)

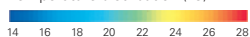

### Demand Function (Onsite Adjustment)

The demand function can be activated when the unit is equipped with a commercially available timer or an On/Off switch is added to the CNDM connector (option) on the control board of the outdoor unit. Energy consumption can be reduced up to 100% of the normal consumption according to the signal input from outside.

[Example: Power Inverter Series]

Limit energy consumption by changing the settings of SW7-1, SW2 and SW3 on the control board of the outdoor unit. The following settings are possible.

SW7-1	SW2	SW3	Energy consumption
ON	OFF	OFF	100%
	ON	OFF	75%
	ON	ON	50%
	OFF	ON	0% (Stop)

\*PUHZ outdoor only

## AIR DISTRIBUTION



### Double Vane

Double vane separates the airflow in the different directions to deliver airflow not only across a wide area of the room, but also simultaneously to two people in different locations.



### Horizontal Vane

The air outlet vane swings up and down so that the airflow is spread evenly throughout the room.



### Vertical Vane

The air outlet fin swings from side to side so that the airflow reaches every part of the room.



### High Ceiling Mode

In the case of rooms with high ceilings, the outlet-air volume can be increased to ensure that air is circulated all the way to the floor.



### Low Ceiling Mode

If the room has a low ceiling, the airflow volume can be reduced for less draft.



### Auto Fan Speed Mode

The airflow speed mode adjusts the fan speed of the indoor unit automatically according to the present room conditions.



### Circulator Mode

After reaching the target temperature, heating mode will automatically switch to circulator mode, which makes the unit go into “fan-only” state and mixes warm air to eliminate uneven temperature in the room.

# AIR QUALITY

## Plasma Quad Plus

Plasma Quad Plus is a plasma-based filter system that effectively removes six kinds of air pollutants. Plasma Quad Plus captures mold and allergens more effectively than Plasma Quad. It can also capture PM2.5 and particles smaller than 2.5µm, creating healthy living spaces for all.

### Bacteria

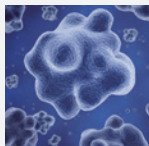

<LN series>  
Neutralizes 99% of Staphylococcus aureus in 162 minutes in a 25 m<sup>3</sup> test space.  
Test No.2016-0118 tested by KRCES-Bio.

<AY series 25-50>  
Neutralizes 99% of Staphylococcus aureus in 186 minutes in a 25 m<sup>3</sup> test space.  
Test No.22046475001-0301 tested by KRCES-Bio.

<AY series 15/20 >  
Neutralizes 99% of Staphylococcus aureus in 20 minutes.\*1  
Test No.2022\_1528 tested by KRCES-Bio.  
Neutralizes 93.9% in one pass conversion.

### Viruses

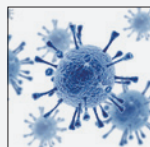

<LN series>  
Neutralized 99.8% of SARS-CoV-2 in 360 minutes.\*1  
Test No.20KB070569 tested by Japan Textile Products Quality and Technology Center  
Neutralizes 99% of Influenza A virus particles in 72minutes in a 25 m<sup>3</sup> test space.  
Test No.28-002 tested by vrc.center, SMC

<AY series 25-50>  
Neutralized 99.8% of SARS-CoV-2 in 360 minutes.\*1  
Test No.20KB070569 tested by Japan Textile Products Quality and Technology Center  
Neutralizes 99% of Influenza A virus particles in 210.5minutes in a 25 m<sup>3</sup> test space.  
Test No. R4-001 tested by National Hospital Organization Sendai Medical Center

<AY series 15/20 >  
Neutralizes 99% of Influenza A virus particles in 20 minutes.\*1  
Test No. 2022\_0528 tested by KRCES-Bio.  
Neutralizes 95.8% in one pass conversion.

### Molds

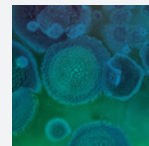

<LN series>  
Neutralizes 99% of Penicillium citrinum in 135 minutes in a 25 m<sup>3</sup> test space.  
Test No. 16069353001-0201 tested by Japan Food Research Laboratories

<AY series 25-50>  
Neutralizes 99% of Penicillium citrinum in 251 minutes in a 25 m<sup>3</sup> test space.  
Test No.22046475001-0401 tested by Japan Food Research Laboratories

<AY series 15/20 >  
Neutralizes 99% of Penicillium citrinum in 191 minutes in a 25 m<sup>3</sup> test space.  
Test No. LSRL-21010-G060 tested by Japan Food Research Laboratories

### Allergens

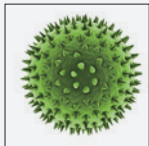

<LN series>  
Neutralizes 98% of cat fur and pollen.\*1  
Test No. T1606028 tested by ITEA Inc.

<AY series 25-50>  
Neutralizes 98% of cat fur and pollen.\*1  
Test No. T1606028 tested by ITEA Inc.

<AY series 15/20 >  
Neutralizes 91.8% of pollen.\*1  
Test No. T2301012 tested by ITEA Inc.

### PM2.5

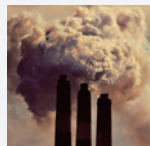

<LN series>  
Neutralizes 90% of PM2.5 particles in 83minutes, 99% of PM2.5 particles in 166minutes in a 28 m<sup>3</sup> test space.  
In-Company Investigation

<AY series 25-50>  
Neutralizes 90% of PM2.5 particles in 189 minutes, 99% of PM2.5 particles in 378 minutes in a 28 m<sup>3</sup> test space.  
Test No. LSRL 21010 F105 tested by Life Science Research Laboratory (Japan)

<AY series 15/20 >  
Neutralizes 90% of PM2.5 particles in one pass.  
Test No. LSRL\_21010\_G063 tested by Life Science Research Laboratory (Japan)

### Dust

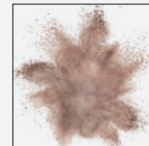

<LN series>  
Neutralizes 99.7% of dust and mites.\*1  
Test No.T1606028 tested by ITEA Inc.

<AY series 25-50>  
Neutralizes 99.7% of dust and mites.\*1  
Test No.T1606028 tested by ITEA Inc.

<AY series 15/20 >  
Neutralizes 97% of dust (JIS test POWDER 1 Class 11(JIS11)).\*1  
Test No.LSRL-21010\_G063 tested by ITEA Inc.

\*1 The test was conducted on the Plasma Quad Plus device alone, not designed to evaluate product performance.

### Image of Plasma Quad Plus



### Principle of Plasma Quad Plus

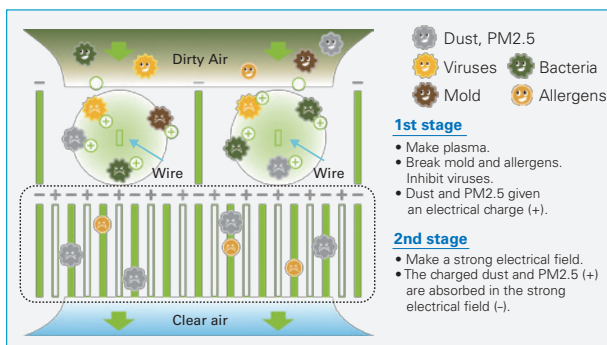









Hi-performance Plasma Filtration System

# Plasma Quad Connect (Optional Parts)





Plasma Quad Connect is an high-performance air purifying device which can even be installed on the existing units, contributing to a better air quality in your room. Plasma Quad Connect applies a voltage of 6,000 volts to the electrode to generate plasma, effectively removing various kinds of particles such as viruses, bacteria, molds, allergens, dust, and PM2.5.



 <b>Virus</b> 99% inhibited*1 *2	 <b>Bacteria</b> 99% inhibited*2
 <b>Mold</b> 99% inhibited*2	 <b>Dust</b> 99.7% inhibited
 <b>Allergen</b> 98% inhibited	 <b>PM2.5</b> 99% inhibited*2

\*1 The result of test with Influenza A virus.  
\*2 The result is based on the test with a device installed on the representative indoor unit. (MSZ-AP series)

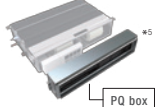
## Specifications

Model Name	MAC-100FT-E	PAC-HA11PAR, PAC-HA31PAR PAC-HA21PAU, PAC-HA31PAU (Attachment for Ducted Indoor Units)*1, *3	PAC-KE91PTB-E, PAC-KE92PTB-E PAC-KE93PTB-E, PAC-KE94PTB-E PAC-KE95PTB-E (Box for Ducted Indoor Units)*1, *3	PAC-SK51FT-E <sup>14</sup>	SLP-2FAP, SLP-2FALP SLP-2FALMP2
Product Image		 *5	 *5		 *5
Compatible with	MSZ, PKA, and PKFY *2 (Wall mounted models)	SEZ, PEAD, and PEFY *2	PEAD, and PEFY *2	PLA and PLFY *2 (4-way Cassette 3x3 models)	SLZ, and PLFY *2 (2x2 Cassette)
Input Voltage	Single Phase AC220~240V	—	—	Single Phase AC220~240V	Single Phase AC220~240V
Frequency	50/60Hz	—	—	50/60Hz	50/60Hz
Power Consumption	4W	—	—	4W	4W
Size H×W×D	56mm × 499.5mm × 168mm	—*6	247mm × 917mm × 179mm*7	134mm × 840mm × 840mm	20mm × 625mm × 625mm
Weight	1,600g	360g *6	4,570g *7	8,700g	4,400g

\*1 Both MAC-100FT-E and PQ Attachment or PQ box will be required when using with ducted models. \*2 Please contact your nearest sales office about compatible model. \*3 Specifications are subject to change without notice.  
\*4 When multi-functional casement or automatic filter elevation panel is used/installed, PAC-SK51FT-E can not be used. \*5 The image shows rear suction. \*6 Depends on model. Shows weight of PAC-HA11PAR.  
\*7 Depends on model. Shows size/weight of PAC-KE92PTB-E. \*8 Plasma Quad Connect cannot be used with PAC-SK54/46KFE (V blocking filter).

## Test Report Results

Following test results were conducted under controlled laboratory conditions. Performance might differ in real life environment.

Tested Materials	Tested Standard	Capacity	Time	Result	Testing Organization	Test Report	
Virus	New Coronavirus (SARS-CoV-2)	Original	—*8	360min	99.8% inhibited*9	Japan Textile Products Quality and Technology Center	20KB070569
	Influenza A	JEM1467	25m <sup>3</sup>	175min	99% inhibited*10	SMC Virus Research Center Japan (JAPAN)	R2-003
Bacteria	Staphylococcus Aureus	GB21551.6-2010	30m <sup>3</sup>	335min	99% inhibited*10	CHEARI (Beijing) Certification & Testing Co., Ltd.	WK-21-50161
Mold	Penicillium Citrinum	JEM1467	25m <sup>3</sup>	160min	99% inhibited*10	Life Science Research Laboratory (JAPAN)	LSRL-51021E-E091
Allergen	Cat Fur and Pollen	Original	—*8	—	98% inhibited*11	Institute of Tokyo Environmental Allergy (JAPAN)	No.T1606028
Dust	Dust and Mites	Original	—*8	—	99.7% inhibited*11	Institute of Tokyo Environmental Allergy (JAPAN)	No.T1606028
PM2.5	Cigarette smoke	JEM1467	25m <sup>3</sup>	300min	99% inhibited*10	Life Science Research Laboratory (JAPAN)	SRL-21010E-E091

\*8 The test was conducted on the Plasma Quad device alone, not designed to evaluate product performance. \*9 The result without the effect of natural attenuation is 96.3%.  
\*10 The result is based on the test with a device installed on the representative indoor unit. (MSZ-AP series) \*11 It shows the result when allergen and dust pass through the device once.

# AIR QUALITY

## Self Clean mode

When Self Clean Mode is activated, fan operation starts after cooling/dry mode. This operation helps to dry inside indoor unit to prevent molds and odors. You can feel the clean air without frequent cleaning by yourself.

① High humidity inside the unit, which can lead to mold growth and odors.

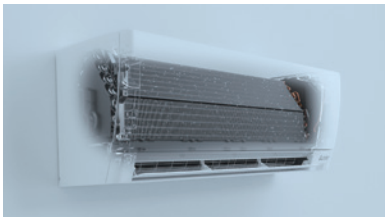

② Airflow operation suppresses mycelial growth.

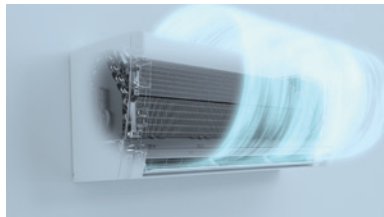

③ Maintains clean unit interior.



## Filters & Cleaning Functions

### Fresh-air Intake

Indoor air quality is enhanced by the direct intake of fresh exterior air.

### High-efficiency Filter

This high-performance filter has a much finer mesh compared to standard filters, and is capable of capturing minute particulates floating in the air that were not previously caught.

### Air Purifying Filter

The filter has a large capture area and also generates antibacterial, antifungal, and deodorant effects.

### Oil Mist Filter

The oil mist filter prevents oil mist from penetrating into the inner part of the air conditioner.

### Long-life Filter

A special process for the entrapment surface improves the filtering effect, making the maintenance cycle longer than that of units equipped with conventional filters.

### Filter Check Signal

Air conditioner operating time is monitored, and the user is notified when filter maintenance is necessary.

### Silver-ionized Air Purifier Filter

Silver-ionized Air Purifier Filter made of non-woven fabric can capture tiny particles. Silver ions and enzymes contained in the filter effectively act on bacteria and allergens and neutralises them.

### Dual Barrier Coating

A two-barrier coating which prevents hydrophobic and hydrophilic dirt from sticking to the inner surface and inner parts of the indoor unit.

### Dual Barrier Material

Antifouling materials are kneaded into horizontal vane and vertical vane, preventing dust and greasy dirt accumulating on the surface of indoor unit.

### Deodorising Filter

The catalyst in the Deodorising Filter denatures the odorous components and destroys them from the source of the odour, quickly delivering fresh air to your room.

### V Blocking Filter

V Blocking Filter with antiviral effect inhibits 99% of adhered virus, and other harmful substances, such as bacteria, mold and allergen. Two-layered filter with non-woven fabric and electrostatic filter can effectively capture and remove small particles from the air in your room.



# CONVENIENCE

## CONVENIENCE

### "i save" Mode

"i save" is a simplified setting function that recalls the preferred (preset) temperature by pressing a single button on the remote controller. Press the same button twice in repetition to immediately return to the previous temperature setting.

Using this function contributes to comfortable waste-free operation, realising the most suitable air conditioning settings and saving on power consumption when, for example, leaving the room or going to bed.

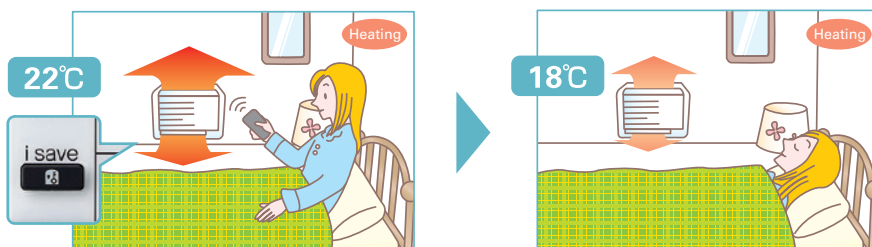

\* Temperature can be preset to 10°C when heating in the "i-save" mode.

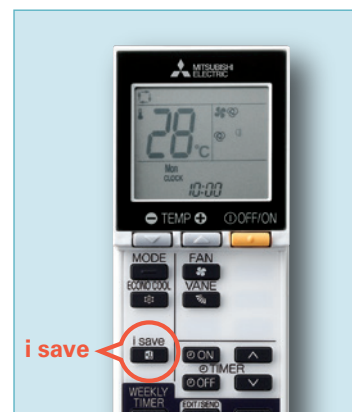

### Auto Changeover

The air conditioner automatically switches between heating and cooling modes to maintain the desired temperature.

### Low-temperature Cooling

Intelligent fan speed control in the outdoor unit ensures optimum performance even when the outside temperature is low.

### Ampere Limit Adjustment

Dip switch settings can be used to adjust the maximum electrical current for operation. This function is highly recommended for managing energy costs.

\* Maximum capacity is lowered with the use of this function.

### Operation Lock (Indoor unit)

To accommodate specific-use applications, cooling or heating operation can be specified using the wireless remote controller. A convenient option when a system needs to be configured for exclusive cooling or heating service.

### Operation Lock (Outdoor unit)

To accommodate specific-use applications, cooling or heating operation can be specified when setting the control board of the outdoor unit. A convenient option when a system needs to be configured for exclusive cooling or heating service.

### Auto Restart

Especially useful at the time of power outages, the unit turns back on automatically when power is restored.

### 10°C Heating

During heating operation, the temperature can be set in 1°C increments down to 10°C.

\* MLZ and MFZ series: Only when using "i-save" mode, the temperature can be set to 10°C, but not in 1°C increments.

#### DIP Switch Setting (Board for MXZ-5E102)

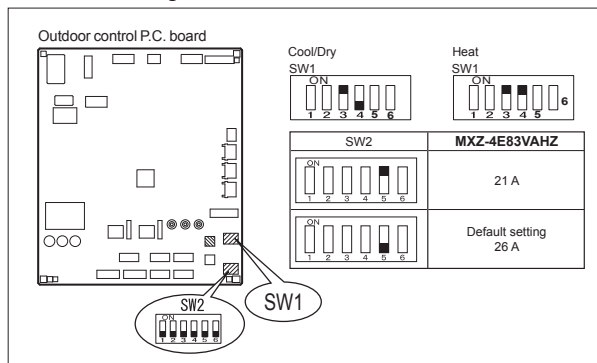

## Night Mode

When Night Mode is activated using the wireless remote controller, it will switch to the settings described below.

- The brightness of the operation indicator lamp will become dimmer.
- The beeping sound will be disabled.
- The outdoor operating noise will drop to 3dB lower than the rated specification operating noise.

\*The cooling/heating capacity may drop.

\*Night mode does not function when connected to MXZ.

## Low-noise Operation (Outdoor Unit)

System operation can be adjusted to prioritise less noise from the outdoor unit over air conditioning performance.

## On/Off Operation Timer

Use the remote controller to set the times of turning the air conditioner On/Off.

## Weekly Timer Function

Easily set desired temperatures and operation ON/OFF times to match lifestyle patterns. Reduce wasted energy consumption by using the timer to prevent forgetting to turn off the unit and eliminate temperature setting adjustments.

### Example Operation Pattern (Winter/Heating mode)

	Mon.	Tues.	Wed.	Thurs.	Fri.	Sat.	Sun.
6:00	ON 20°C	ON 20°C	ON 20°C	ON 20°C	ON 20°C	ON 20°C	ON 20°C
8:00	Automatically changes to high-power operation at wake-up time						
10:00	OFF	OFF	OFF	OFF	OFF	ON 18°C	ON 18°C
12:00	Automatically turned off during work hours					Midday is warmer, so the temperature is set lower	
14:00							
16:00							
18:00	ON 22°C	ON 22°C	ON 22°C	ON 22°C	ON 22°C	ON 22°C	ON 22°C
20:00	Automatically turns on, synchronized with arrival at home					Automatically raises temperature setting to match time when outside-air temperature is low	
22:00							
(during sleeping hours)	ON 18°C	ON 18°C	ON 18°C	ON 18°C	ON 18°C	ON 18°C	ON 18°C
	Automatically lowers temperature at bedtime for energy-saving operation at night						

### Settings

**Pattern Settings:** Input up to four settings for each day

**Settings:** • Start/Stop operation • Temperature setting • The operation mode cannot be set.

## Easy set-up using dedicated buttons



The remote controller is equipped with buttons that are used exclusively for setting the Weekly Timer. Setting operation patterns is easy and quick.

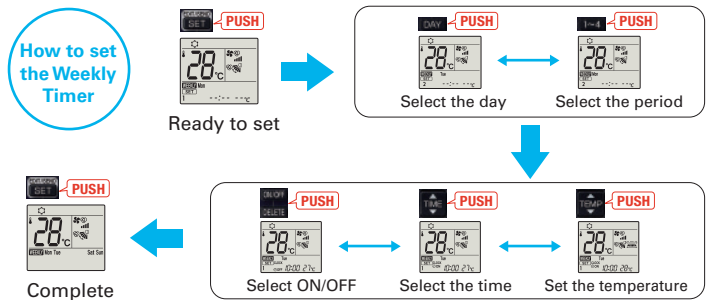

- Start by pushing the "SET" button and follow the instructions to set the desired patterns. Once all of the desired patterns are input, point the top end of the remote controller at the indoor unit and push the "SET" button one more time. (Push the "SET" button only after inputting all of the desired patterns into the remote controller memory. Pushing the "CANCEL" button will end the set-up process without sending the operation patterns to the indoor unit).
- It takes a few seconds to transmit the Weekly Timer operation patterns to the indoor unit. Please continue to point the remote controller at the indoor unit until all data has been sent.

## Back Light Remote Controller

Not only the indoor units, but the wireless remote controllers come in four colours as well. Each remote controller matches the indoor unit. Even the textures are the same.

The setting can be easily checked in the dark.



# INSTALLATION & MAINTENANCE

## INSTALLATION



### Cleaning-free Pipe Reuse

It is possible to reuse the same piping. It allows cleaning-free renewal of air conditioning systems that use R22 or R410 refrigerant.



### Reuse of Existing Wiring

Wiring recycling problem solved! Compatible with other wiring connection methods\*

The wiring method has been improved, making it possible to use methods different from that utilized for control and power supply. Units are compatible with the dual harness control line/power line method and the separate power supply method. Using a power supply terminal kit, wire can be efficiently reused at the time of system renewal regardless of the method the existing system uses.

\* Optional. Usage may be limited due to wiring type diameter.

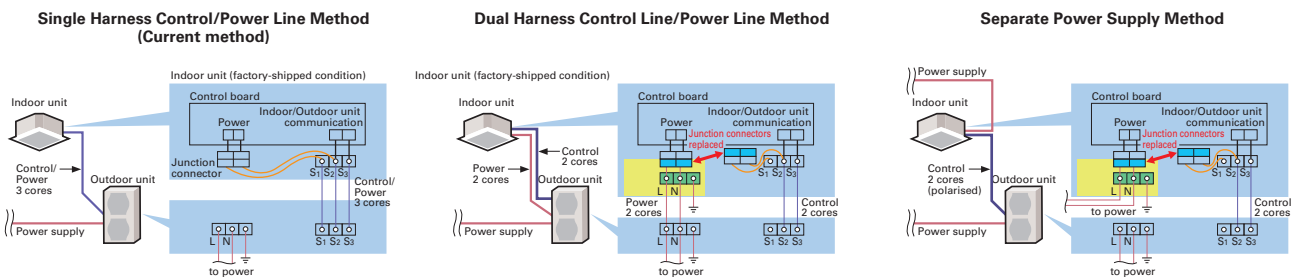

### Wiring/Piping Correction Function\*

The push of a single button is all that is required to confirm that piping and wiring are properly connected. Corrections are made automatically if a wiring error is detected, eliminating the need for complicated wiring confirmation work when expanding the number of rooms served.

\* This function cannot be used when the outdoor temperature is below 0°C. The correction process requires 10–20 minutes, and only works when the unit is set to the Cooling mode.

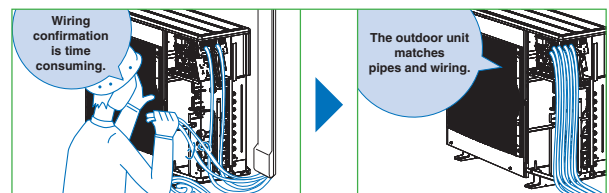

### Drain Pump

A built-in drain pump enables drain piping to be raised.

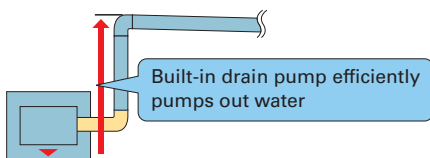

### Flare Connection

Flare connection to cooling pipe work is possible.



### Pump Down Switch

Enables smooth and easy recovery of refrigerant. Simply press the "Pump Down" switch before moving or changing the unit.

Outdoor unit control circuit board



\* Photo of Model PUHZ-P100

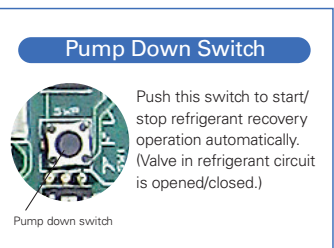

## MAINTENANCE



### Self-Diagnostic Function (Check Code Display)

---

Check codes are displayed on the remote controller or the operation indicator to inform the user of malfunctions detected.



### Failure Recall Function

---

Operation failures are recorded, allowing confirmation when needed.

# SYSTEM CONTROL

## SYSTEM CONTROL

### PAR-41MAA/PAC-YT52CRA/PAC-CT01MAA

Units are compatible for use with the PAR-41MAA, PAC-YT52CRA or PAC-CT01MAA remote controller, which has a variety of management functions.

### System Group Control

The same remote controller is capable of controlling the operational status of up to 16 refrigerant systems.

### M-NET Connection

Units can be connected to MELANS system controllers (M-NET controllers) such as the AG-150A.

### MELCloud (Wi-Fi interface)

#### MELCloud for fast, easy remote control and monitoring

MELCloud is a Cloud-based solution for controlling air-conditioner either locally or remotely by computer, tablet or smartphone via the Internet. Setting up and remotely operating via MELCloud is simple and straight forward. All you need is wireless computer connectivity in your home or the building where the air-conditioner is installed and an Internet connection on your mobile or fixed terminal. To set up the system, the router and the Wi-Fi interface must be paired, and this is done simply and quickly using the WPS button found on all mainstream routers. You can control and check air-conditioner via MELCloud from virtually anywhere an Internet connection is available. That means, thanks to MELCloud, you can use much more easily and conveniently.

#### Key control and monitoring features

- 1 Turn system on/off
- 2 See status of operating & adjust set point
- 3 Live weather feed from your location
  - Schedule timer - Set 7 day weekly schedule
  - Error status
- 4 Energy Consumption Monitoring



MELCloud uses the MAC-587IF interface



### When mounting on the wall

The interface can be mounted simply by affixing the holder to the wall on either side of the unit and inserting the interface unit into the holder.



\*When mounting on the right side of the unit

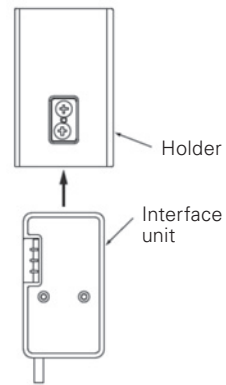

### When mounting on the outer side of the unit

The interface can be mounted on the right side, left side, bottom right, or bottom left of the indoor unit. After inserting the clip into the holder, slip the clip over the edge of the corner box.

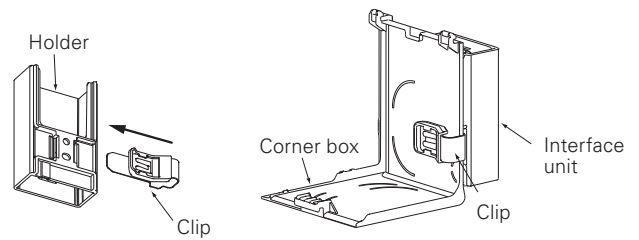

Right side



Bottom right



Left side



Bottom left

# CONTROL TECHNOLOGIES

## Extended cooling set temperature range\*

In environments such as gyms where people do strenuous exercise, even if the room is cooled to an appropriate temperature, people may feel that it is hot, and they need a cooler air. To satisfy such demands, we have extended the lower limit of the cooling set temperature range from 19–30°C. to 14–30°C.

\*Insulation kit (PAC-SK36HK-E) is required when indoor unit is PLA series.

\*Availability of this function is depending on outdoor unit, indoor unit and remote controller.

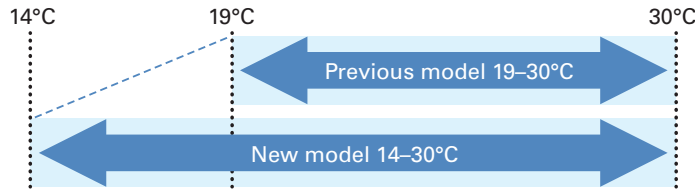

## Display of model names and serial numbers\*

The model names and serial numbers of the indoor/outdoor units that are connected to the MA smart remote controller can be automatically acquired and displayed through one simple operation. This eliminates the need to directly check each unit and helps with inquiries in the case of an abnormality.

\*Availability of this function is depending on outdoor unit, indoor unit and remote controller.

●Model name display (example)

Collect model names and S/N	
OU	PUZ-ZM200YKA2
IU1	PLA-ZM50EA2
IU2	PLA-ZM50EA2
IU3	PLA-ZM50EA2
IU4	PLA-ZM50EA2

Collect data: ✓  
-Address + S/N

●Serial number display (example)

Collect model names and S/N	
OU	1ZU00001
IU1	1ZA00001
IU2	1ZA00002
IU3	1ZA00003
IU4	1ZA00004

Collect data: ✓  
-Address + Model

## Preliminary error history\*

In addition to error history, the history of permissible abnormalities can be displayed. The feature enables the unit status check during inspection and maintenance.

\*Availability of this function is depending on outdoor unit, indoor unit and remote controller.

### ●Error history (Sample)

Error history			1/4
Error	Unt#	dd/mm/yy	
E0	0-1	21/10/20 PM12:34	
E0	0-1	20/12/20 AM 1:23	
E0	0-1	20/11/20 PM10:55	
E0	0-1	20/10/20 PM12:01	

Error history menu: ⌂  
- Page + Delete

### ●Preliminary error history (Sample)

Preliminary error hist.			1/8
Error	Unt#	dd/mm/yy	
E0	0-1	21/10/20 PM12:34	
E0	0-1	20/12/20 AM 1:23	
E0	0-1	20/11/20 PM10:55	
E0	0-1	20/10/20 PM12:01	

Error history menu: ⌂  
- Page + Delete

## Display of power consumption\*

It is possible to measure, acquire, and display the amount of energy used by each air conditioning system.

\*Availability of this function is depending on outdoor unit, indoor unit and remote controller.

< Data Collection Period >

Time data: Every 30 minutes over the past month

Monthly/daily data: Monthly over the past 14 months

Energy consumption values are calculated from estimated power consumption values according to the operating conditions. They may vary from the actual power consumption values. Please note that the power consumption of optional parts is not included except in the case of optional parts that have their power supplied directly by the outdoor unit.

### ●Every 30 minutes (example)

Energy data			
2019-1-1	1234.5kWh	1/6	
0:30	123.4kWh	2:30	123.4kWh
1:00	123.4kWh	3:00	123.4kWh
1:30	123.4kWh	3:30	123.4kWh
2:00	123.4kWh	4:00	123.4kWh

Return: ⌂  
- Date + Page

### ●Daily (example)

Energy data			
2019-1	123456.7kWh	1/4	
31	1234.5kWh	27	1234.5kWh
30	1234.5kWh	26	1234.5kWh
29	1234.5kWh	25	1234.5kWh
28	1234.5kWh	24	1234.5kWh

Return: ⌂  
- Page +

### ●Monthly (example)

Energy data			
▶2019-1	123456.7kWh	1/3	
2018-12	123456.7kWh		
2018-11	123456.7kWh		
2018-10	123456.7kWh		
2018-9	123456.7kWh		

View daily data: ✓  
- Cursor +

## Horizontal airflow settings

The 4-way cassette model with 3D Total Flow system lets you easily set the horizontal air-flow direction. This allows you to freely tailor the air conditioning performance according to your particular space and purpose.

\*PLP-160ELR-E is required to activate this function.

### When 3D Total Flow is equipped

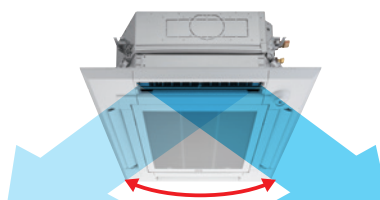

The horizontal airflow direction can be fixed for each outlet

Airflow direction set (Horiz)

4	2	3
---	---	---

Select: ✓  
- Outlet + Angle

Default	Left
Centre-left	Front
Centre-right	Right

## Wi-Fi interface setting

When setting up a wireless LAN connection, it is now possible to switch between WPS and AP modes via the remote controller. You can configure a wireless network using the most convenient method according to the installation environment.

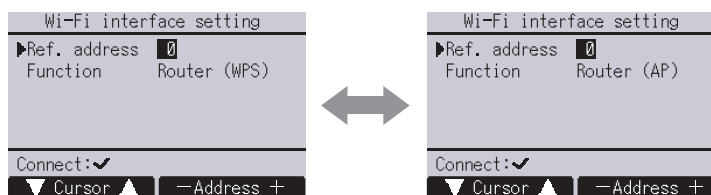

## Easy To Read & Easy To Use

### Inverted display screen

The screen background color can be set to black to suit the atmosphere of the installation location.



## Full Dot Liquid-crystal Display Adopted

Easier to read thanks to use of a full dot liquid-crystal display with backlight, and easier to use owing to adopting a menu format that has reduced the number of operating buttons.

### Display Example [Operation Mode]

Full Dot LCD



## Multi-language Display

### Multi-language

### Control panel operation in fourteen different languages

Choose the desired language, among the following languages.



## Temperature Control

### Dual Set Point

### Two preset temperatures

When the operation mode is set to the Auto (Dual Set Point) mode, two preset temperatures (one each for cooling and heating) can be set. Depending on the room temperature, indoor unit will automatically operate in either the COOL or HEAT mode and keep the room temperature within the preset range.

Automatically operate in either the COOL or HEAT mode and keep the room temperature within the preset range.



### Operation pattern during Auto (Dual Set Point) mode

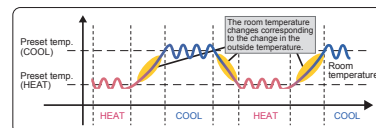

\*Please refer to the function list on page 205-211 for the combination of the available units.

## Energy-efficient Control

### Operation Control Functions

### Energy-saving Schedule

### Precise control of power consumption

The amount of power consumed in each time period is managed so that the demand value is not exceeded. The demand control function can be set to start and finish in 5-minute units.

Additionally, the level can be adjusted to 0, 50, 60, 70, 80 or 90% of maximum capacity, and up to 4 patterns can be set per day. Air-conditioning operation is automatically controlled to ensure that electricity in excess of the contracted volume is not consumed.

### Setting pattern example

Start time	Finish time	Capacity savings
8:15	→ 12:00	80%
12:00	→ 13:00	50%
13:00	→ 17:00	90%
17:00	→ 21:00	50%

### Auto-return

Prevents wasteful operation by automatically returning to the preset temperature after specified operating time

After adjusting the temperature for initial heating in winter or cooling on a hot summer day, it is easy to forget to return the temperature setting to its original value. The Auto-return function automatically resets the temperature back to the original setting after a specified period of time, thereby preventing overheating/overcooling. The Auto-return activation time can be set in 10-minute units, in a range between 30 and 120 minutes.

\*Auto-return cannot be used when Temperature Range Restrictions is in use.

### Auto-off Timer

Turns heating/cooling off automatically after preset time elapses

When using Auto-off Timer, even if one forgets to turn off the unit, operation stops automatically after the preset time elapses, thereby preventing wasteful operation. Auto-off Timer can be set in 10-minute units, in a range between 30 minutes and 4 hours. Eliminates all anxiety about forgetting to turn off the unit.

Recommended for **Meeting room** **Changing room**

# CONTROL TECHNOLOGIES

**MA Touch Remote Controller**  
**PAR-CT01MAA-SB**  
**PAR-CT01MAA-PB**



PAC-CT01MAA-SB



PAR-CT01MAA-PB

## User-friendly Visible big size icons on the full color touch panel display

### Full color touch panel display



Touch Panel

3.5 inch/HVGA Full Color LCD



### Operation panels



Temperature setting



Operation mode



Fan speed



Vane control



Ventilation



Louver control

## Flexibility Customized display, color on parameter and background, editable parameter, logo image on the initial display

### Multiple color pattern

180 color patterns can be selected for control parameters or background on the display.

### Control parameter customize

Users can customize the panel to display the selected parameters only.

#### ● Control parameter customize

Simple operation panel is preferred by users, especially in hotels. It is available to display only ON/OFF, set temp., fan speed.



### Logo image customization

Logo image can be displayed on the initial screen.



160 pixels

320 pixels

Available in a wide variety of colors to suit the decor of any room.



## Expandability Smartphone / tablet App is available for setting, customize, and control.

### Bluetooth® low energy technology

Remote controller can communicate with smartphone or tablet device via Bluetooth Low Energy (BLE). Operation & Setting App are available on the App store.



\*The Bluetooth® word mark is trademark of Bluetooth SIG, Inc., USA.  
\*Contact the sales company for information on "Bluetooth" function.

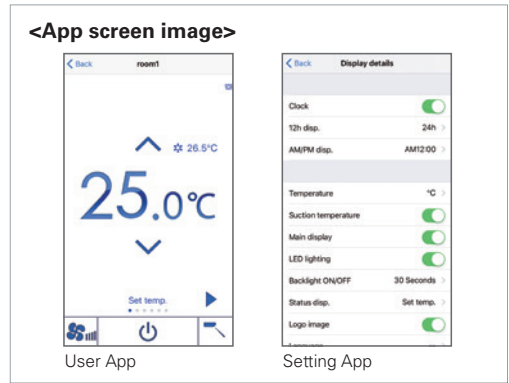

### Convenient BLE transmission functions for installation contractors

Initial setup for the remote controller can be easily performed using BLE transmission via a smartphone.

#### ● Previous model

Previously, initial setup (selecting function parameters) was only available via the remote controller installed each room.

#### ● New model

The initial setup (selecting function parameters) can now be performed in advance on a smartphone, with the settings transmitted to the remote controller by enabling BLE transmission upon entry to the room.

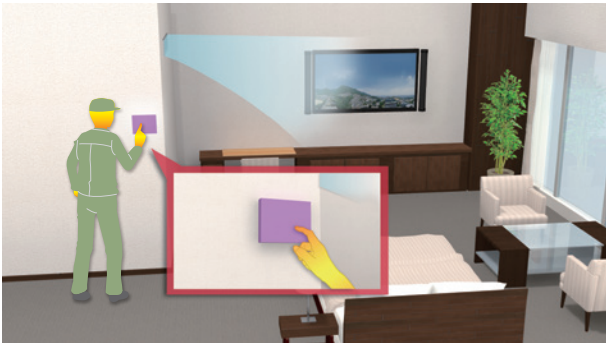

### Convenient BLE transmission functions for guests

The remote controller has been further upgraded with hotels in mind, to allow smartphone connectivity and multilingual support.

#### Smartphone connectivity

For example, hotel guests can operate the air conditioner via their smartphones, without getting out of bed.



#### Multilingual support

The smartphone app can be displayed in the language that the guest's smartphone is set to.



# CONTROL TECHNOLOGIES

## Wireless Remote Controller PAR-SL101A-E

### Extended cooling set temperature range\*

In environments such as gyms where people do strenuous exercise, even if the room is cooled to an appropriate temperature, people may feel that it is hot, and they need a cooler air. To satisfy such demands, we have extended the lower limit of the cooling set temperature range from 19–30°C. to 14–30°C.



\*Insulation kit (PAC-SK36HK-E) is required when indoor unit is PLA series.  
\*Availability of this function is depending on outdoor unit, indoor unit and remote controller.

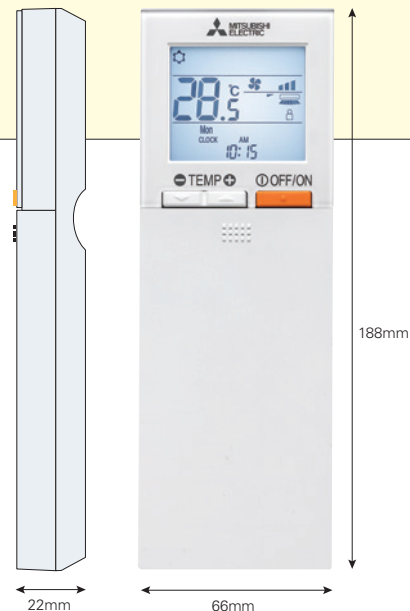
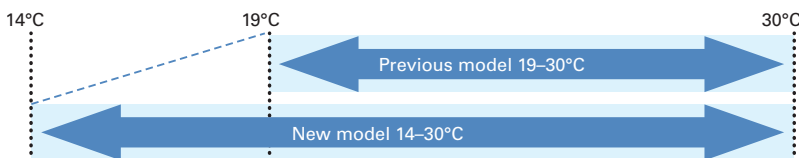

### Horizontal airflow settings

The 4-way cassette model complete with the Smart 360-degree Airflow system lets you easily set the horizontal airflow direction. This allows you to freely tailor the air conditioning performance according to your particular space and purpose.

Front	Centre-right	Right	Centre-left	Left	No setting

#### [Setting the horizontal airflow function]

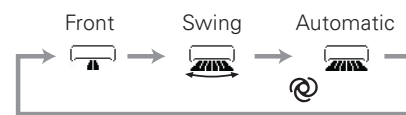

### Weekly Timer

The Weekly Timer enables the setting of operation start and finish times and adjusting the temperature as standard features. Up to 4 patterns per day can be set, providing operation that matches the varying conditions of each period, such as the number of customers in the store.

#### Example Operation Pattern (Winter/Heating mode)

	Mon.	Tues.	Wed.	Thurs.	Fri.	Sat.	Sun.
6:00	ON 20°C	ON 20°C	ON 20°C	ON 20°C	ON 20°C	ON 20°C	ON 20°C
8:00	Automatically changes to high-power operation at wake-up time						
10:00	OFF	OFF	OFF	OFF	OFF	ON 18°C	ON 18°C
12:00	Automatically turned off during work hours						
14:00	Midday is warmer, so the temperature is set lower						
16:00	ON 20°C	ON 20°C	ON 20°C	ON 20°C	ON 20°C	ON 20°C	ON 20°C
18:00	Automatically turns on, synchronized with arrival at home						
20:00	Automatically raises temperature setting to match time when outside-air temperature is low						
22:00 (during sleeping hours)	ON 18°C	ON 18°C	ON 18°C	ON 18°C	ON 18°C	ON 18°C	ON 18°C
	Automatically lowers temperature at bedtime for energy-saving operation at night						

\*Weekly Timer cannot be used when On/Off Timer is in use.

\*Only for SLZ-KF25/35/50/60VA2, PLA-ZP/35/50/60/71/100/125/140EA

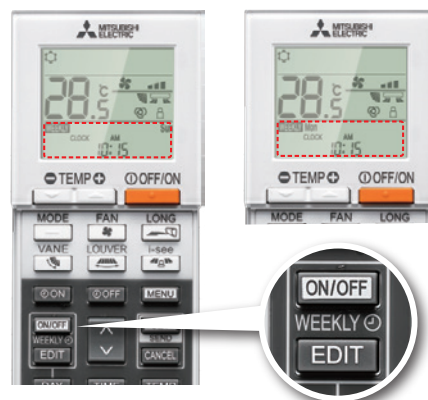

### Backlight

Backlight function incorporated, making screen easy to read in the dark. Even in dimly lit rooms, the screen can be seen clearly for trouble-free remote controller operation.



### Individual Vane Settings

The airflow directions of the four vanes can each be adjusted independently. Easily set the optimum airflow according to the room setting.

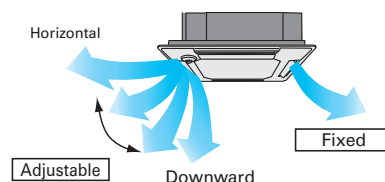
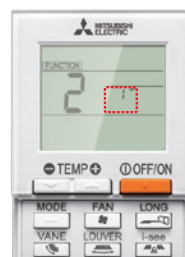

## Battery Replacement Sign

Previous wireless remote controllers were not easy to read, understand or use sometimes because the battery was low. Beginning with the PAR-SL101A-E, a battery charge indicator that shows the charge status is included in the LCD so it can be seen when the battery is low and needs to be changed.



## Dual Set Point

When the operation mode is set to the Auto (Dual Set Point) mode, two preset temperatures (one each for cooling and heating) can be set. Depending on the room temperature, the indoor unit will automatically operate in either the COOL or HEAT mode and keep the room temperature within the preset range.

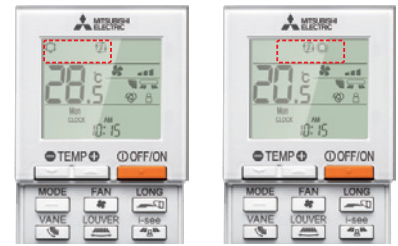

### Operation pattern during Auto (Dual Set Point) mode

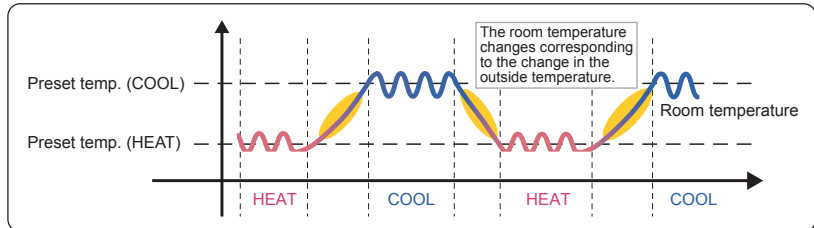

\* Only available for compatible models.

## 3D i-see Sensor (Direct/Indirect Airflow)

Pressing the i-see button enables direct or indirect setting of all vanes.

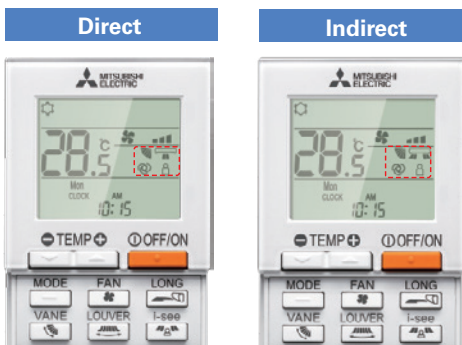

	Vane setting	
	Direct	Indirect
Cooling	horizontal → swing	keep horizontal
Heating	keep downward	downward → horizontal

### Direct Airflow

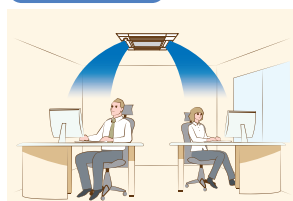

### Indirect Airflow

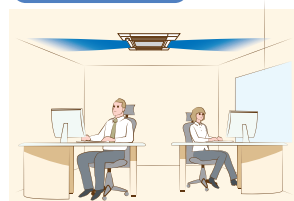

\* Only available for models equipped with 3D i-see Sensor.

## Basic Functions

Functions	Button	Liquid crystal
OFF / ON	OFF/ON	
Preset temperature	TEMP	88.5°C
Mode	MODE	Cool Dry Heat Fan Auto Dual set point *Dual Set Point function not operational first use.
Fan speed	FAN	4-Speed Auto
Vane angle	VANE	5-step Swing Auto
Louver	WIDE VANE	Fixed Swing
3D i-see Sensor	i-see	Direct Indirect
Send sign		
Battery replacement sign		
Function setting		FUNCTION
Test run		TEST
Self check		CHECK
Not available		N/A





\*This remote controller is only compatible with the following models: SLZ-M15/25/35/50/60FA, PLFY-P15/20/25/32/40/50VFM-E1, PLA-ZM/RP35/50/60/71/100/125/140EA, PLFY-P20/25/32/40/50/63/80/100/125VEM-E

\*Functions available vary according to the model.

# SYSTEM CONTROL

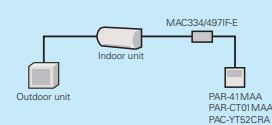
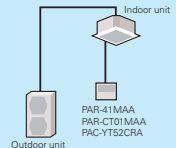
Versatile system controls can be realised using optional parts, relay circuits, control panels, etc.

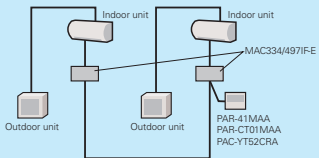
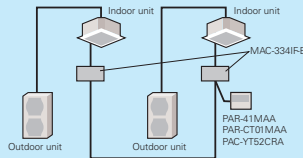
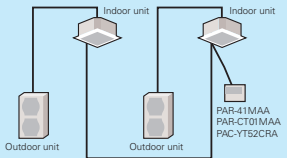
## MAJOR SYSTEM CONTROL

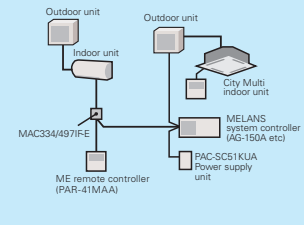
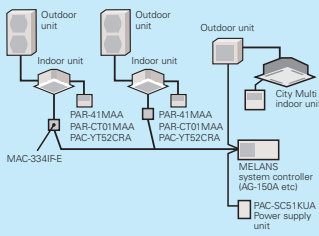
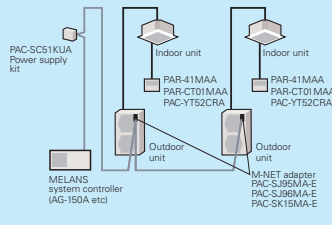
System Examples			
Indoor Unit	M Series Indoor Unit	S Series & P Series Indoor Unit	S Series & P Series
Outdoor Unit	M Series and MXZ Series Outdoor	S Series and MXZ Series Outdoor	P Series Outdoor
 <p><b>PAR-41MAA Control</b> <b>PAC-YT52CRA Control</b></p>			
Details	<ul style="list-style-type: none"> <li>Wired remote controller can be connected to indoor unit</li> </ul>	Standard equipment (for indoor units compatible with wired remote controllers)	
Major Optional Parts Required	<ul style="list-style-type: none"> <li>MAC334/497IF-E (Interface)</li> <li>PAR-41MAA (Wired remote controller)</li> <li>PAR-CT01MAA (Wired remote controller)</li> <li>PAC-YT52CRA (Wired remote controller)</li> </ul>	<ul style="list-style-type: none"> <li>PAR-41MAA (Wired remote controller)</li> <li>PAR-CT01MAA (Wired remote controller)</li> <li>PAC-YT52CRA (Wired remote controller)</li> </ul>	
 <p><b>System Group Control</b></p>			
Details	<ul style="list-style-type: none"> <li>One remote controller can control plural air conditioners with the same settings simultaneously.</li> <li>One remote controller can control up to 16 refrigerant systems. (When connected to a MXZ unit, MAC-334IFE is counted as one system.)</li> <li>Up to two remote controller can be connected.</li> <li>PAR-SL101A cannot be used when connected through the MAC-334IFE or when group control is used.</li> </ul>		
Major Optional Parts Required	<ul style="list-style-type: none"> <li>MAC334/497IF-E (Interface)</li> <li>PAR-41MAA (Wired remote controller)</li> <li>PAR-CT01MAA (Wired remote controller)</li> <li>PAC-YT52CRA (Wired remote controller)</li> </ul>		<ul style="list-style-type: none"> <li>PAR-41MAA (Wired remote controller)</li> <li>PAR-CT01MAA (Wired remote controller)</li> <li>PAC-YT52CRA (Wired remote controller)</li> </ul>
 <p><b>M-NET Connections</b></p>			
Details	<ul style="list-style-type: none"> <li>Group of air conditioners can be controlled by MELANS system controller (M-NET).</li> </ul>		
Major Optional Parts Required	<ul style="list-style-type: none"> <li>MAC334/497IF-E (M-NET Interface)</li> <li>MELANS System controller</li> <li>PAC-SC51KUA (power supply unit)</li> </ul>		<ul style="list-style-type: none"> <li>PAC-SJ95MA-E or PAC-SJ96MA-E (M-NET converter)</li> <li>MELANS System controller</li> <li>PAC-SC51KUA (power supply unit)</li> </ul>



## OTHERS

### For M Series Indoor Units (New A-control Models Only)

	System Examples	Connection Details	Control Details	Major Optional Parts Required
<b>1 Remote On/Off Operation</b> • Air conditioner can be started/stopped remotely. (1) and (2) can be used in combination		Connect the interface to the air conditioner. Then connect the locally purchased remote controller to the terminal in the interface.	On/Off operation is possible from a remote location.	<ul style="list-style-type: none"> <li>MAC-334IFE (Interface)</li> <li>Parts for circuit such as relay box, lead wire, etc. (to be purchased locally)</li> </ul>
<b>2 Remote Display of Operation Status</b> • The On/Off status of air conditioners can be confirmed remotely. (1) and (2) can be used in combination		Connect the interface to the air conditioner. Then connect the locally purchased remote controller to the terminal in the interface.	The operation status (On/Off) or error signals can be monitored from a remote location.	<ul style="list-style-type: none"> <li>MAC-334IFE (Interface)</li> <li>Parts for circuit to be purchased locally (DC power source needed)</li> <li>External power source (12V DC) is required when using MAC-334IFE.</li> </ul>

### For P Series and S Series Indoor Units

	System Examples		Details	Major Optional Parts Required
	Wired remote controller	Wireless remote controller		
<b>A 2-remote Controller Control</b> With two remote controllers, control can be performed locally and remotely from two locations.			<ul style="list-style-type: none"> <li>Up to two remote controllers can be connected to one group.</li> <li>Both wired and wireless remote controllers can be used in combination.</li> </ul>	<ul style="list-style-type: none"> <li>Wired Remote Controller PAR-41MAA PAC-YT52CRA (for PKA, PAC-SH29TC-E is required)</li> <li>Wireless Remote Controller PAR-SL97A-E / PAR-SL101A-E (only for SLZ)</li> <li>Wireless Remote Controller Kit for PCA PAR-SL94B-E</li> </ul>
<b>B Operation Control by Level Signal</b> Air conditioner can be started/stopped remotely. In addition, On/Off operation by local remote controller can be prohibited/permitted.			<ul style="list-style-type: none"> <li>Operation other than On/Off (e.g., adjustment of temperature, fan speed, and airflow) can be performed even when remote controller operation is prohibited.</li> <li>Timer control is possible with an external timer.</li> </ul>	<ul style="list-style-type: none"> <li>Adapter for remote On/Off PAC-SE55RA-E</li> <li>Relay box (to be purchased locally)</li> <li>Remote control panel (to be purchased locally)</li> </ul>
<b>C Operation Control by Pulse Signal</b>			<ul style="list-style-type: none"> <li>The pulse signal can be turned On/Off.</li> <li>Operation/emergency signal can be received at a remote location.</li> </ul>	<ul style="list-style-type: none"> <li>Connector cable for remote display PAC-SA88HA-E / PAC-725AD (10 pcs. x PAC-SA88HA-E)</li> <li>Relay box (to be purchased locally)</li> <li>Remote control panel (to be purchased locally)</li> </ul>
<b>D Remote Display of Operating Status</b> Operating status can be displayed at a remote location.			<ul style="list-style-type: none"> <li>Operation/emergency signal can be received at a remote location (when channeled through the PAC-SF40RM-E → no-voltage signal, when channeled through the PAC-SA88HA-E → DC 12V signal).</li> </ul>	<ul style="list-style-type: none"> <li>Remote display panel (to be purchased locally)</li> <li>Connector cable for remote display PAC-SA88HA-E / PAC-725AD (10 pcs. x PAC-SA88HA-E)</li> <li>Relay box (to be purchased locally)</li> <li>Remote operation adapter PAC-SF40RM-E</li> </ul> <p><small>* Unable to use with wireless remote controller</small></p>
<b>E Timer Operation</b> Allows On/Off operation with timer *For control by an external timer, refer to (B) Operation Control by Level Signal.			<ul style="list-style-type: none"> <li><b>Weekly Timer:</b> On/Off and up to 8 pattern temperatures can be set for each calendar day. (Initial setting)</li> <li><b>On/Off Timer:</b> On/Off can be set once each within 72 hr in intervals of 5-minute units.</li> <li><b>Auto-off Timer:</b> Operation will be switched off after a certain time elapse. Set time can be changed from 30 min. to 4 hr. at 10 min. intervals.</li> </ul> <p><small>*Simple Timer and Auto-off Timer cannot be used at the same time.</small></p>	Standard functions of PAR-41MAA / PAR-CT01MAA

# FUNCTION LIST (1)

Category	Icon	M SERIES										
		Combination	Indoor unit	MSZ-RW25/35/50VG	MSZ-LN18/25/35/50/60VG2 (W)(V)(R)(B)	MSZ-FT25/35/50VG	MSZ-AY15/20VGK(P)	MSZ-AY25/35/42/50VGK(P)	MSZ-AP60/71VG	MSZ-EF18/22/25/35/42/50VG(W)(B)(S)	MSZ-BT20/25/35/50VG	MSZ-HR25/35/42/50/60/71VF
			Outdoor unit	MUZ-RW	MUZ-LN	MUZ-FT	MUZ-AY	MUZ-AY	MUZ-AP	MUZ-EF	MUZ-BT	MUZ-HR
Technology		DC Inverter	●	●	●	●	●	●	●	●	●	
		Joint Lap DC Motor	●	●	●	●	●	●	●	●	●	
		Reluctance DC Rotary Compressor										
		Heating Caulking (Compressor)	●	●	●	●	●	●	●	●	●	
		DC Fan Motor	●	●	●	●	●	●	●	●	●	
		PAM (Pulse Amplitude Modulation)	●	●	●	●	●	●	●	●	●	
		Power Receiver and Twin LEV Control										
		Grooved Piping	●	●	●	●	●	●	●	●	●	
Functions	i-see Sensor	Felt Temperature Control (3D i-see Sensor)	●	●								
		AREA Temperature Monitor	●	●								
	Energy Saving	Econo Cool Energy-saving Feature	●	●	●	●	●	●	●	●	●	
		Standby Power Consumption Cut	●	●	●	●	●	●	●	●	●	
	Air Quality	Plasma Quad Plus	●	●		●*1	●*1					
		Plasma Quad										
		Dual Barrier Coating	●	●								
		Dual Barrier Material	●									
		Silver-ionized Air Purifier Filter		Opt	●	Opt	Opt	Opt	●	Opt	Opt	
		V Blocking Filter	Opt	Opt	●	●*2	●*2	●	●	●	Opt	
		Air Purifying Filter			●	●	●	●	●	●	●	
	Self Clean Mode				●	●						
	Air Distribution	Double Vane	●	●								
		Horizontal Vane	●	●	●	●	●	●	●	●	●	
		Vertical Vane	●	●	●		●	●				
		High Ceiling Mode										
		Auto Fan Speed Mode	●	●	●	●	●	●	●	●	●	
	Circulator Mode	●*3	●*3	●*3		●*3						
	Convenience	On/Off Operation Timer	●	●	●	●	●	●	●	●	●	
		"i save" Mode	●	●	●	●	●	●	●	●	●	
		Auto Changeover	●	●	●	●	●	●	●	●	●	
		Auto Restart	●	●	●	●	●	●	●	●	●	
		Low-temperature Cooling	●	●	●	●	●	●	●	●	●	
		10°C Heating	●	●	●	●	●	●		●		
		Low-noise Operation (Outdoor Unit)										
		Night Mode	●	●	●	●	●	●		●		
Ampere Limit Adjustment												
Operation Lock (Indoor)		●	●	●	●	●	●	●	●	●		
Operation Lock (Outdoor)												
Built-in Weekly Timer Function		●	●	●	●	●	●	●	●	●		
Drive Mode Selector	●											
System Control	PAR-41MAA Control *5	Opt	Opt	Opt	Opt	Opt	Opt	Opt	Opt	Opt		
	PAR-CT01MAA Control *5	Opt	Opt	Opt	Opt	Opt	Opt	Opt	Opt	Opt		
	PAC-YT52CRA Control *5	Opt	Opt	Opt	Opt	Opt	Opt	Opt	Opt	Opt		
	Centralised On/Off Control *5	Opt	Opt	Opt	Opt	Opt	Opt	Opt	Opt	Opt		
	System Group Control *5	Opt	Opt	Opt	Opt	Opt	Opt	Opt	Opt	Opt		
	M-NET Connection *5	Opt	Opt	Opt	Opt	Opt	Opt	Opt	Opt	Opt		
	Wi-Fi Interface *6	●	●	●	●	●	●	●	●	●		
	Energy Consumption Monitoring through MELCloud											
Installation	Cleaning-free Pipe Reuse	●	●	●	●	●	●	●	●	●		
	Wiring/Piping Correction Function											
	Drain Pump											
	Flare Connection	●	●	●	●	●	●	●	●	●		
Maintenance	Self-Diagnosis Function (Check Code Display)	●	●	●	●	●	●	●	●	●		
	Failure Recall Function	●	●	●	●	●	●	●	●	●		

\*1 Only VGKP model.

\*2 Equipped as standard for VGK model.

\*3 Available only for Scandinavian model.

\*4 When connected to MXZ outdoor units, the outdoor operating sound will not change.

\*5 Please refer to "System Control" on pages for details.

\*6 Only VGK model.

• The figures listed in the table are "only when combined with an outdoor unit with the appropriate capacity range".

• Opt: Separate parts must be purchased.

M SERIES					
	MSZ-DW25/35/ 50VF	MFZ-KT25/35/ 50/60VG	MFZ-KW25/35/ 50/60VG	MLZ-KP25/35/ 50VF	MLZ-KY20VG
	MUZ-DW	SUZ-M	MUFZ-KW	SUZ-M	Multi
	●	●	●	●	●
	●	●	●	●	●
	●	●	●	●	●
	●	●	●	●	●
	●	●	●	●	●
	●	●	●	●	●
	●	●	●	●	●
		●	●		●
	Opt	Opt	Opt	Opt	Opt
	Opt	●	●	Opt	●
	●	●	●	●	●
	●	●	●	●	●
				●	●
				●	●
	●	●	●	●	●
		●	●	●	●
				●	●
		●	●	●	●
	Opt	Opt	Opt	Opt	Opt
	Opt	Opt	Opt	Opt	Opt
	Opt	Opt	Opt	Opt	Opt
	Opt	Opt	Opt	Opt	Opt
	Opt	Opt	Opt	Opt	Opt
	Opt	Opt	Opt	Opt	Opt
	●	Opt	Opt	Opt	Opt
	●	●	●	●	●
				●	●
				●	●
	●	●	●	●	●
	●	●	●	●	●
	●	●	●	●	●

# FUNCTION LIST (2)

Category	Icon	S SERIES						P SERIES				
		Combination	Indoor unit	SLZ-M15/25/35/50/60FA2 *1		SEZ-M25/35/50/60/71DA(L)2		SFZ-M25/35/50/60/71VA	PLA-ZM35/50/60/71/100/125/140EA2	PLA-M35/50/60/71/100/125/140EA2		
			Outdoor unit	SUZ-M	PUZ-ZM	SUZ-M	PUZ-ZM	SUZ-M	PUZ-ZM	PUZ-ZM	SUZ-M	PUZ-M
Function merit-up		3D Total Flow						●	●		●	
		2+1 Back-up rotation		●		●		●	●		●	
		Extended cooling set temperature range						●	●		●	
		Display of model names and serial numbers		●		●		●	●		●	
		Display of power consumption	●	●	●	●	●	●	●	●	●	
		Avoiding simultaneous defrosting		●		●		●	●		●	
		Defrosting when people are absent		●				●	●			
		Defrosting when operation is stopped		●		●		●	●			
		Collection of operation data via MELCloud		●		●		●	●		●	
		Demand control via MELCloud		●		●		●	●		●	
	Notification of potential abnormality via MELCloud		●		●		●	●		●		
Technology		DC Inverter	●	●	●		●	●	●	●	●	
		Joint Lap DC Motor	●		●		●	35-71	35-71	●	100	
		Magnetic Flux Vector Sine Wave Drive		●				●	●		●	
		Reluctance DC Rotary Compressor	●		●		●	35-71	35-71	●	100-140	
		Highly Efficient DC Scroll Compressor		●				100-250	100-250		200-250	
		Heating Caulking (Compressor)	●		●		●	35-71	35-71	●	100	
		DC Fan Motor	●	●	●		●	●	●	●	●	
		Vector-Wave Eco Inverter		●				●	●		●	
		PAM (Pulse Amplitude Modulation)	●	●	●		●	35-140	35-140	●	100-140V	
		Power Receiver and Twin LEV Control		●				35-250	35-250		100-250	
	Grooved Piping	●	●	●		●	●	●	●	●		
Functions	i-see Sensor	Felt Temperature Control (3D i-see Sensor)	Opt	Opt				Opt	Opt	Opt	Opt	
		AREA Temperature Monitor	Opt	Opt				Opt	Opt	Opt	Opt	
	Energy Saving	Demand Function						Opt	Opt		Opt	
	Attractive	Pure White	●	●				●	●	●	●	
		Auto Vane	●	●				●	●	●	●	
	Air Quality	Fresh-air Intake	●	●				●	●	●	●	
		High-efficiency Filter						Opt	Opt	Opt	Opt	
		Oil Mist Filter										
		Long-life Filter	●	●				●	●	●	●	
		Filter Check Signal	●	●				●	●	●	●	
	Air Distribution	Horizontal Vane	●	●				●	●	●	●	
		Vertical Vane										
		High Ceiling Mode	●	●				●	●	●	●	
		Low Ceiling Mode						●	●	●	●	
		Auto Fan Speed Mode	●	●	●		●	●	●	●	●	
	Convenience	On/off Operation Timer	●	●	●		●	●	●	●	●	
		Auto Changeover	●	●	●		●	●	●	●	●	
		Auto Restart	●	●	●		●	●	●	●	●	
		Low-temperature Cooling	●	●	●		●	●	●	●	●	
		Low-noise Operation (Outdoor Unit)		●				●	●		●	
		Ampere Limit Adjustment		60-140V				60-140V 200/250	60-140V 200/250			
		Operation Lock										
		Rotation, Back-up and 2nd Stage Cut-in Functions		●				●	●		●	
	Dual Set Point *2		●				●	●		●		
	System Control	PAR-41MAA Control *3	Opt	Opt	Opt		Opt	Opt	Opt	Opt	Opt	
		PAR-CT01MAA Control *3	Opt	Opt	Opt		Opt	Opt	Opt	Opt	Opt	
		PAC-YT52CRA Control *3	Opt	Opt	Opt		Opt	Opt	Opt	Opt	Opt	
Centralised On/Off Control *3		Opt	Opt	Opt		Opt	Opt	Opt	Opt	Opt		
System Group Control *3		Opt	Opt	Opt		Opt	●	●	Opt	●		
M-NET Connection *3		Opt		Opt		Opt	Opt	Opt	Opt	Opt		
COMPO			71-140				71-250	71-250		●		
Installation	Cleaning-free Pipe Reuse	●	●	●		●	●	●	●	●		
	Reuse of Existing Wiring						Opt	Opt		Opt		
	Wiring/Piping Correction Function											
	Drain Pump	●	●	Opt			●*4	●*4	●*4	●*4		
	Pump Down Switch						●	●		●		
	Flare Connection	●	●	●		●	●	●	●	●		
Maintenance	Self-Diagnosis Function (Check Code Display)	●	●	●		●	●	●	●	●		
	Failure Recall Function	●	●	●		●	●	●	●	●		

\*1 SLZ-M15 can be connected with R32 MXZ only.

\*2 This function is only available with PAR-41MAA, PAC-YT52CRA, PAR-SL101A-E.

\*3 Please refer to "System Control" on pages for details.

\*4 PEAD-M JAL are not equipped with a drain pump.

● If a numerical figure is listed, the feature is only available with the outdoor unit of that capacity.  
● Opt: Optional parts must be purchased.



# FUNCTION LIST (3)

Category	Icon	P SERIES										
		Combination	Indoor unit	PEAD-M35/50/60/71/100/125/140JA(L)2			PEA-M200/250LA2		PKA-M35/50LA(L)2		PKA-M60/71/100KA(L)2	
			Outdoor unit	PUZ-ZM	PUZ-M	SUZ-M	PUZ-ZM	PUZ-M	PUZ-ZM	PUZ-M	PUZ-ZM	PUZ-M
Function merit-up	3D Total Flow											
	2+1 Back-up rotation		●	●		●	●	●	●	●	●	
	Extended cooling set temperature range							●	●	●	●	
	Display of model names and serial numbers		●	●		●	●	●	●	●	●	
	Display of power consumption		●	●	●	●	●	●	●	●	●	
	Avoiding simultaneous defrosting		●	●		●	●	●	●	●	●	
	Defrosting when people are absent											
	Defrosting when operation is stopped		●			●		●		●		
	Collection of operation data via MELCloud		●	●		●	●	●	●	●	●	
	Demand control via MELCloud		●	●		●	●	●	●	●	●	
Notification of potential abnormality via MELCloud		●	●		●	●	●	●	●	●		
Technology	DC Inverter		●	●	●	●	●	●	●	●	●	
	Joint Lap DC Motor		35-71	100	●			35-71	100	60/71	100	
	Magnetic Flux Vector Sine Wave Drive		●	●		●	●	●	●	●	●	
	Reluctance DC Rotary Compressor		35-71	100-140	●			35-71	●	60/71	100-140	
	Highly Efficient DC Scroll Compressor		100-250	200/250		●	●	100-200		100-250	200/250	
	Heating Caulking (Compressor)		35-71	100	●			35-71		60/71	100	
	DC Fan Motor		●	●	●	●	●	●	●	●	●	
	Vector-Wave Eco Inverter		●	●		●	●	●	●	●	●	
	PAM (Pulse Amplitude Modulation)		35-140	100-140V	●			35-140	100V-140V	60-140	100-140V	
	Power Receiver and Twin LEV Control		35-250	100-250		●	●	35-200	100-140	60-250	100-250	
Grooved Piping		●	●	●	●	●	●	●	●	●		
Functions	I-see Sensor	Felt Temperature Control (3D I-see Sensor)										
		AREA Temperature Monitor										
	Energy Saving	Demand Function	Opt	Opt		Opt	Opt	Opt	Opt	Opt	Opt	
		Attractive							●	●	●	●
	Air Quality	Pure White							●	●	●	●
		Auto Vane							●	●	●	●
		Fresh-air Intake										
		High-efficiency Filter										
		Oil Mist Filter										
	Air Distribution	Long-life Filter	●	●	●	Opt	Opt					
		Filter Check Signal	●	●	●	●	●	Opt	Opt	Opt	Opt	
		Horizontal Vane							●	●	●	●
		Vertical Vane										
		High Ceiling Mode										
	Convenience	Low Ceiling Mode										
		Auto Fan Speed Mode	●	●	●	●	●	●	●	●	●	●
		On/off Operation Timer	●	●	●	●	●	●	●	●	●	●
		Auto Changeover	●	●	●	●	●	●	●	●	●	●
		Auto Restart	●	●	●	●	●	●	●	●	●	●
		Low-temperature Cooling	●	●	●	●	●	●	●	●	●	●
Low-noise Operation (Outdoor Unit)		●	●		●	●	●	●	●	●	●	
Ampere Limit Adjustment		60-140V						71-140V		60-140V		
Operation Lock												
Rotation, Back-up and 2nd Stage Cut-in Functions		●	●		●	●	●	●	●	●	●	
Dual Set Point *1	●	●		●	●	●	●	●	●	●		
System Control	PAR-41MAA Control *2	Opt	Opt	Opt	Opt	Opt	Opt	Opt	Opt	Opt	Opt	
	PAR-CT01MAA Control *2	Opt	Opt	Opt	Opt	Opt	Opt	Opt	Opt	Opt	Opt	
	PAC-YT52CRA Control *2	Opt	Opt	Opt	Opt	Opt	Opt	Opt	Opt	Opt	Opt	
	Centralised On/Off Control *2	Opt	Opt	Opt	Opt	Opt	Opt	Opt	Opt	Opt	Opt	
	System Group Control *2	●	●	Opt	●	●	●	Opt	Opt	Opt	Opt	
	M-NET Connection *2	Opt	Opt	Opt	Opt	Opt	Opt	Opt	Opt	Opt	Opt	
	COMPO	71-250	●		●	●	●	71-200	●	71-250	●	
Installation	Cleaning-free Pipe Reuse	●	●	●	●	●	●	●	●	●	●	
	Reuse of Existing Wiring	Opt	Opt					Opt	Opt	Opt	Opt	
	Wiring/Piping Correction Function											
	Drain Pump	●*3	●*3	●*3	Opt	Opt	Opt	Opt	Opt	Opt	Opt	
	Pump Down Switch	●	●		●	●	●	●	●	●	●	
	Flare Connection	●	●	●	●	●	●	●	●	●	●	
Maintenance	Self-Diagnosis Function (Check Code Display)	●	●	●	●	●	●	●	●	●	●	
	Failure Recall Function	●	●	●	●	●	●	●	●	●	●	

\*1 This function is only available with PAR-41MAA, PAC-YT52CRA, PAR-SL101A-E.

\*2 Please refer to "System Control" on pages for details.

\*3 PEAD-M JAL are not equipped with a drain pump.

P SERIES							
	PCA-M35/50/60/71/100/125/140KA2			PCA-M71HA2	PSA-M71/100/125/140KA		
	PUZ-ZM	PUZ-M	SUZ-M	PUZ-ZM	PUZ-ZM	PUZ-M	SUZ-M
	●	●		●			
	●	●		●	●	●	
	●	●		●	●	●	
	●	●	●	●	●	●	●
	●	●		●	●	●	
	●						
	●			●	●		
	●	●		●	●	●	
	●	●		●	●	●	
	●	●	●	●	●	●	●
	35-71	100	●	71	71	100	●
	●	●		●	●	●	
	35-71	100-140	●	71	71	100-140	●
	100-250	200/250		100-250	200-250	200/250	
	35-71	100	●	71	71	100	●
	●	●	●	●	●	●	●
	●	●		●	●	●	
	35-140	100-140V	●	71-140	71-140	100-140V	●
	35-250	100-250		71-250	71-250	100-250	
	●	●	●	●	●	●	●
	Opt	Opt		Opt	Opt	Opt	
	●	●	●		●	●	●
	●	●	●				
	●	●	●	●			
	Opt	Opt	Opt				
				●			
	●	●	●		●	●	●
	●	●	●	●	●	●	●
	●	●	●				
	●	●	●	●	●	●	●
	●	●	●	●	●	●	●
	●	●	●	●	●	●	●
	●	●	●	●	●	●	●
	60-140V				71-140V		
	●	●		●	●	●	●
	●	●					
	Opt	Opt	Opt	Opt	●	●	●
	Opt	Opt	Opt	Opt			
	Opt	Opt	Opt	Opt			
	Opt	Opt	Opt	Opt	Opt	Opt	Opt
	●	●	Opt	●	Opt	Opt	Opt
	Opt	Opt	Opt	Opt	Opt	Opt	Opt
	71-250	●		71-250	71-250		
	●	●	●	●	●	●	●
	Opt	Opt		Opt	Opt	Opt	
	Opt	Opt	Opt				
	●	●		●			
	●	●	●	●	●	●	●
	●	●	●	●	●	●	●
	●	●	●	●	●	●	●

● If a numerical figure is listed, the feature is only available with the outdoor unit of that capacity.  
 ● Opt: Optional parts must be purchased.

# FUNCTION LIST (4)

Category	Icon	Series Outdoor unit	MXZ SERIES									PXZ SERIES		
			Lo-std		Std			Std			Hyper Heating		PXZ-VG	
			MXZ-VF2		MXZ-VF4			MXZ-VF2			MXZ-VFHZ2		PXZ-VG	
			2HA	3HA	2F	3F	4F	4F	5F	6F	2F	4F	4F75	5F85
Technology	DC Inverter		●	●	●	●	●	●	●	●	●	●	●	●
	Joint Lap DC Motor		●	●	●	●	●	●	●	●	●	●	●	●
	Magnetic Flux Vector Sine Wave Drive													
	Reluctance DC Rotary Compressor											●	●	
	Highly Efficient DC Scroll Compressor													
	Heating Caulking (Compressor)		●	●	●	●	●	●	●	●	●	●	●	●
	DC Fan Motor		●	●	●	●	●	●	●	●	●	●	●	●
	Vector-Wave Eco Inverter													
	PAM (Pulse Amplitude Modulation)		●	●	●	●	●	●	●	●	●	●	●	●
	Power Receiver and Twin LEV Control			●		●	●							
Grooved Piping		●	●	●	●	●	●	●	●	●	●	●	●	
Functions	i-see Sensor	Felt Temperature Control (3D i-see)												
		AREA Temperature Monitor												
	Energy Saving	Demand Function												
		Attractive	Pure White											
	Auto Vane													
	Air Quality	Fresh-air Intake												
		High-efficiency Filter												
		Oil Mist Filter												
		Filter Check Signal												
	Air Distribution	Horizontal Vane												
		Vertical vane												
		High Ceiling Mode												
		Auto Fan Speed Mode												
	Convenience	On/off Operation Timer												
		Auto Changeover		●	●	●	●	●	●	●	●	●	●	●
		Auto Restart		●	●	●	●	●	●	●	●	●	●	●
		Low- temperature Cooling		●	●	●	●	●	●	●	●	●	●	●
		10°C Heating				●*1	●*1	●*1	●*1	●*1	●*1	●*1	●*1	●*1
		Low-noise Operation (Outdoor)		●	●	●	●	●	●	●	●	●	●	●
		Night Mode												
		Ampere Limit Adjustment											●	●
		Operation Lock (Indoor)												
		Operation Lock (Outdoor)		●	●	●	●	●	●	●	●	●	●	●
	System Control	PAR-41MAA Control		Opt	Opt	Opt	Opt	Opt	Opt	Opt	Opt	Opt	Opt	Opt
		PAR-CT01MAA Control		Opt	Opt	Opt	Opt	Opt	Opt	Opt	Opt	Opt	Opt	Opt
		PAC-YT52CRA Control		Opt	Opt	Opt	Opt	Opt	Opt	Opt	Opt	Opt	Opt	Opt
Centralised On/off Control			Opt	Opt	Opt	Opt	Opt	Opt	Opt	Opt	Opt	Opt	Opt	
System Group Control			Opt	Opt	Opt	Opt	Opt	Opt	Opt	Opt	Opt	Opt	Opt	
M-NET Connection													Opt	
Wi-Fi Interface													Opt	
Energy/Consumption Monitoring through MEL Cloud													Opt	
COMPO													Opt	
MXZ Connection			●*2	●*2	●*2	●*2	●*2	●*2	●*2	●*2	●*2	●*2	●*2	
Installation	Cleaning-free Pipe Reuse		●*3	●*3	●*3	●*3	●*3	●*3	●*3	●*3	●*3	●*3	●*3	
	Reuse of Existing Wiring													
	Wiring/Piping Correction Function		●	●	●	●	●	●	●	●	●	●	●	
	Drain Pump													
	Pump Down Switch			●		●	●							
	Flare Connection		●	●	●	●	●					●	●	
Maintenance	Self-Diagnosis Function (Check Code Display)		●	●	●	●	●					●	●	
	Failure Recall Function		●	●	●	●	●					●	●	

\*1 When multiple indoor units connected to an MXZ outdoor unit are running at the same time, simultaneous cooling and heating is not possible.

\*2 For the possible connectivity of MXZ outdoor units and indoor units, please refer to the list on page 116 for details.

\*3 Please refer to "System Control" on pages for details.

• The figures listed in the table are "only when combined with an outdoor unit with the appropriate capacity range".



• Opt: Separate parts must be purchased.





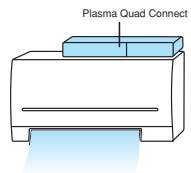
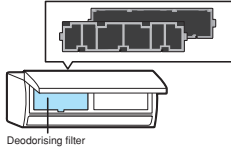
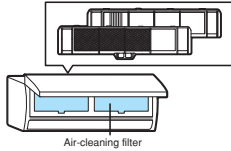
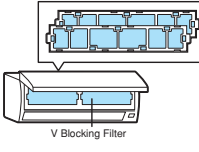
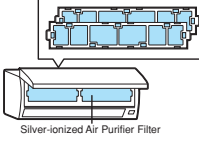
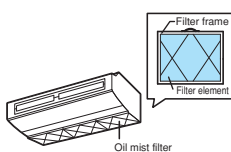
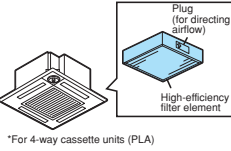
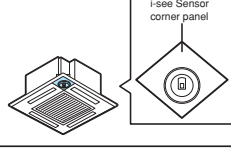
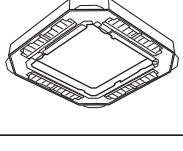
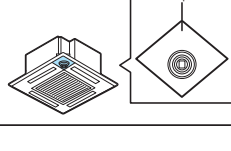
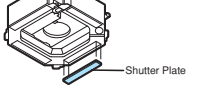

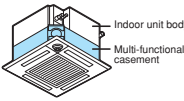
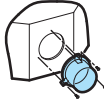
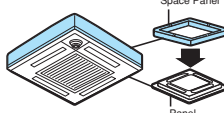
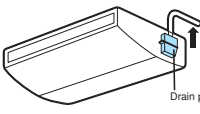
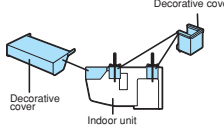
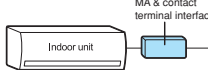
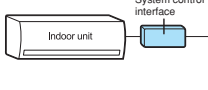
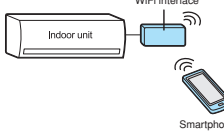
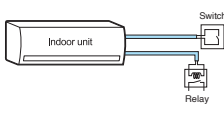
# Major Optional Parts

Part Name	Description
<b>Plasma Quad Connect</b> High performance air purifying device that effectively removes various kinds of air pollutants and is even installable on the existing indoor unit.	 <p>Plasma Quad Connect</p>
<b>Deodorising Filter</b> Captures small foul-smelling substances in the air.	 <p>Deodorising filter</p>
<b>Air-cleaning Filter</b> Removes fine dust particles from the air by means of static electricity.	 <p>Air-cleaning filter</p>
<b>V Blocking Filter</b> Inhibits 99% of adhered virus, and other harmful substances, such as bacteria, mold and allergen.	 <p>V Blocking Filter</p>
<b>Silver-ionized Air Purifier Filter</b> Captures the bacteria, pollen and other allergens in the air and neutralises them.	 <p>Silver-ionized Air Purifier Filter</p>
<b>Oil Mist Filter Element</b> Filter element (12 pieces) that blocks the oil mist for ceiling-suspended models used in professional kitchens.	 <p>Oil mist filter</p>
<b>High-efficiency Filter Element</b> Element for high-efficiency filter. Removes fine dust particles from the air.	 <p>High-efficiency filter element</p> <p>*For 4-way cassette units (PLA)</p>
<b>3D i-see Sensor Corner Panel for SLZ</b> Corner panel holding the 3D i-see Sensor.	 <p>i-see Sensor corner panel</p>
<b>3D Total Flow for PLA</b> Casement equipped with horizontal louver.	
<b>3D i-see Sensor Corner Panel for PLA</b> Corner panel holding the 3D i-see Sensor.	 <p>i-see Sensor corner panel</p>
<b>Shutter Plate</b> Plate for blocking an air outlet of the 4-way cassette (PLA) indoor unit.	 <p>Shutter Plate</p>

Part Name	Description
<b>Multi-functional Casement</b> Casement for fresh-air intake and attaching the high-efficiency filter element (optional).	 <p>Indoor unit body Multi-functional casement</p>
<b>Fresh-air Intake Duct Flange</b> Flange attachment for adding a duct to take in fresh air from outside.	 <p>*For 4-way cassette units (PLA)</p>
<b>Space Panel</b> Decorative cover for the installation when the ceiling height is low.	 <p>Space Panel Panel</p>
<b>Drain Pump</b> Pumps drain water to a point higher than that where the unit is installed.	 <p>Drain pump</p> <p>*for ceiling-suspended units</p>
<b>Decorative Cover</b> To be attached to the upper section of ceiling-suspended models for professional kitchen use. Helps prevent dust accumulation.	 <p>Decorative cover Indoor unit</p>
<b>MA Interface</b> Interface for connecting with the PAR-41MAA remote controller and PAC-YT52CRA.	 <p>MA &amp; contact terminal interface Indoor unit</p>
<b>System Control Interface</b> Interface to connect with M-NET controllers.	 <p>System control interface Indoor unit</p>
<b>Wi-Fi Interface</b> Interface enabling users to control air conditioners and check operating status via devices such as personal computers, tablets and smartphones.	 <p>WiFi interface Indoor unit Smartphone</p>
<b>Connector Cable</b> This product is an adaptor which inputs the incoming signals from an open/close switch to the air conditioner and outputs the on/off signals from the air conditioner.	 <p>Indoor unit Switch Relay</p>
<b>Power Supply Terminal Kit</b> Terminal bed to change the power supply from outdoor power supply to separate indoor/outdoor power supplies.	
<b>Wired Remote Controller</b> Advanced deluxe remote controller with full-dot liquid-crystal display and backlight. Equipped with convenient functions like night-setback.	

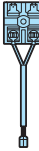
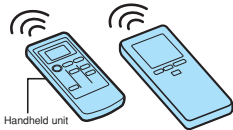
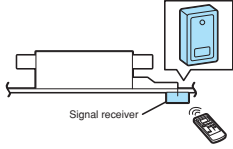
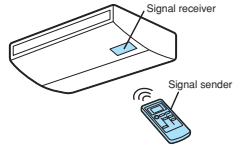
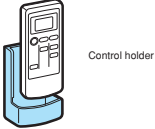
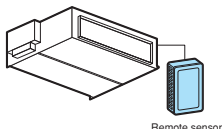
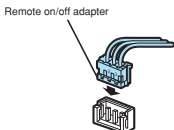
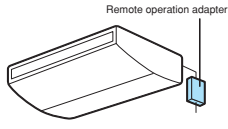
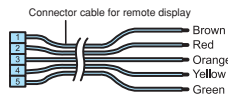
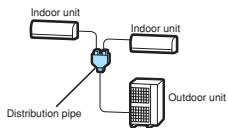
Part Name	Description
<b>MA Touch Remote Controller</b> Remote controller with the full color touch display. Smartphone/Tablet App is available for setting, customize and control.	
<b>Simple Wired Remote Controller</b> Remote controller with liquid-crystal display, and backlight function for operation in dark location.	
<b>Remote Controller Terminal Block Kit for PKA</b> The terminal block is used as a relay to wire an indoor unit and to two remote controllers or to wire a remote controller and multiple indoor units in order to perform group control.	
<b>Wireless Remote Controller Signal Sender</b> Handheld unit for sending operation signals to the indoor unit.	
<b>Wireless Remote Controller Signal Receiver</b> Receives operation signals from the wireless remote controller handheld unit.	
<b>Wireless Remote Controller Kit (Sender &amp; Receiver)</b> Remote controller handheld unit (signal sender) and receiver (signal receiver) for ceiling-suspended units.	
<b>Control Holder</b> Holder for storing the remote controller.	
<b>Remote Sensor</b> Sensor to detect the room temperature at remote positions.	
<b>Remote On/Off Adapter</b> Connector for receiving signals from the local system to control the on/off function.	
<b>Remote Operation Adapter</b> Adapter to display the operation status and control on/off function from a distance.	
<b>Connector Cable for Remote Display</b> Connector used to display the operation status and control on/off function from a distance.	
<b>Distribution Pipe</b> Branch pipe for P Series simultaneous multi-system use, or to connect two branch boxes for PUMY.	

\*P Series with 2 indoor units

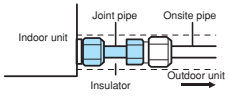
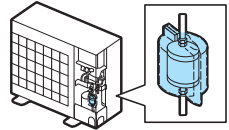
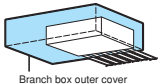
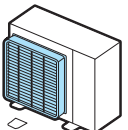
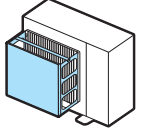
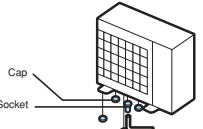
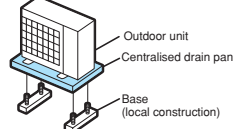
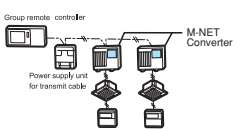
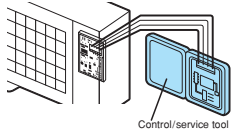
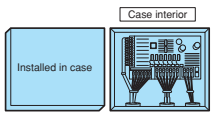
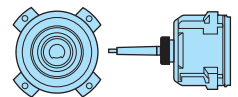
Part Name	Description
<b>Joint Pipe</b> Part for connecting refrigerant pipes of different diameters.	
<b>Liquid Refrigerant Dryer</b> Removes water and minute particles from refrigerant pipes.	
<b>Branch Box Outer Cover</b> Casement for branch boxes.	
<b>Air Discharge Guide</b> Changes the direction of air being exhausted from the outdoor unit.	
<b>Air Protection Guide</b> Protects the outdoor unit from the wind.	
<b>Drain Socket</b> A set of caps to cover unnecessary holes at the bottom of the outdoor unit, and a socket to guide drain water to the local drain pipe.	
<b>Centralised Drain Pan</b> Catches drain water generated by the outdoor unit.	
<b>M-NET Converter</b> Used to connect P Series A-control models to M-NET controllers.	
<b>Control/Service Tool</b> Monitoring tool to display operation and self-diagnosis data.	
<b>Step Interface</b> Interface for adjusting the capacity of inverter-equipped outdoor units.	
<b>High-static Fan Motor</b> Static pressure enhanced up to +30pa.	









# Optional Parts List <Indoor>

Indoor Unit		Option	Fresh-air Intake Duct Flange		Space Panel	Drain Pump						Decorative Cover	System Control Interface	Wi-Fi Interface	
			PAC-SH65 OF-E	PAC-SF28 OF-E	PAC-SJ65 AS-E	PAC-SK19 DM-E	PAC-SK01 DM-E	PAC-SJ92 DM-E	PAC-SJ93 DM-E	PAC-SJ94 DM-E	PAC-KE07 DM-E	PAC-KE06 DM-FI	PAC-SF81 KC-E	MAC-334 IF-E	MAC-587 IF-E
S SERIES	4-way cassette	SLZ-M15FA2												●	●
		SLZ-M25FA2												●	●
		SLZ-M35FA2												●	●
		SLZ-M50FA2												●	●
		SLZ-M60FA2												●	●
	Ceiling - concealed	SEZ-M25DA(L)2									●			●	●
		SEZ-M35DA(L)2									●			●	●
		SEZ-M50DA(L)2									●			●	●
		SEZ-M60DA(L)2									●			●	●
		SEZ-M71DA(L)2									●			●	●
	Concealed floor standing	SFZ-M25VA												●	●
		SFZ-M35VA												●	●
		SFZ-M50VA												●	●
		SFZ-M60VA												●	●
		SFZ-M71VA												●	●
P SERIES	4-way cassette	PLA-ZM35EA2	●		●									● <sup>*1</sup>	●
		PLA-ZM50EA2	●		●									● <sup>*1</sup>	●
		PLA-ZM60EA2	●		●									● <sup>*1</sup>	●
		PLA-ZM71EA2	●		●									● <sup>*1</sup>	●
		PLA-ZM100EA2	●		●									● <sup>*1</sup>	●
		PLA-ZM125EA2	●		●									● <sup>*1</sup>	●
		PLA-ZM140EA2	●		●									● <sup>*1</sup>	●
		PLA-M35EA2	●		●									● <sup>*1</sup>	●
		PLA-M50EA2	●		●									● <sup>*1</sup>	●
		PLA-M60EA2	●		●									● <sup>*1</sup>	●
		PLA-M71EA2	●		●									● <sup>*1</sup>	●
		PLA-M100EA2	●		●									● <sup>*1</sup>	●
		PLA-M125EA2	●		●									● <sup>*1</sup>	●
	PLA-M140EA2	●		●									● <sup>*1</sup>	●	
	Ceiling - concealed	PEAD-M35JA(L)2												● <sup>*1</sup>	●
PEAD-M50JA(L)2													● <sup>*1</sup>	●	
PEAD-M60JA(L)2													● <sup>*1</sup>	●	
PEAD-M71JA(L)2													● <sup>*1</sup>	●	
PEAD-M100JA(L)2													● <sup>*1</sup>	●	
PEAD-M125JA(L)2													● <sup>*1</sup>	●	
PEAD-M140JA(L)2													● <sup>*1</sup>	●	
PEA-M200LA2											●		● <sup>*1</sup>	●	
PEA-M250LA2											●		● <sup>*1</sup>	●	
Wall - mounted	PKA-M35LA(L)2						●						● <sup>*1</sup>	●	
	PKA-M50LA(L)2						●						● <sup>*1</sup>	●	
	PKA-M60KA(L)2				●								● <sup>*1</sup>	●	
	PKA-M71KA(L)2				●								● <sup>*1</sup>	●	
	PKA-M100KA(L)2				●								● <sup>*1</sup>	●	
Ceiling - suspended	PCA-M35KA2						●						● <sup>*1</sup>	●	
	PCA-M50KA2						●						● <sup>*1</sup>	●	
	PCA-M60KA2								●				● <sup>*1</sup>	●	
	PCA-M71KA2									●			● <sup>*1</sup>	●	
	PCA-M100KA2									●			● <sup>*1</sup>	●	
	PCA-M125KA2									●			● <sup>*1</sup>	●	
	PCA-M140KA2									●			● <sup>*1</sup>	●	
	PCA-M71HA2		●									●	● <sup>*1</sup>	●	
Floor - standing	PSA-M71KA													●	
	PSA-M100KA													●	
	PSA-M125KA													●	
	PSA-M140KA													●	

\*1 P Series indoor units can be used in combination with SUZ or MXZ outdoor units. \*2 Unable to use with wireless remote controller. \*3 PAC-SH29TC-E is required for wireless model.





# Optional Parts List <Outdoor>

Outdoor Unit		Option	Distribution Pipe						Joint Pipe						Liquid Refrigerant Dryer				
			For Twin (50:50)		For Triple (33:33:33)		For Quadruple (25:25:25:25)		Unit ø6.35 --> Pipe ø9.52	Unit ø9.52 --> Pipe ø12.7	Unit ø15.88 --> Pipe ø19.05	Unit ø9.52 --> Pipe ø15.88	Unit ø6.35 --> Pipe ø9.52	Unit ø9.52 --> Pipe ø12.7	Unit ø12.7 --> Pipe ø9.52	Unit ø12.7 --> Pipe ø15.88	For Pipe ø6.35	For Pipe ø9.52	For Pipe ø12.7
			MSDD-50TR-E	MSDD-50WR-E	MSDT-111R-E	MSDT-111R3-E	MSDF-111R-E	MSDF-111R2-E	PAC-SG72 RJ-E	PAC-SG73 RJ-E	PAC-SG75 RJ-E	PAC-SG76 RJ-E	PAC-493 PI	Flare MAC-A454 JP-E	MAC-A455 JP-E	MAC-A456 JP-E	PAC-SG81 DR-E	PAC-SG82 DR-E	PAC-SG85 DR-E
M SERIES	RW Series	MUZ-RW25VGHZ																	
		MUZ-RW35VGHZ																	
		MUZ-RW50VGHZ																	
	L Series	MUZ-LN25VG2																	
		MUZ-LN25VGHZ2																	
		MUZ-LN35VG2																	
		MUZ-LN35VGHZ2																	
		MUZ-LN50VG2																	
		MUZ-LN50VGHZ2																	
	FT Series	MUZ-LN60VG2																	
		MUZ-FT25VGHZ																	
		MUZ-FT35VGHZ																	
	A Series	MUZ-FT50VGHZ																	
		MUZ-AY15VG																	
		MUZ-AY20VG																	
		MUZ-AY25VG																	
		MUZ-AY25VGH																	
		MUZ-AY35VG																	
		MUZ-AY35VGH																	
		MUZ-AY42VG																	
		MUZ-AY42VGH																	
		MUZ-AY50VG																	
		MUZ-AY50VGH																	
	E Series	MUZ-AP60VG																	
		MUZ-AP71VG2																	
		MUZ-EF25VG																	
		MUZ-EF25VGH																	
		MUZ-EF35VG																	
	BT Series	MUZ-EF35VGH																	
		MUZ-EF42VG																	
		MUZ-EF50VG																	
		MUZ-BT20VG																	
	HR Series	MUZ-BT25VG																	
		MUZ-BT35VG																	
		MUZ-BT50VG																	
	DW Series	MUZ-HR25VF																	
		MUZ-HR35VF																	
		MUZ-HR42VF																	
		MUZ-HR50VF																	
		MUZ-HR60VF																	
	TP Series	MUZ-HR71VF																	
		MUZ-DW25VF																	
	F Series	MUZ-DW35VF																	
		MUZ-DW50VF																	
		MUY-TP35VF																	
		MUY-TP50VF																	
		MUZ-FH25VE																	
	S Series	MUZ-FH25VEHZ																	
		MUZ-FH35VE																	
		MUZ-FH35VEHZ																	
		MUZ-FH50VE																	
		MUZ-FH50VEHZ																	
		MUZ-SF25VE																	
		MUZ-SF25VEH																	
	G Series	MUZ-SF35VE																	
		MUZ-SF35VEH																	
		MUZ-SF42VE																	
		MUZ-SF42VEH																	
	W Series	MUZ-SF50VE																	
		MUZ-SF50VEH																	
	D Series	MUZ-GF60VE																	
		MUZ-GF71VE																	
	H Series	MUZ-WN25VA																	
		MUZ-WN35VA																	
		MUZ-DM25VA																	
		MUZ-DM35VA																	
	Compact floor	MUZ-HJ25VA																	
		MUZ-HJ35VA																	
		MUZ-HJ50VA																	
		MUZ-HJ60VA																	
		MUZ-HJ71VA																	
	Compact floor	MUFZ-KW25VGHZ																	
		MUFZ-KW35VGHZ																	
		MUFZ-KW50VGHZ																	
		MUFZ-KW60VGHZ																	

Air Outlet Guide									Air Protection Guide			Drain Socket			Freeze-prevention Heater (for Drain Pan)			Centralized Drain Pan			M-NET Adapter	M-NET Converter		Control/Service Tool	Step Interface 1 PC board w/attachment kit	Insulation for Accumulator		High Static Fan Motor		
MAC-890 SG-E	MAC-881 SG	MAC-882 SG	MAC-856 SG	MAC-886 SG-E	MAC-883 SG	PAC-SJ07 SG-E	PAC-SG59 SG-E	PAC-SH96 SG-E	PAC-SJ06 AG-E	PAC-SH63 AG-E	PAC-SH95 AG-E	PAC-SJ08 DS-E	PAC-SG60 DS-E	PAC-SG61 DS-E	MAC-643 BH-E	MAC-644 BH-E	MAC-646 BH-E	PAC-SG63 DP-E	PAC-SG64 DP-E	PAC-SH97 DP-E	PAC-IF01 MNT-E	PAC-SJ96 MA-E	PAC-SJ95 MA-E	PAC-SK52ST	PAC-IF012 B-E	MAC-892 INS-E	MAC-893 INS-E	PAC-SJ71 FM-E		





# External Dimensions

**M SERIES**

Unit: mm

**MUZ-RW25VGHZ MUZ-RW35VGHZ MUZ-RW50VGHZ**

**INDOOR UNIT**

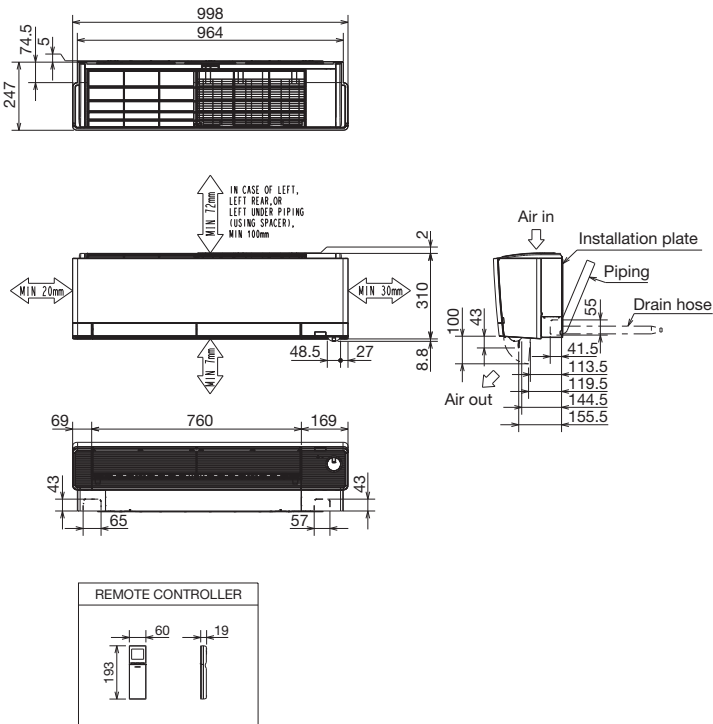

**MSZ-LN25VG2(W)(V)(R)(B) MSZ-LN35VG2(W)(V)(R)(B)  
MSZ-LN50VG2(W)(V)(R)(B) MSZ-LN60VG2(W)(V)(R)(B)**

**INDOOR UNIT**

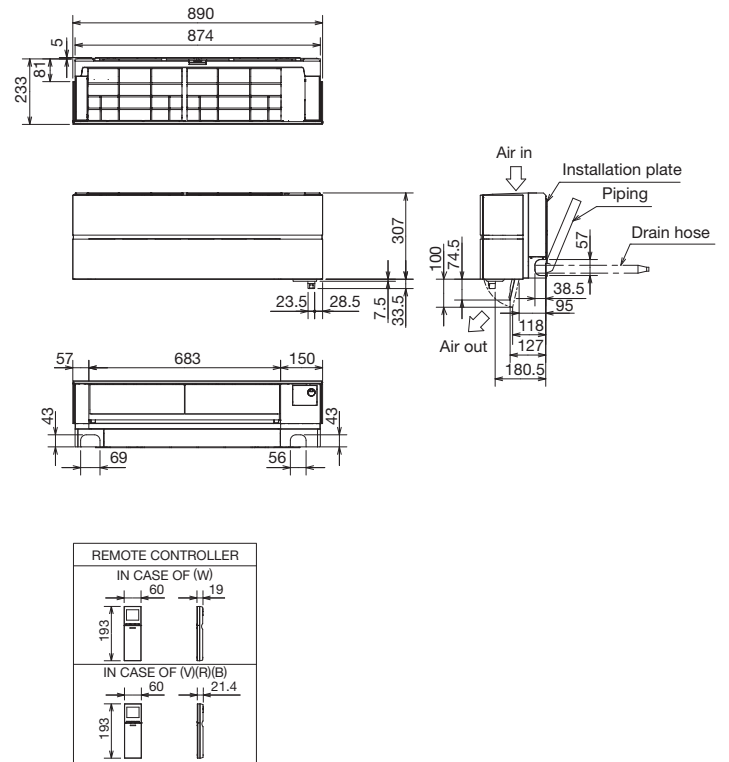

**MSZ-FT25VG MSZ-FT35VG MSZ-FT50VG  
MSZ-FT25VGK MSZ-FT35VGK MSZ-FT50VGK**

**INDOOR UNIT**

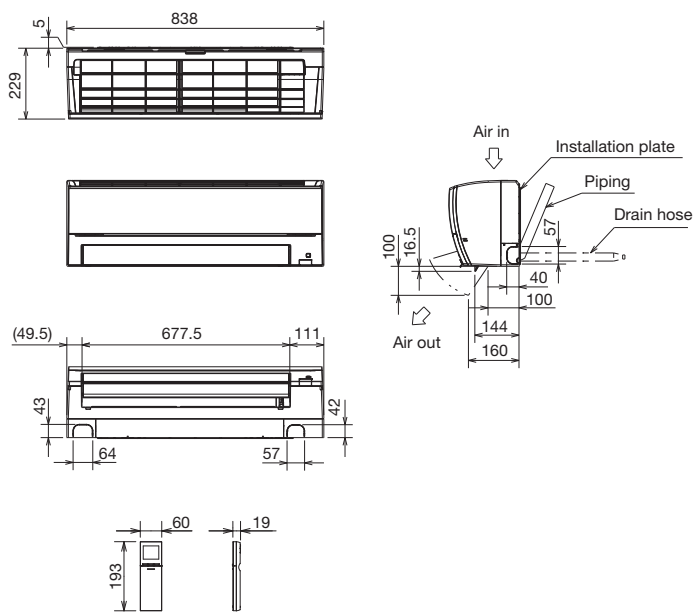

**MSZ-AY15VGK(P) MSZ-AY20VGK(P)**

**INDOOR UNIT**

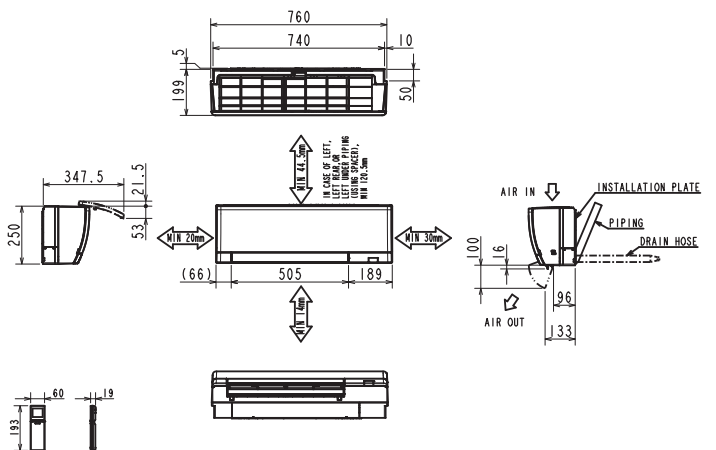

**MSZ-AY25VGK(P) MSZ-AY35VGK(P) MSZ-AY42VGK(P)**  
**MSZ-AY50VGK(P)**

**INDOOR UNIT**

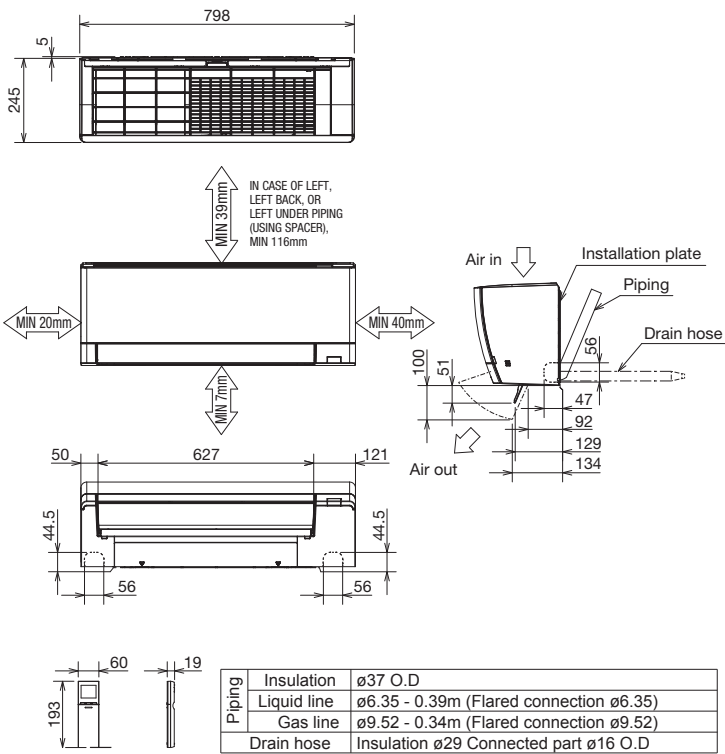

**MSZ-AP60VG MSZ-AP71VG**  
**MSZ-AP60VGK MSZ-AP71VGK**

**INDOOR UNIT**

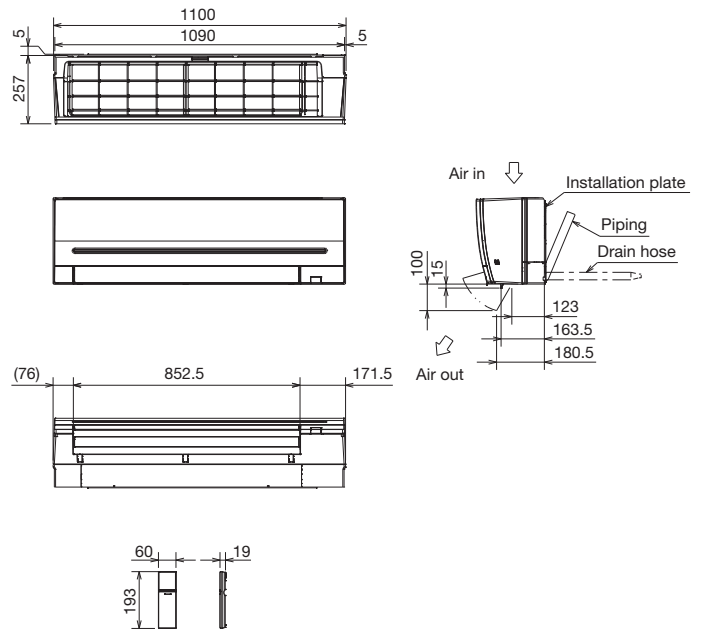

**MSZ-EF18VG(W)(B)(S) MSZ-EF22VG(W)(B)(S)**  
**MSZ-EF25VG(W)(B)(S) MSZ-EF35VG(W)(B)(S)**  
**MSZ-EF42VG(W)(B)(S) MSZ-EF50VG(W)(B)(S)**  
**MSZ-EF18VGK(W)(B)(S) MSZ-EF22VGK(W)(B)(S)**  
**MSZ-EF25VGK(W)(B)(S) MSZ-EF35VGK(W)(B)(S)**  
**MSZ-EF42VGK(W)(B)(S) MSZ-EF50VGK(W)(B)(S)**

**INDOOR UNIT**

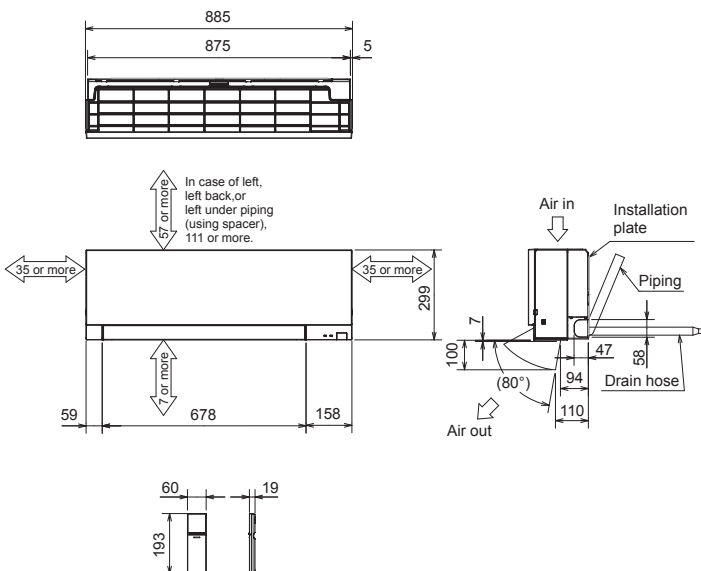

**MSZ-BT20VG MSZ-BT25VG MSZ-BT35VG MSZ-BT50VG**  
**MSZ-BT20VGK MSZ-BT25VGK MSZ-BT35VGK MSZ-BT50VGK**

**INDOOR UNIT**

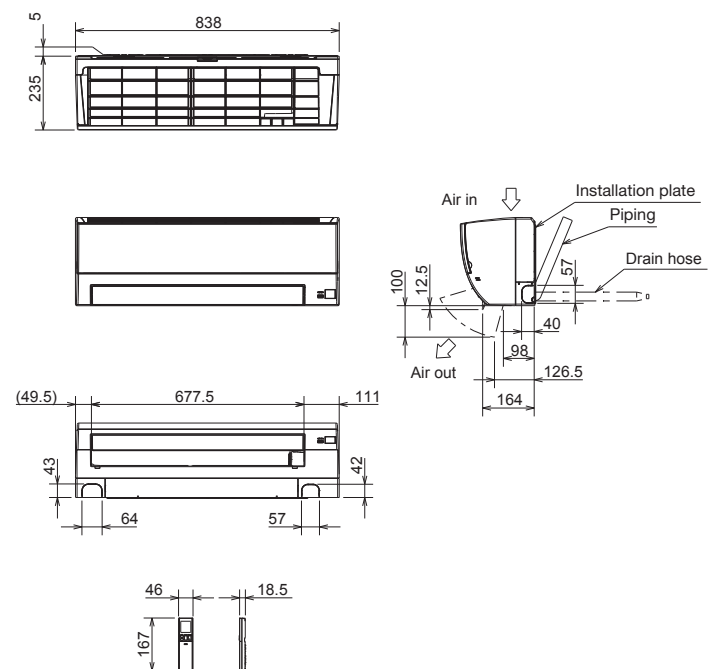

**MSZ-HR25VF(K) MSZ-HR35VF(K) MSZ-HR42VF(K)  
MSZ-HR50VF(K)**

**INDOOR UNIT**

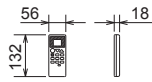
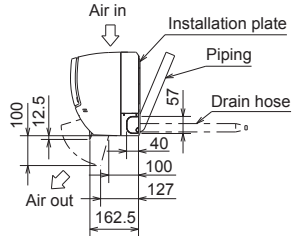
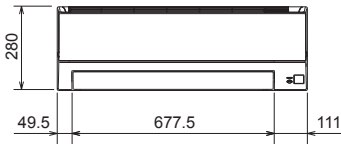
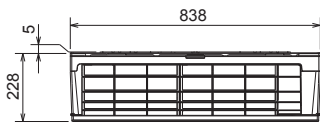

**MSZ-HR60VF(K) MSZ-HR71VF(K)**

**INDOOR UNIT**

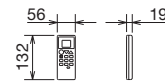
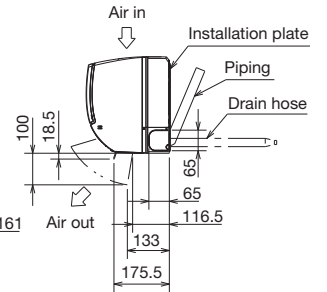
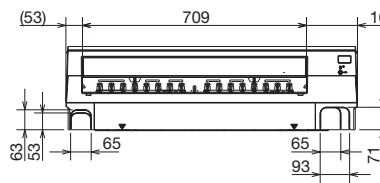
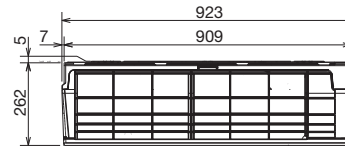

**MSZ-DW25VF MSZ-DW35VF MSZ-DW50VF**

**INDOOR UNIT**

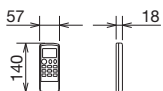
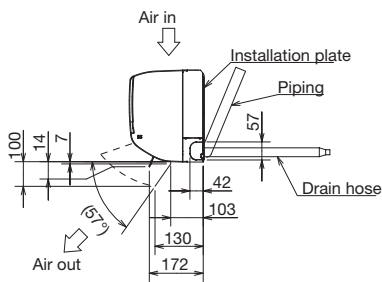
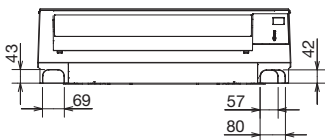
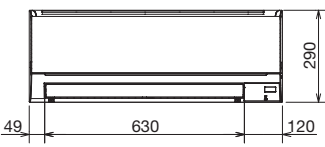
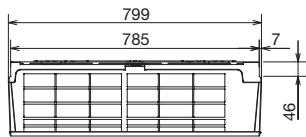

**MSZ-FH25VE2 MSZ-FH35VE2 MSZ-FH50VE2**

**INDOOR UNIT**

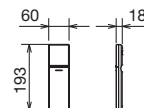
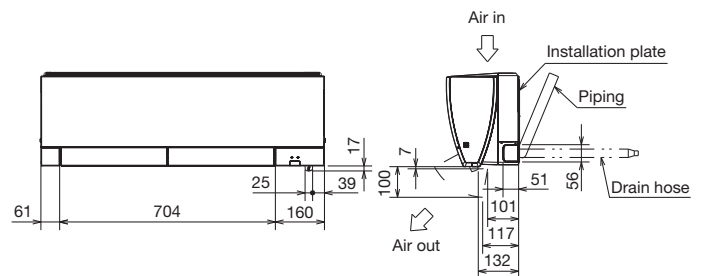
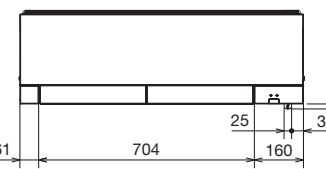
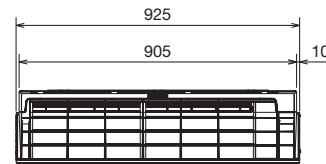



**MSZ-SF15VA MSZ-SF20VA**

**INDOOR UNIT**

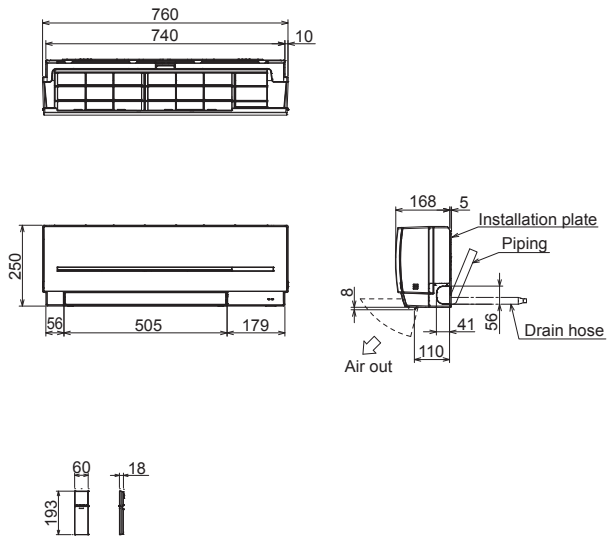

**MSZ-SF25VE3 MSZ-SF35VE3 MSZ-SF42VE3  
MSZ-SF50VE3**

**INDOOR UNIT**

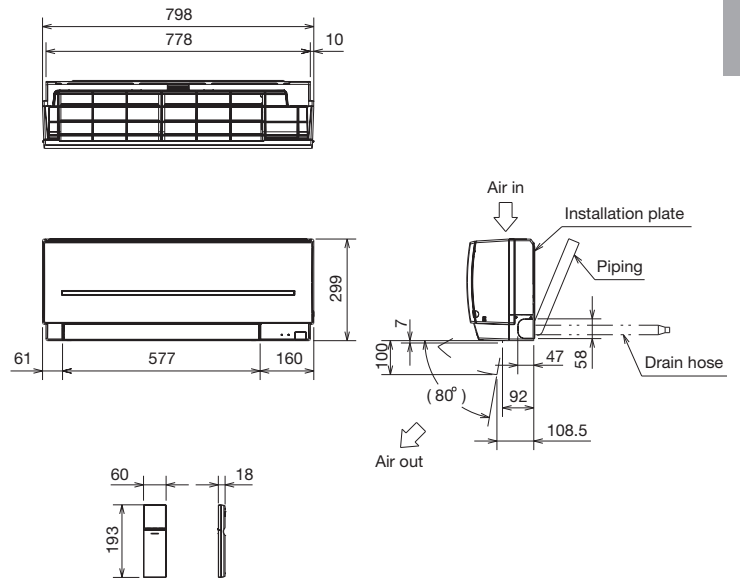

**MSZ-GF60VE2 MSZ-GF71VE2**

**INDOOR UNIT**

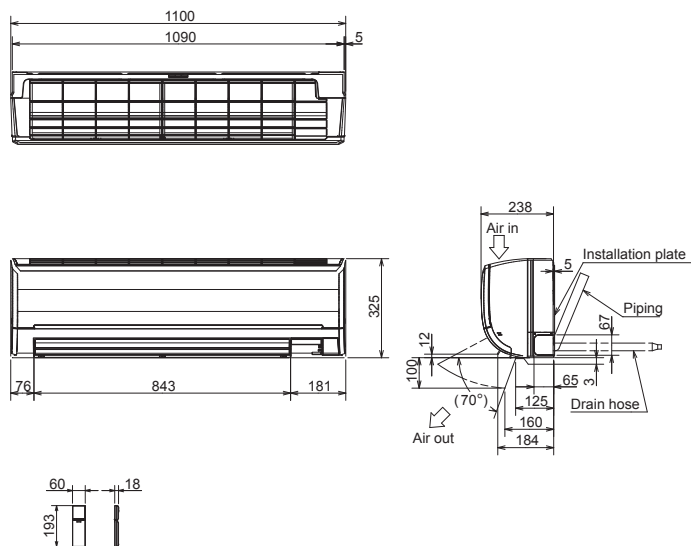

**MSZ-WN25VA MSZ-WN35VA**

**INDOOR UNIT**

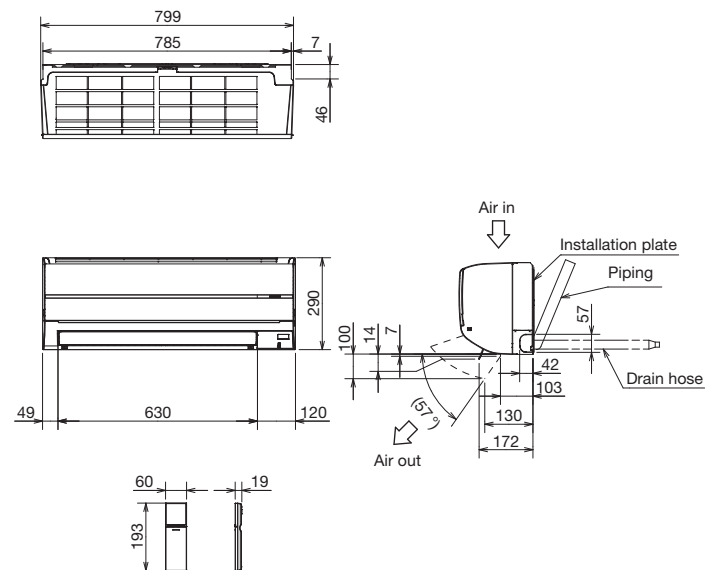

**MSZ-DM25VA MSZ-DM35VA**

**INDOOR UNIT**

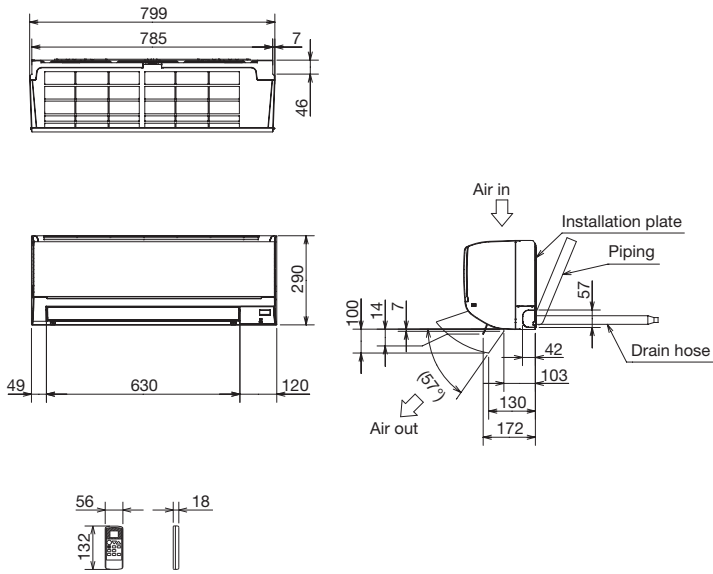

**MSZ-HJ25VA MSZ-HJ35VA MSZ-HJ50VA**

**INDOOR UNIT**

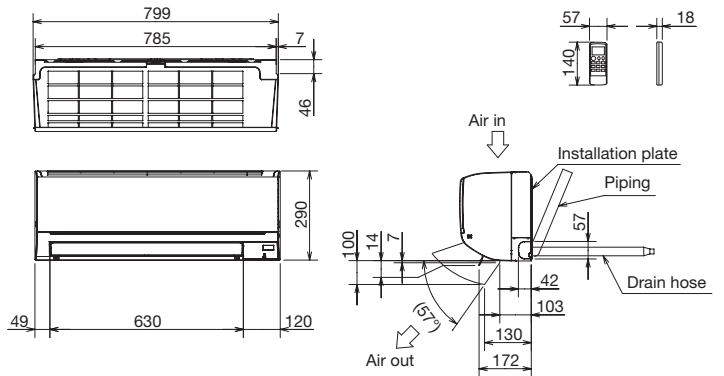

**MSZ-HJ60VA MSZ-HJ71VA  
MSY-TP35VF MSY-TP50VF**

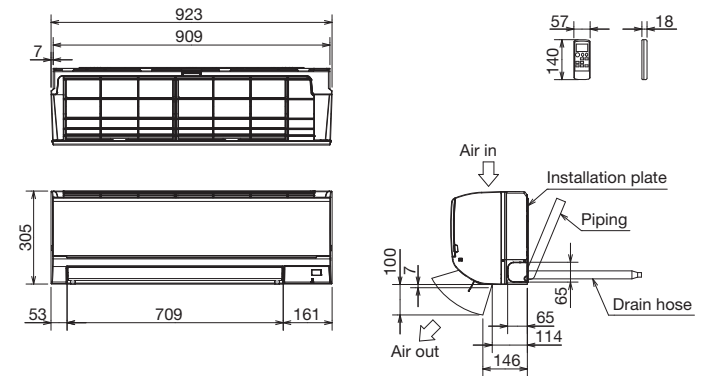

**MFZ-KT25VG MFZ-KT35VG MFZ-KT50VG MFZ-KT60VG**

**INDOOR UNIT**

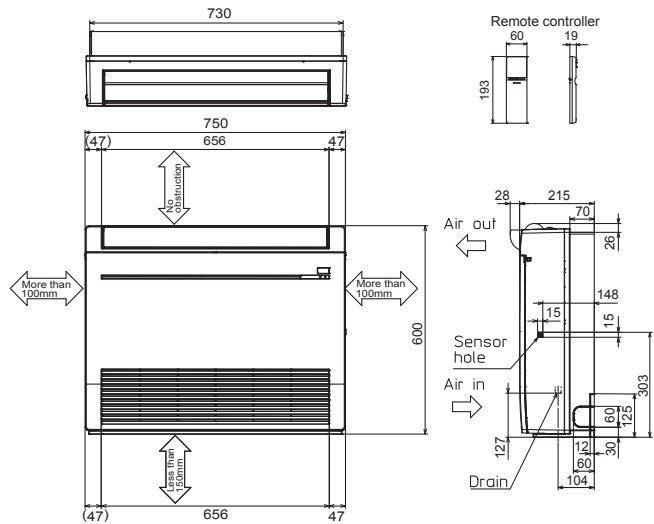

**MFZ-KW25VG MFZ-KW35VG MFZ-KW50VG MFZ-KW60VG**

**INDOOR UNIT**

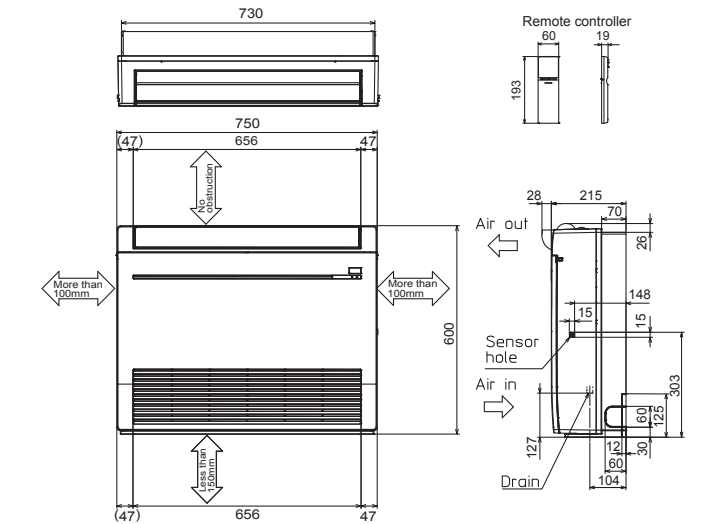

**MLZ-KP25VF MLZ-KP35VF MLZ-KP50VF**

**INDOOR UNIT**

**INDOOR UNIT OUTLINE DRAWING**

(TOP VIEW)

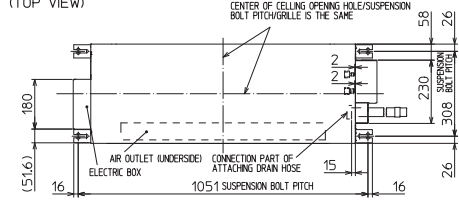

(FRONT VIEW)

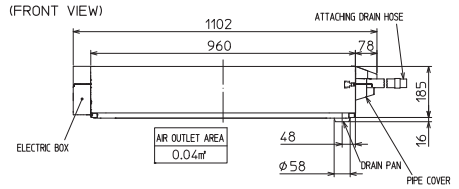

**REMOTE CONTROLLER OUTLINE DRAWING**

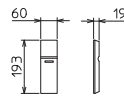

(RIGHT SIDE VIEW)

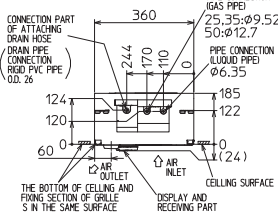

**INDOOR UNIT DETAIL VIEW**

(TOP VIEW)

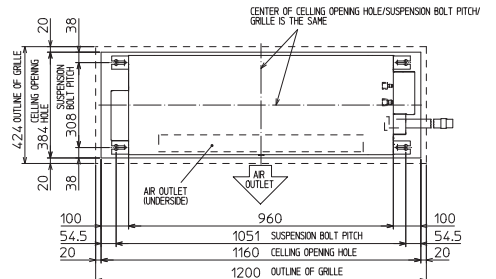

(FRONT VIEW)

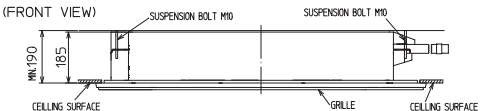

**GRILLE OUTLINE DRAWING**

(MLP-444W)

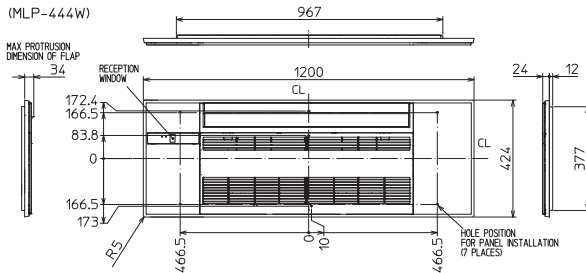

	KP25/35VF	KP50VF
EXTENSION PIPE	LIQUID PIPE O.D. $\phi 6.35$	
	GAS PIPE O.D. $\phi 9.52$	$\phi 12.7$
CONNECTIONS OF PIPE	FLARED CONNECTION $\phi 6.35$	
	LIQUID PIPE	FLARED CONNECTION $\phi 12.7$
	GAS PIPE	FLARED CONNECTION $\phi 9.52$
DRAIN HOSE	HEAT INSULATOR O.D. CONNECTION I.D. EFFECTIVE LENGTH $\phi 32$ $\phi 25$ 480	
DRAIN PIPE CONNECTION	RIGID PVC PIPE O.D. $\phi 26$	

NOTE1. CUTTING ATTACHING DRAIN HOSE CAN BE USED.

THE METHOD FOR STANDING DRAIN FROM INDOOR UNIT  
\* CUTTING ATTACHING DRAIN HOSE CAN BE USED

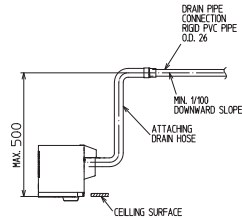

**MLZ-KY20VG**

**INDOOR UNIT**

**INDOOR UNIT OUTLINE DRAWING**

(TOP VIEW)

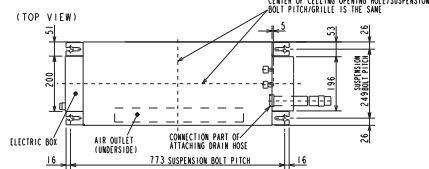

(FRONT VIEW)

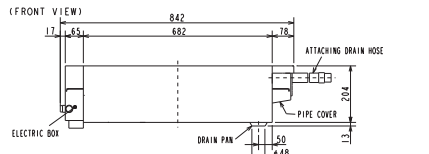

**REMOTE CONTROLLER OUTLINE DRAWING**

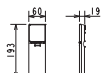

(RIGHT SIDE VIEW)

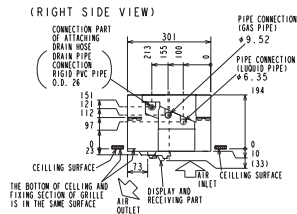

**INDOOR UNIT DETAIL VIEW**

(TOP VIEW)

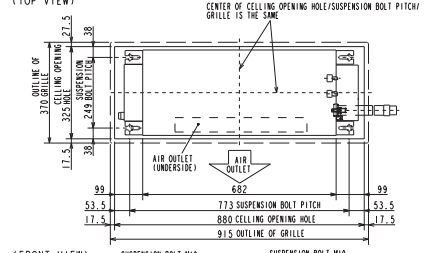

(FRONT VIEW)

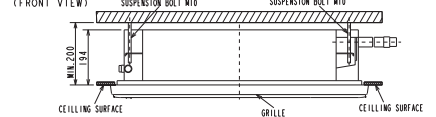

**GRILLE OUTLINE DRAWING**

(MLP-448W)

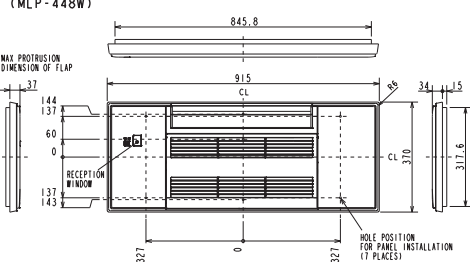

	KP25/35VF	KP50VF
EXTENSION PIPE	LIQUID PIPE O.D. $\phi 6.35$	
	GAS PIPE O.D. $\phi 9.52$	$\phi 12.7$
CONNECTIONS OF PIPE	FLARED CONNECTION $\phi 6.35$	
	LIQUID PIPE	FLARED CONNECTION $\phi 12.7$
	GAS PIPE	FLARED CONNECTION $\phi 9.52$
DRAIN HOSE	HEAT INSULATOR O.D. CONNECTION I.D. EFFECTIVE LENGTH $\phi 32$ $\phi 25$ 480	
DRAIN PIPE CONNECTION	RIGID PVC PIPE O.D. $\phi 26$	

NOTE1. CUT THE DRAIN HOSE (ACCESSORY) FOR USE, IF NECESSARY.

THE METHOD FOR STANDING DRAIN FROM INDOOR UNIT  
\* CUT THE DRAIN HOSE (ACCESSORY) FOR USE, IF NECESSARY.

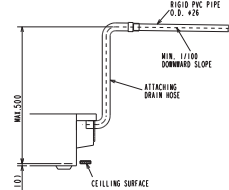

MUZ-LN25VG MUZ-LN25VGHZ  
 MUZ-LN35VG MUZ-LN35VGHZ  
 MUZ-AY20VG MUZ-AY25VGH  
 MUZ-AY25VG MUZ-AY35VGH  
 MUZ-AY35VG MUZ-AY42VGH  
 MUZ-FT25VGHZ MUZ-FH35VE  
 MUZ-FH25VE MUZ-FH35VEHZ  
 MUZ-FH25VEHZ MUZ-EF25VGH  
 MUZ-EF25VG MUZ-EF35VGH  
 MUZ-EF35VG MUZ-Y-TP35VF  
 MUZ-EF42VG MUZ-SF25VEH  
 MUZ-SF25VE MUZ-SF42VE  
 MUZ-SF35VEH MUZ-FZ-KJ35VE  
 MUZ-HJ50VA MUFZ-KJ35VEHZ  
 MUFZ-KJ25VE MUFZ-KJ35VEHZ

MUZ-HR42VF  
 MUZ-HR50VF  
 MUZ-DW50VF  
 MUY-TP50VF  
 MUZ-SF35VE  
 MUZ-SF42VEH  
 MUZ-BT50VG

**OUTDOOR UNIT**

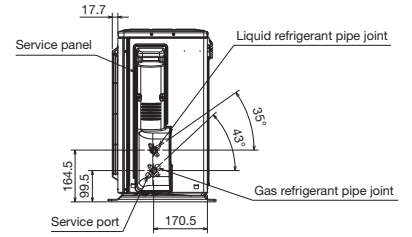
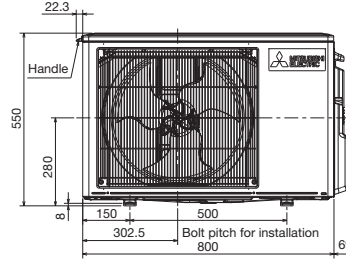
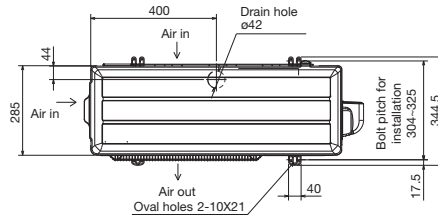

MUZ-FH50VE MUZ-FH50VEHZ MUZ-AP71VG  
 MUZ-SF50VE MUZ-SF50VEH  
 MUZ-GF60VE MUZ-GF71VE  
 MUZ-HJ60VA MUZ-HJ71VA  
 MUFZ-KJ50VE MUFZ-KJ50VEHZ

MUZ-AY15VG MUZ-BT20VG

**OUTDOOR UNIT**

**OUTDOOR UNIT**

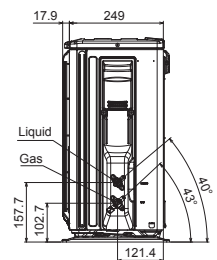
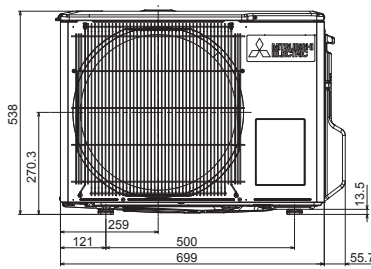
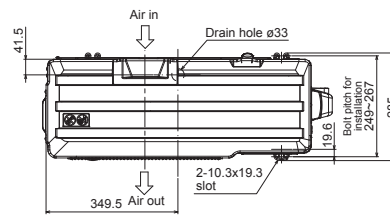
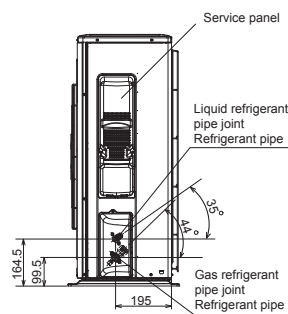
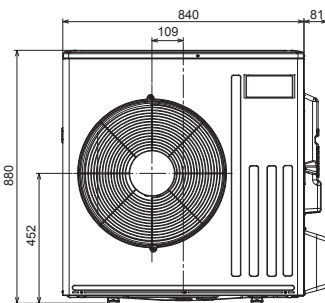
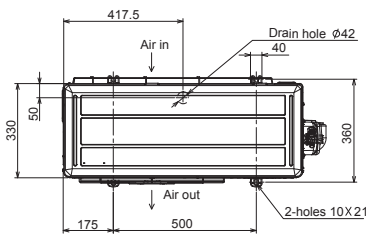

**MUZ-WN25VA MUZ-WN35VA MUZ-HR25VF MUZ-BT25VG**  
**MUZ-DM25VA MUZ-DM35VA MUZ-HR35VF MUZ-BT35VG**  
**MUZ-HJ25VA MUZ-HJ35VA**  
**MUZ-DW25VF MUZ-DW35VF**

**OUTDOOR UNIT**

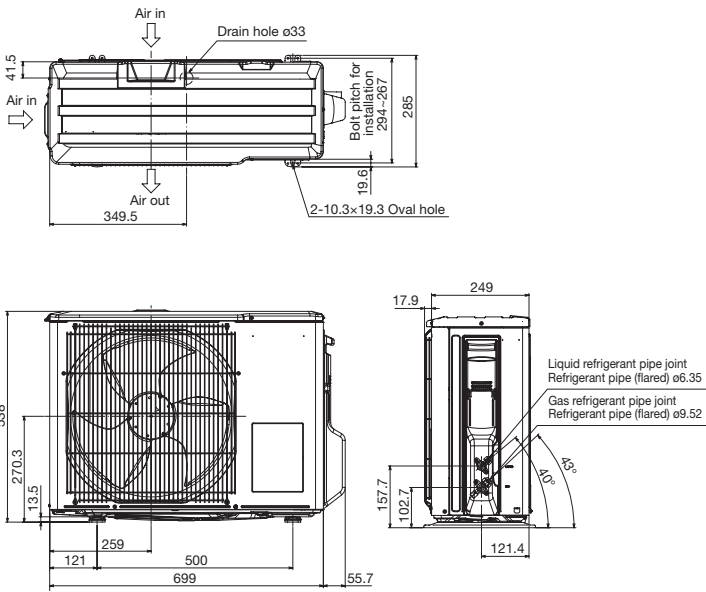

**MUZ-RW25VGHZ MUZ-RW35VGHZ**  
**MUZ-LN50VG**  
**MUZ-FT35/50VGHZ**  
**MUZ-AY50VG MUZ-AY50VGH MUZ-AP60VG**  
**MUZ-EF50VG**  
**MUZ-HR60VF MUZ-HR71VF**

**OUTDOOR UNIT**

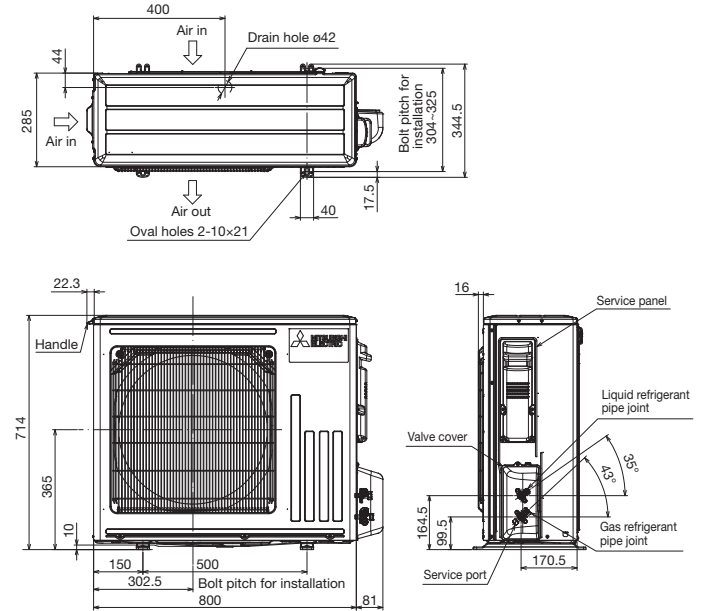

**MUZ-RW50VGHZ**  
**MUZ-LN60VG2**  
**MUZ-LN50VGHZ2**

**OUTDOOR UNIT**

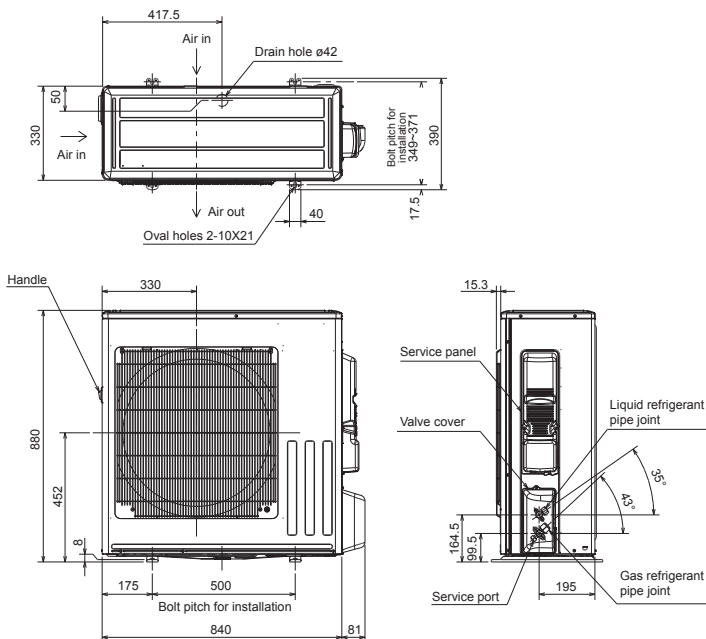

**SLZ-M15FA2  
SLZ-M25FA2 SLZ-M35FA2  
SLZ-M50FA2 SLZ-M60FA2**

**INDOOR UNIT**

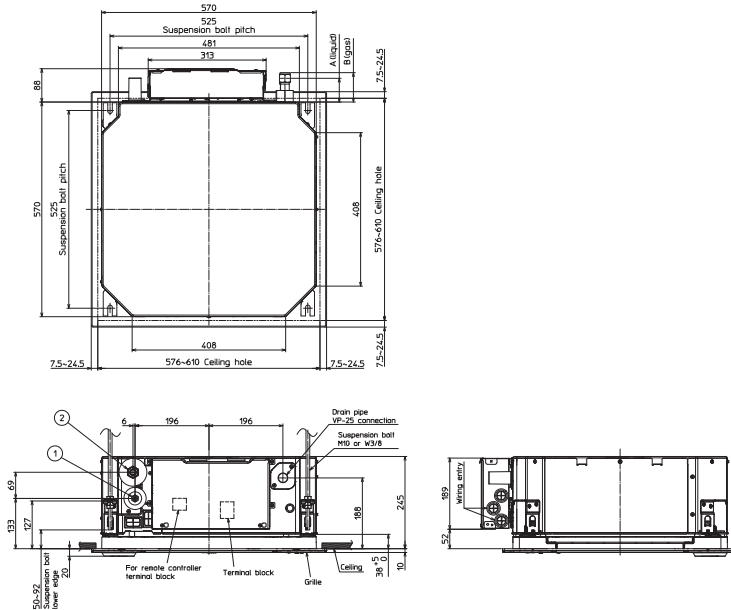

Models	① Refrigerant pipe (liquid)	② Refrigerant pipe (gas)	A	B
SLZ-M15FA2 SLZ-M25FA2 SLZ-M35FA2	φ6.35mm flared connection 1/4F	φ9.52mm flared connection 3/8F	63mm	72mm
SLZ-M50FA2	φ6.35mm flared connection 1/4F	φ12.7mm flared connection 1/2F	63mm	78mm
SLZ-M60FA2	φ6.35mm flared connection 1/4F	φ15.88mm flared connection 5/8F	63mm	78mm

**SEZ-M25DA(L)2 SEZ-M35DA(L)2 SEZ-M50DA(L)2  
SEZ-M60DA(L)2 SEZ-M71DA(L)2**

**INDOOR UNIT**

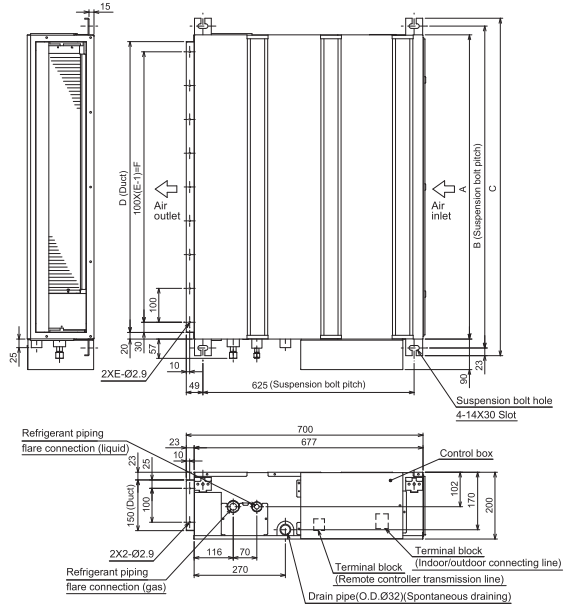

**SFZ-M25VA SFZ-M35VA  
SFZ-M60VA SFZ-M71VA**

**INDOOR UNIT**

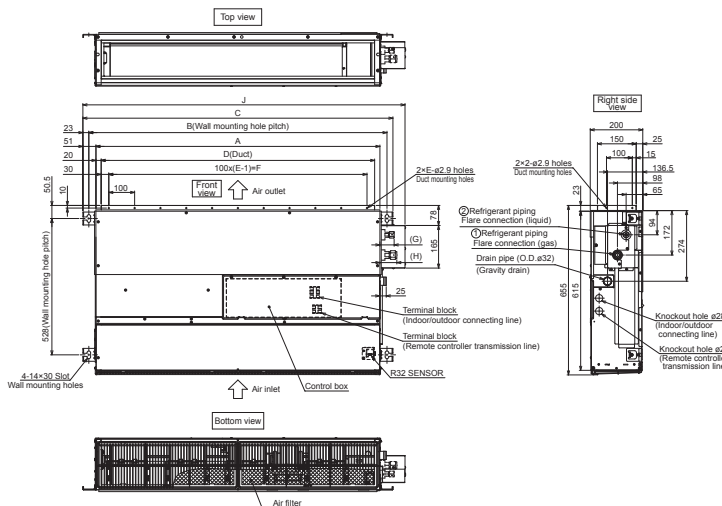

MODEL	A	B	C	D	E	F	G	H	J	① Gas pipe	② Liquid pipe
SFZ-M25VA	700	756	802	660	7	600	50	55	848	ø9.52	ø6.35
SFZ-M35VA	900	956	1002	860	9	800	50	55	1048	ø9.52	ø6.35
SFZ-M50VA	900	956	1002	860	9	800	50	61	1048	ø12.7	ø6.35
SFZ-M60VA	1100	1156	1202	1060	11	1000	50	66	1248	ø15.88	ø6.35
SFZ-M71VA	1100	1156	1202	1060	11	1000	55	66	1248	ø15.88	ø9.52

**SUZ-M25VA SUZ-M35VA**

**OUTDOOR UNIT**

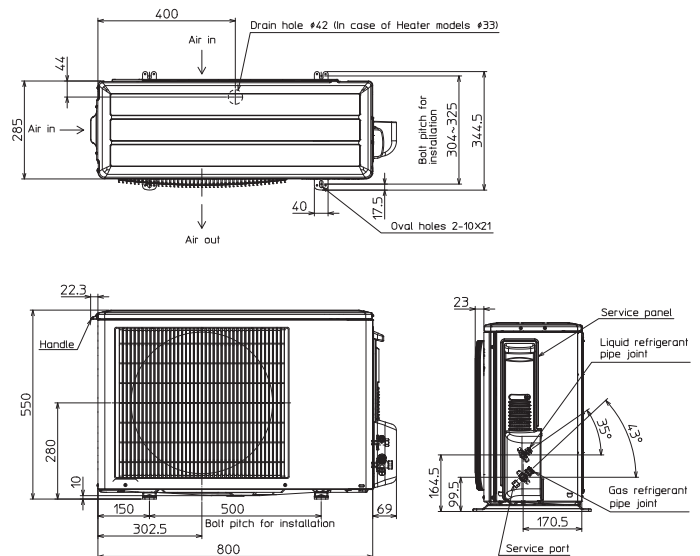

**SUZ-M50VA**

**OUTDOOR UNIT**

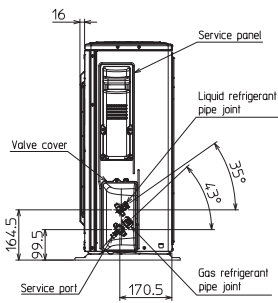
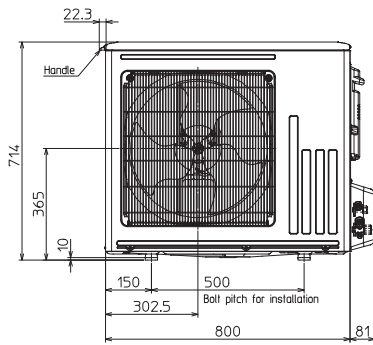
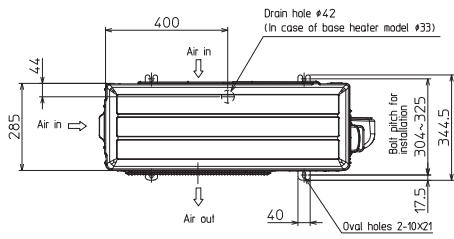

**SUZ-M60VA SUZ-M71VA**

**OUTDOOR UNIT**

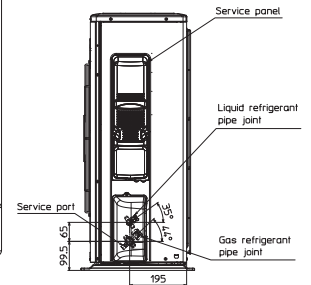
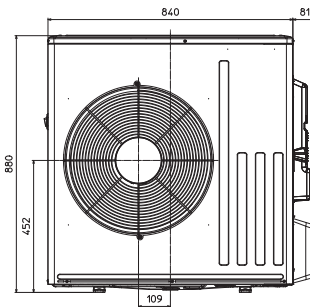
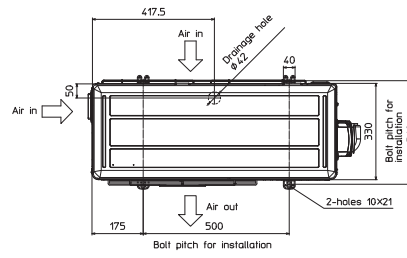

PLA-ZM35EA2 PLA-ZM50EA2 PLA-ZM60EA2 PLA-ZM71EA2  
 PLA-ZM100EA2 PLA-ZM125EA2 PLA-ZM140EA2  
 PLA-M35EA2 PLA-M50EA2 PLA-M60EA2 PLA-M71EA2  
 PLA-M100EA2 PLA-M125EA2 PLA-M140EA2

INDOOR UNIT

ZM	①	②	A	B	C	D	E	F
35/50	REFRIGERANT PIPE #6.35 FLARED CONNECTION 5/8"	REFRIGERANT PIPE #12.7 FLARED CONNECTION 1/2"	241	258	76	76.5	265 OR MORE	3500 OR LESS
60	REFRIGERANT PIPE #6.35 FLARED CONNECTION 5/8"	REFRIGERANT PIPE #12.7 FLARED CONNECTION 1/2"			79.5	79.5		
71			281	298			305 OR MORE	4000 OR LESS
100-140								

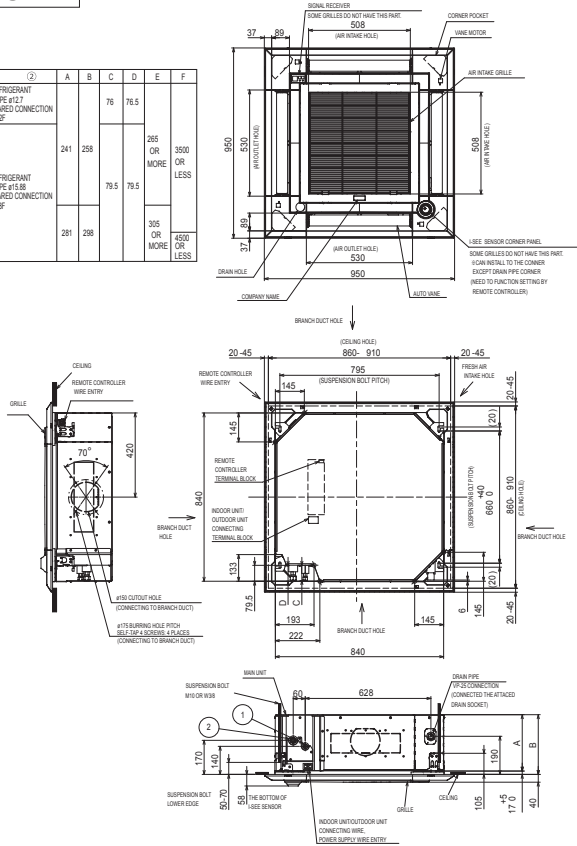

PKA-M35LA(L)2 PKA-M50LA(L)2

INDOOR UNIT

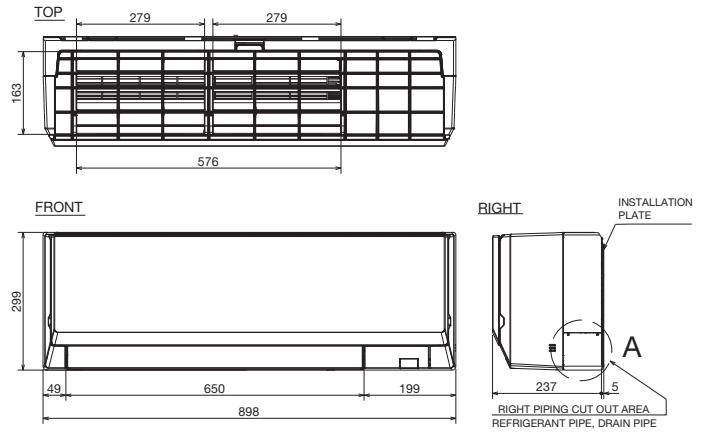

PKA-M60KA(L)2 PKA-M71KA(L)2 PKA-M100KA(L)2

INDOOR UNIT

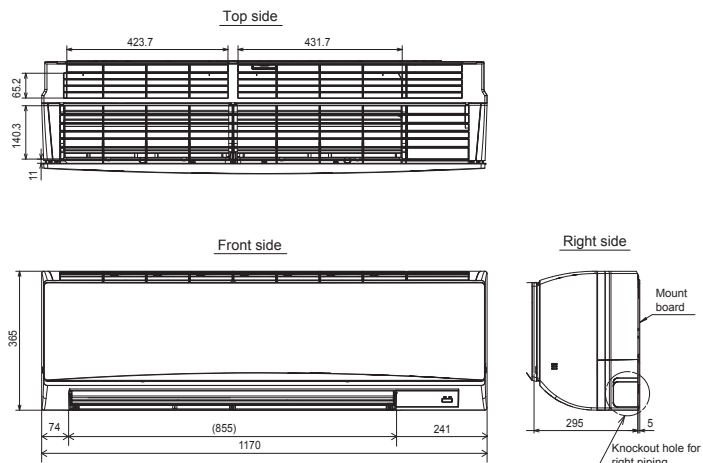

PCA-M35KA2 PCA-M50KA2

INDOOR UNIT

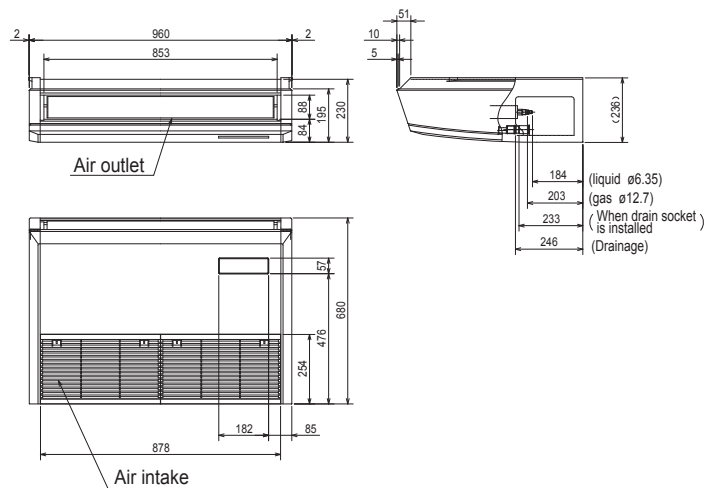

- NOTES.
1. Use M10 or W3/8 screw for anchor bolt.
  2. Please be sure when installing the drain pump (option parts), refrigerant pipe will be only upward.









**PUZ-M100VKA2 PUZ-M100YKA2  
PUZ-M125VKA2 PUZ-M125YKA2  
PUZ-M140VKA2 PUZ-M140YKA2**

**OUTDOOR UNIT**

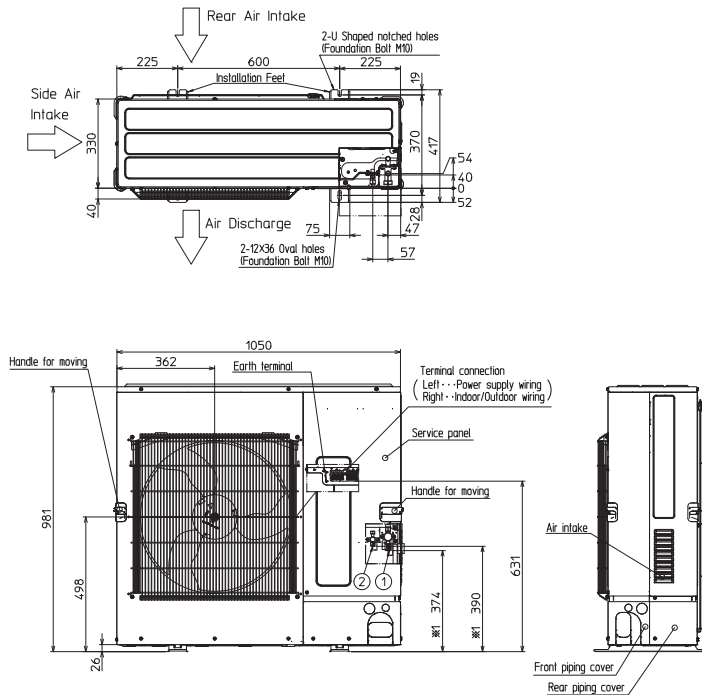

**Example Of Notes**

- ①...Refrigerant GAS pipe connection (FLARE) Ø15.88 (1/8F)
- ②...Refrigerant LIQUID pipe connection (FLARE) Ø9.52 (3/8F)
- ※1...Indication of STOP VALVE connection location.

**PUZ-M200YKA2 PUZ-M250YKA2**

**OUTDOOR UNIT**

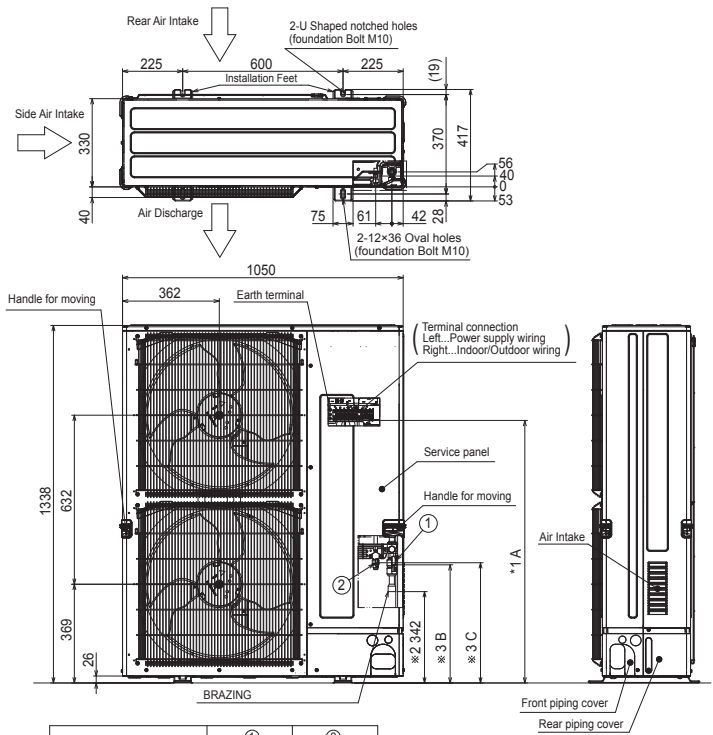

Model	① Refrigerant GAS pipe connection	② Refrigerant LIQUID pipe connection
PUZ-ZM/M200YKA.UK	ø19.05 (3/4F)	ø9.52 (3/8F)
PUZ-ZM/M250YKA.UK	ø19.05 (3/4F)	ø12.7 (1/2F)

Model	A	B	C	
PUZ-ZM/M200,250YKA.UK	985	442	450	※ 1...Indication of Terminal connection location. ※ 2...Refrigerant GAS PIPE connection (BRAZING) O.D.ø25.4. ※ 3...Indication of STOP VALVE connection location.





PUMY-P112/125/140VKM6(-BS)

PUMY-P112/125/140YKM5(-BS)

OUTDOOR UNIT

OUTDOOR UNIT

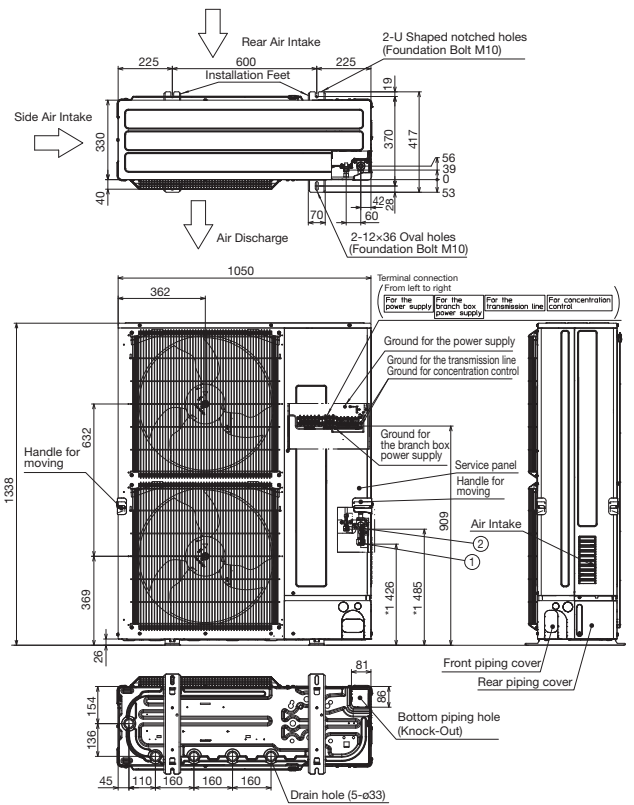
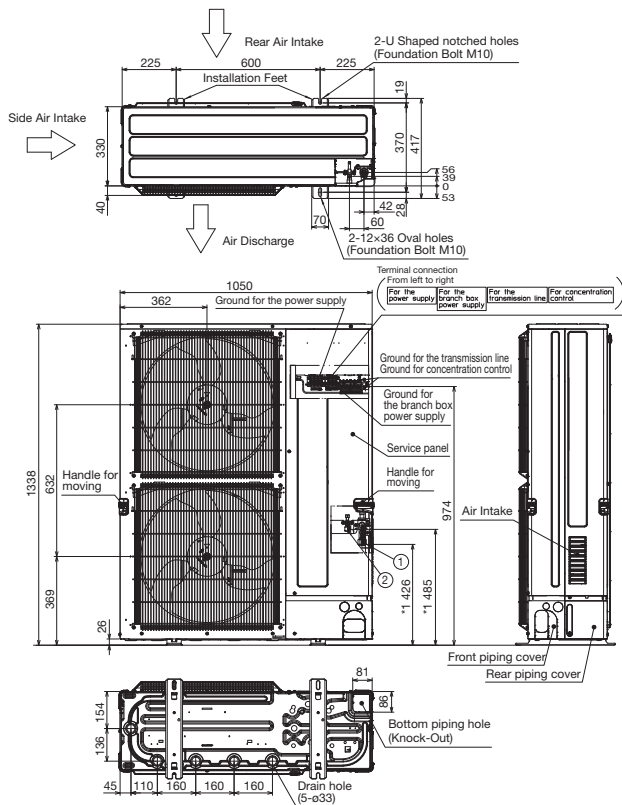

Example of Notes

- ① --Refrigerant GAS pipe connection (FLARE) ø15.88 (5/8F)
- ② --Refrigerant LIQUID pipe connection (FLARE) ø9.52 (3/8F)
- \*1 --Indication of STOP VALVE connection location.

Example of Notes

- ① --Refrigerant GAS pipe connection (FLARE) ø15.88 (5/8F)
- ② --Refrigerant LIQUID pipe connection (FLARE) ø9.52 (3/8F)
- \*1 --Indication of STOP VALVE connection location.

PUMY-P200YKM3(-BS)

PUMY-SP112/125/140VKM2(-BS)  
PUMY-SP112/125/140YKM2(-BS)

OUTDOOR UNIT

OUTDOOR UNIT

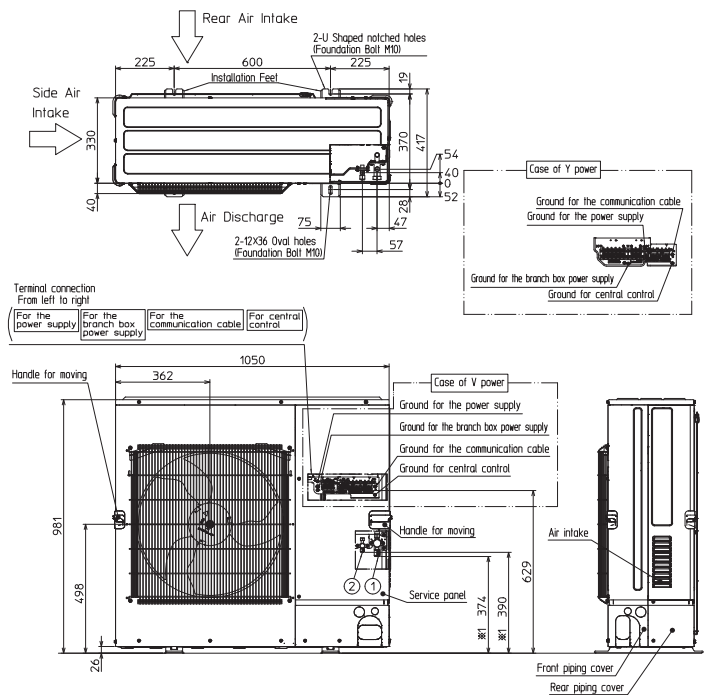
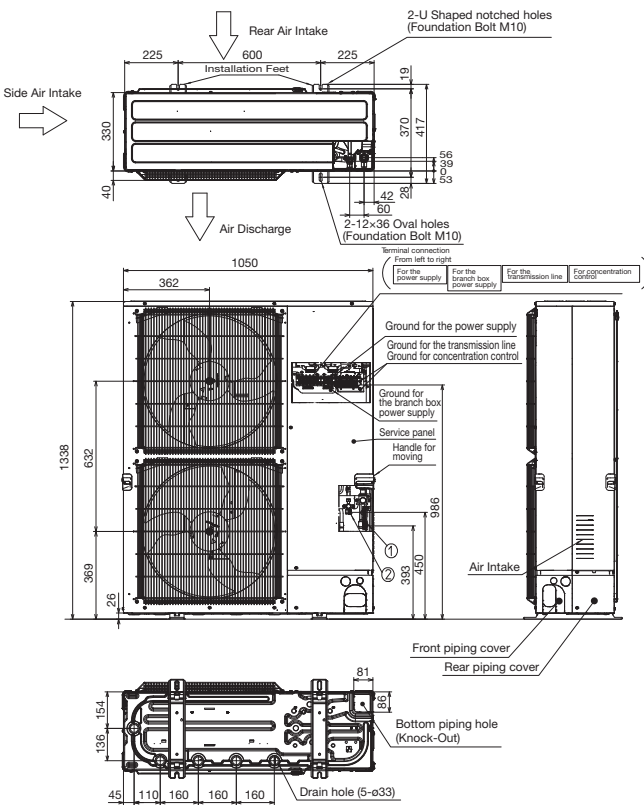

Example of Notes

- ① --Refrigerant GAS pipe connection (FLARE) ø19.05 (3/4F)
- ② --Refrigerant LIQUID pipe connection (FLARE) ø9.52 (3/8F)
- \*1 --Indication of STOP VALVE connection location.

Example of Notes

- ① --Refrigerant GAS pipe connection (FLARE) ø15.88 (5/8F)
- ② --Refrigerant LIQUID pipe connection (FLARE) ø9.52 (3/8F)
- \*1 --Indication of STOP VALVE connection location.

### PAC-MK54BC

Suspension bolt: W3/W8 (M10)

#### Branch box

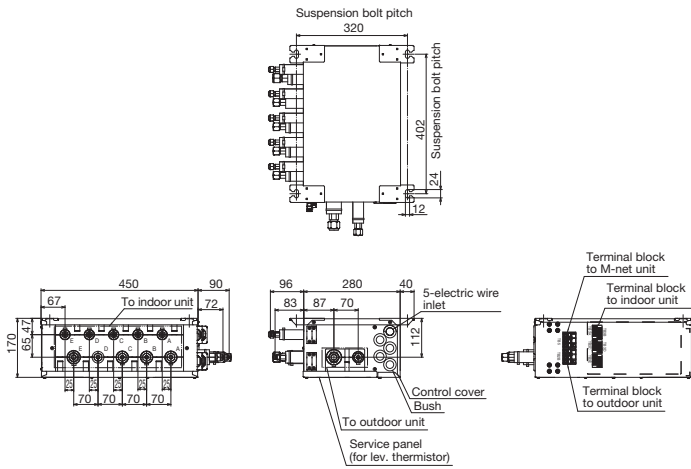

Suspension bolt : W3/8(M10)  
Refrigerant pipe flared connection

	A	B	C	D	E	To outdoor unit
Liquid pipe	ø6.35	ø6.35	ø6.35	ø6.35	ø6.35	ø9.52
Gas pipe	ø9.52	ø9.52	ø9.52	ø9.52	ø12.7	ø15.88

### PAC-MK34BC

Suspension bolt: W3/W8 (M10)

#### Branch box

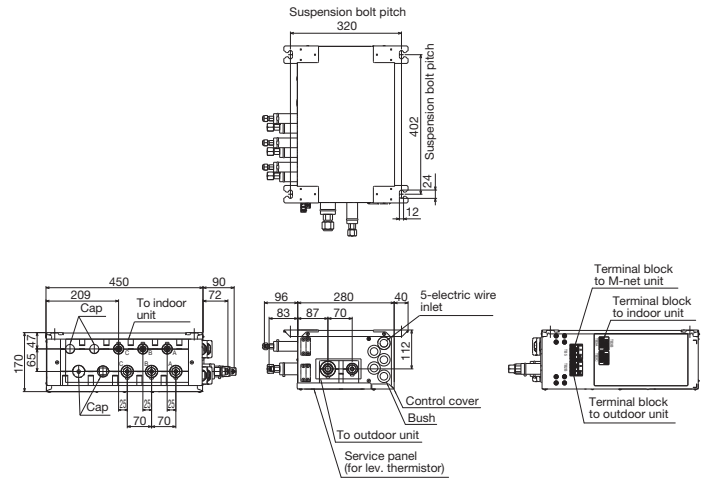

Suspension bolt : W3/8(M10)  
Refrigerant pipe flared connection

	A	B	C		To outdoor unit
Liquid pipe	ø6.35	ø6.35	ø6.35		ø9.52
Gas pipe	ø9.52	ø9.52	ø9.52		ø15.88

### PUMY-P250YBM2(-BS) PUMY-P300YBM2(-BS)

#### OUTDOOR UNIT

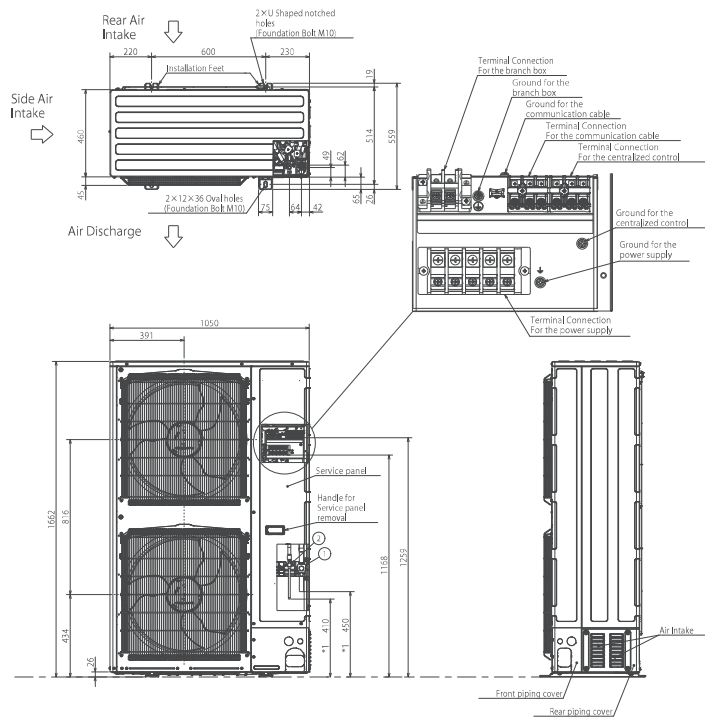

#### Example of Notes

- . . . Refrigerant GAS pipe connection Φ22.2(7/8F)
- . . . Refrigerant LIQUID pipe connection Φ9.52(3/8F)
- \*1 . . . Indication of STOP VALVE and BALL VALVE connection location.



### PAC-MMK40BCB

Suspension bolt: W3/W8 (M10)

#### Branch box

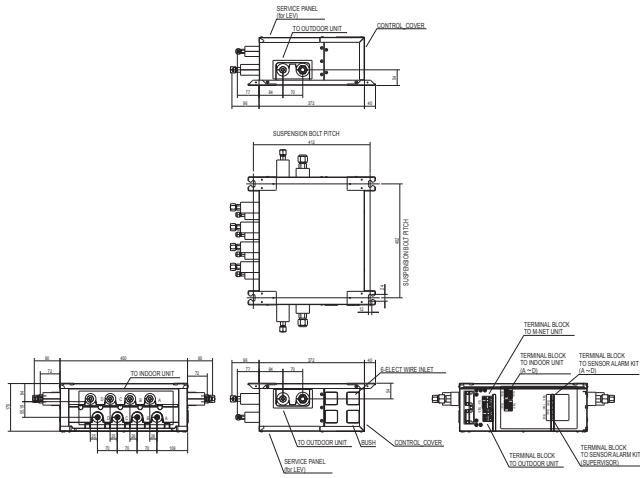

SUSPENSION BOLT W3/W8(M10)  
REFRIGERANT PIPE FLARED CONNECTION

	A	B	C	D	TO INDOOR UNIT	TO OUTDOOR UNIT
LIQUID PIPE	φ6.35	φ6.35	φ6.35	φ6.35	φ6.35	φ6.35
GAS PIPE	φ12.7	φ12.7	φ12.7	φ12.7	φ12.7	φ12.7

### PAC-MMK60BCB

Suspension bolt: W3/W8 (M10)

#### Branch box

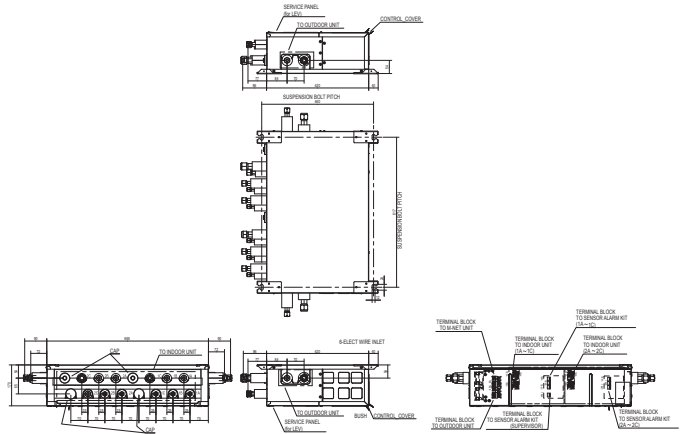

SUSPENSION BOLT W3/W8(M10)  
REFRIGERANT PIPE FLARED CONNECTION

	1A	1B	1C	2A	2B	2C	TO INDOOR UNIT	TO OUTDOOR UNIT
LIQUID PIPE	φ6.35	φ6.35	φ6.35	φ6.35	φ6.35	φ6.35	φ6.35	φ6.35
GAS PIPE	φ12.7	φ12.7	φ12.7	φ12.7	φ12.7	φ12.7	φ12.7	φ12.7

### PUMY-SM112V(Y)KM(-BS) PUMY-SM125V(Y)KM(-BS) PUMY-SM140V(Y)KM(-BS)

#### OUTDOOR UNIT

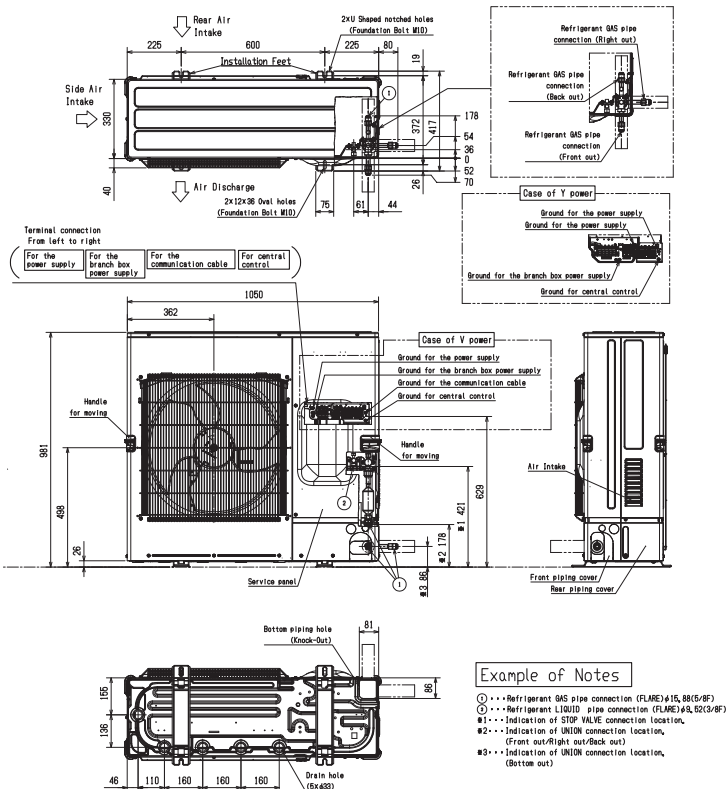

# Piping Installation

## M SERIES

### Single type

Series	Class < Outdoor unit >	Maximum Piping Length (m)		Maximum Height Difference (m)		Maximum Number of Bends	
		Total length (A)	Indoor unit - Distribution pipe B	Outdoor unit - Indoor unit (H)	Indoor unit - Indoor unit h	Total number	Total number
MSZ-RW	25 / 35	20		12		10	
	50	30		15		10	
MSZ-L	25 / 35	20		12		10	
	50	20		12		10	
	60	30		15		10	
MSZ-FT	25	20		12		10	
	35 / 50	30		15		10	
MSZ-A	15 / 20 / 25 / 35 / 42 / 50	20		12		10	
	60 / 71	30		15		10	
MSZ-EF	25 / 35 / 42	20		12		10	
	50	30		15		10	
MSZ-BT	20 / 25 / 35 / 50	20		12		10	
MSZ-HR	25 / 35 / 42 / 50	20		12		10	
	60 / 71	30		15		10	
MSY-DW	25 / 35 / 50	20		12		10	
MSY-TP	35 / 50	20		12		10	
MSZ-F MFZ	25 / 35	20		12		10	
	50	30		15		10	
MSZ-S	25 / 35 / 42	20		12		10	
	50 / 60	30		15		10	
MSZ-G	60 / 71	30		15		10	
MSZ-W MSZ-D	25 / 35	20		12		10	
MSZ-HJ	25 / 35 / 50	20		12		10	
	60 / 71	30		15		10	

## S SERIES & P SERIES

### Single type

Series	Class < Outdoor unit >	Maximum Piping Length (m)		Maximum Height Difference (m)		Maximum Number of Bends	
		Total length (A)	Indoor unit - Distribution pipe B	Outdoor unit - Indoor unit (H)	Indoor unit - Indoor unit h	Total number	Total number
Power Inverter (PUZ-ZM)	35 / 50	50		30		15	
	60 / 71	55		30		15	
	100 / 125 / 140	100		30		15	
Standard Inverter (PUZ-M & SUZ-M)	25 / 35	20		12		10	
	50 / 60 / 71	30		30		10	
	100	55		30		15	
	125 / 140	65					

### Twinn type

Series	Class < Outdoor unit >	Maximum Piping Length (m)			Maximum Height Difference (m)			Maximum Number of Bends
		Total length A+B+C	Pipe length difference from distribution pipe [B-C]	Indoor unit - Distribution pipe B	Outdoor unit - Indoor unit H	Indoor unit - Indoor unit h	Total number	
Power Inverter (PUZ-ZM)	71	55	8	20	30	1	15	
	100 / 125 / 140	100	8	20	30	1	15	
	200 / 250							
Standard Inverter (PUZ-M)	100	55	8	20	30	1	15	
	125 / 140	65						
	200 / 250							

### Triple type

Series	Class < Outdoor unit >	Maximum Piping Length (m)			Maximum Height Difference (m)			Maximum Number of Bends
		Total length A+B+C+D	Pipe length difference from distribution pipe [B-C]	Indoor unit - Distribution pipe B	Outdoor unit - Indoor unit H	Indoor unit - Indoor unit h	Total number	
Power Inverter (PUZ-ZM)	140	100	8	20	30	1	15	
	200 / 250							
Standard Inverter (PUZ-M)	140	65	8	20	30	1	15	
	200 / 250							

### Quadruple type

Series	Class < Outdoor unit >	Maximum Piping Length (m)			Maximum Height Difference (m)			Maximum Number of Bends
		Total length A+B+C+D+E	Pipe length difference from distribution pipe [B-C]	Indoor unit - Distribution pipe B	Outdoor unit - Indoor unit H	Indoor unit - Indoor unit h	Total number	
Power Inverter (PUZ-ZM)	200 / 250	100	8	30	30	1	15	
Standard Inverter (PUZ-M)	200 / 250	70	8	22	30	1	15	

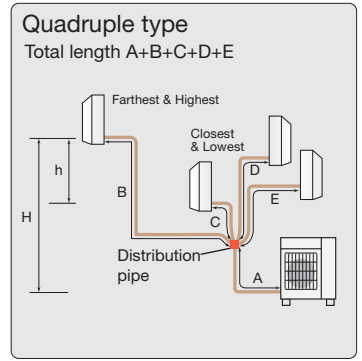
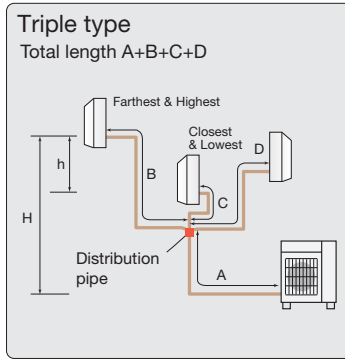
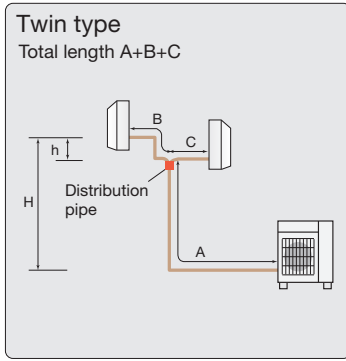
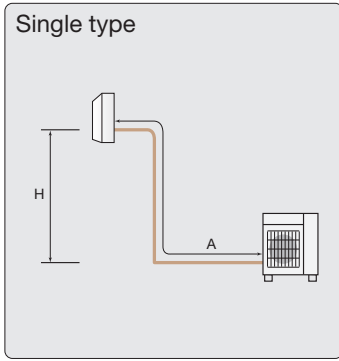

## MXZ SERIES

MXZ-2D33VA, MXZ-2F33VF4

Maximum Piping Length	
Outdoor unit - Indoor unit (a,b)	15m
Total length (a+b)	20m

Maximum Number of Bends	
Outdoor unit - Indoor unit (a,b)	15
Total number (a+b)	20

\* When connecting MFZ-KJ Series indoor unit, additional refrigerant is required. For details, please contact Mitsubishi Electric.

Regarding MXZ-2D33, the second unit should be a different type in the case of selecting one MFZ-KJ.

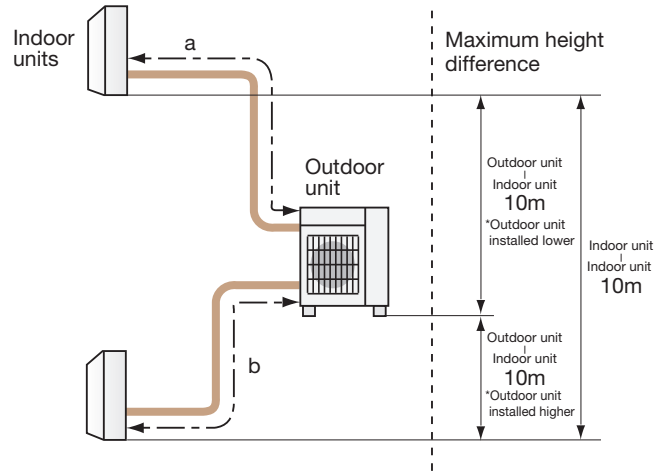

MXZ-2D42VA2, MXZ-2F42VF4

Maximum Piping Length	
Outdoor unit - Indoor unit (a,b)	20m
Total length (a+b)	30m

Maximum Number of Bends	
Outdoor unit - Indoor unit (a,b)	20
Total number (a+b)	30

MXZ-2D53VA(H)2, MXZ-2E53VAHZ, MXZ-2F53VF(H)4, MXZ-2F53VFHZ2

Maximum Piping Length	
Outdoor unit - Indoor unit (a,b)	20m
Total length (a+b)	30m

Maximum Number of Bends	
Outdoor unit - Indoor unit (a,b)	20
Total number (a+b)	30

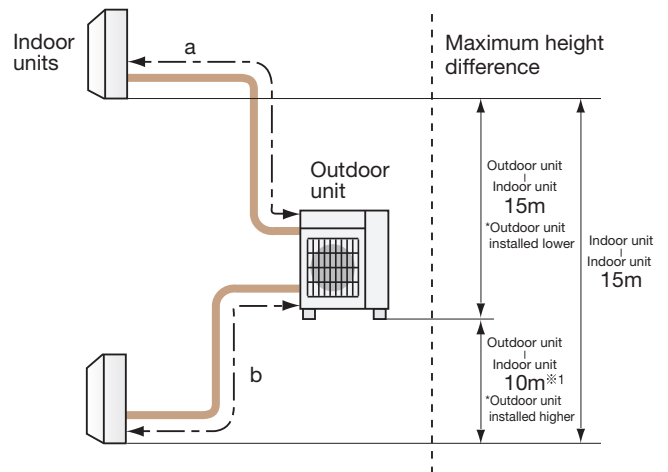

\* When connecting MFZ-KJ Series indoor unit to MXZ-2D42VA2 or MXZ-2D53VA(H)2, additional refrigerant is required. For details, please contact Mitsubishi Electric.

※1 in case of MXZ-2F53VFHZ2: 15m

## MXZ SERIES

MXZ-2DM40VA, MXZ-2HA40VF2, MXZ-2HA50VF2

Maximum Piping Length	
Outdoor unit - Indoor unit (a,b)	20m
Total length (a+b)	30m

Maximum Number of Bends	
Outdoor unit - Indoor unit (a,b)	20
Total number (a+b)	30

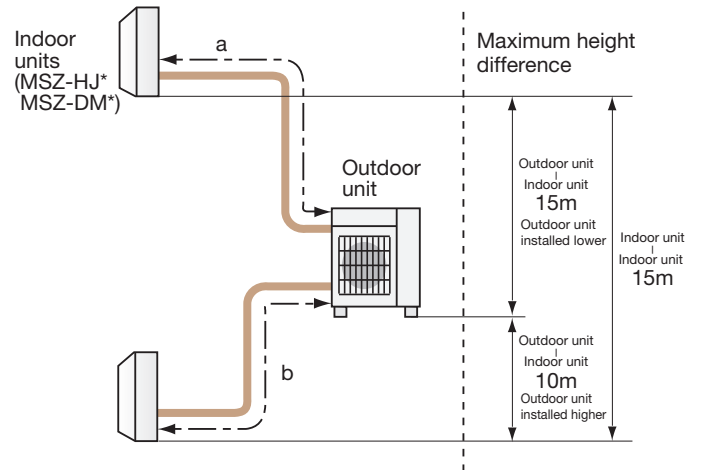

\* Only MSZ-HJ and DM model is connectable.

MXZ-3DM50VA, MXZ-3HA50VF2

Maximum Piping Length	
Outdoor unit - Indoor unit (a,b,c)	25m
Total length (a+b+c)	50m

Maximum Number of Bends	
Outdoor unit - Indoor unit (a,b,c)	25
Total number (a+b+c)	50

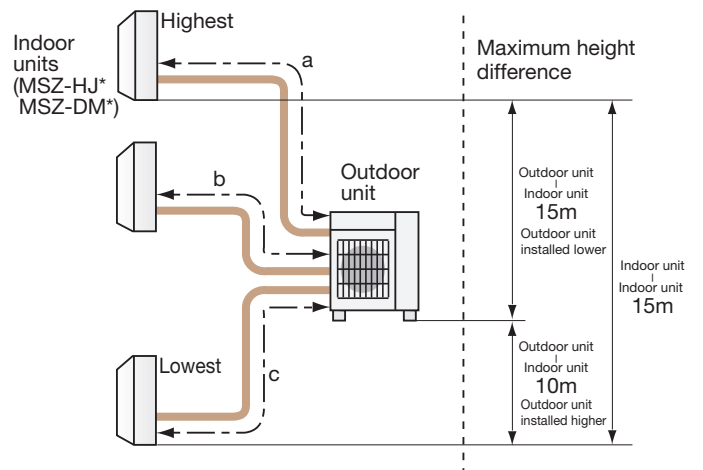

\* Only MSZ-HJ and DM model is connectable.

MXZ-3E54VA, MXZ-3F54VF4

Maximum Piping Length	
Outdoor unit - Indoor unit (a,b,c,d)	25m
Total length (a+b+c+d)	50m

Maximum Number of Bends	
Outdoor unit - Indoor unit (a,b,c,d)	25
Total number (a+b+c+d)	50

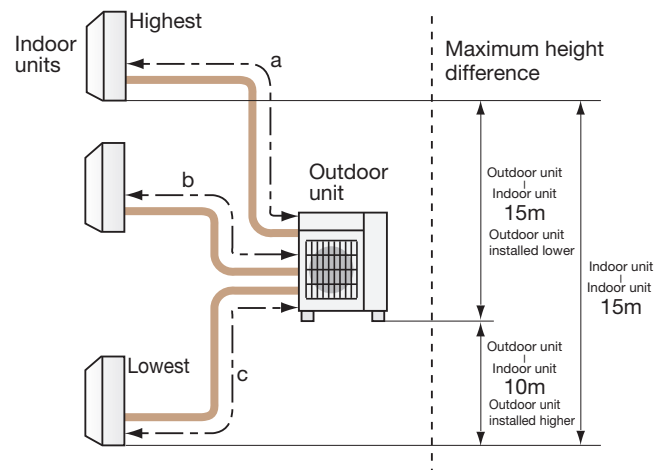

MXZ-4E72VA, MXZ-3F68VF4, MXZ-4F72VF4, MXZ-4F80VF4

Maximum Piping Length	
Outdoor unit - Indoor unit (a,b,c,d)	25m
Total length (a+b+c+d)	60m

Maximum Number of Bends	
Outdoor unit - Indoor unit (a,b,c,d)	25
Total number (a+b+c+d)	60

\* When connecting MFZ-KJ Series indoor unit, additional refrigerant is required. For details, please contact Mitsubishi Electric.

MXZ-4E83VA, MXZ-4E83VAHZ, MXZ-4F83VF2, MXZ-4F83VFHZ2

Maximum Piping Length	
Outdoor unit - Indoor unit (a,b,c,d)	25m
Total length (a+b+c+d)	70m

Maximum Number of Bends	
Outdoor unit - Indoor unit (a,b,c,d)	25
Total number (a+b+c+d)	70

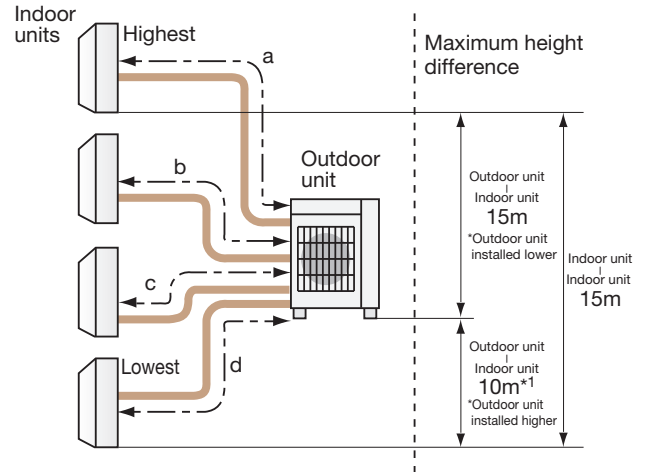

\*1 in case of MXZ-4F83VF2 and MXZ-4F83VFHZ2: 15m

MXZ-5E102VA, MXZ-5F102VF2

Maximum Piping Length	
Outdoor unit - Indoor unit (a,b,c,d,e)	25m
Total length (a+b+c+d+e)	80m

Maximum Number of Bends	
Outdoor unit - Indoor unit (a,b,c,d,e)	25
Total number (a+b+c+d+e)	80

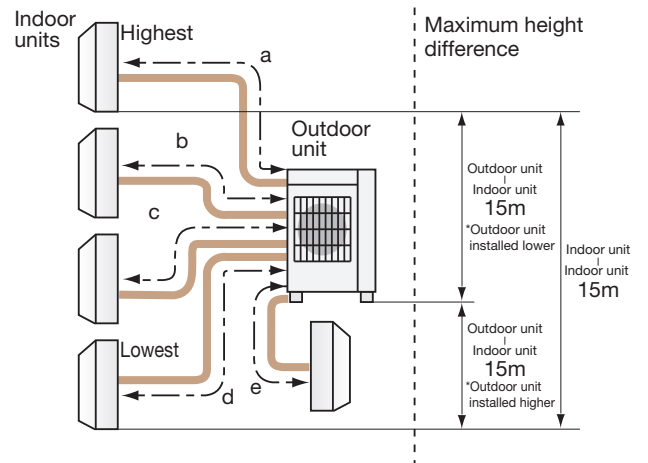

MXZ-6D122VA2, MXZ-6F120VF2

Maximum Piping Length	
Outdoor unit - Indoor unit (a,b,c,d,e,f)	25m
Total length (a+b+c+d+e+f)	80m

Maximum Number of Bends	
Outdoor unit - Indoor unit (a,b,c,d,e,f)	25
Total number (a+b+c+d+e+f)	80

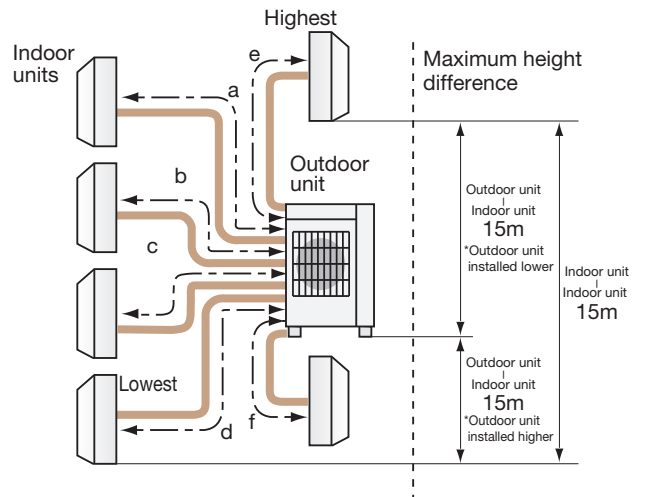

# PUMY SERIES

## PUMY-SP112/125/140V(Y)KM2

### 1-Branch box

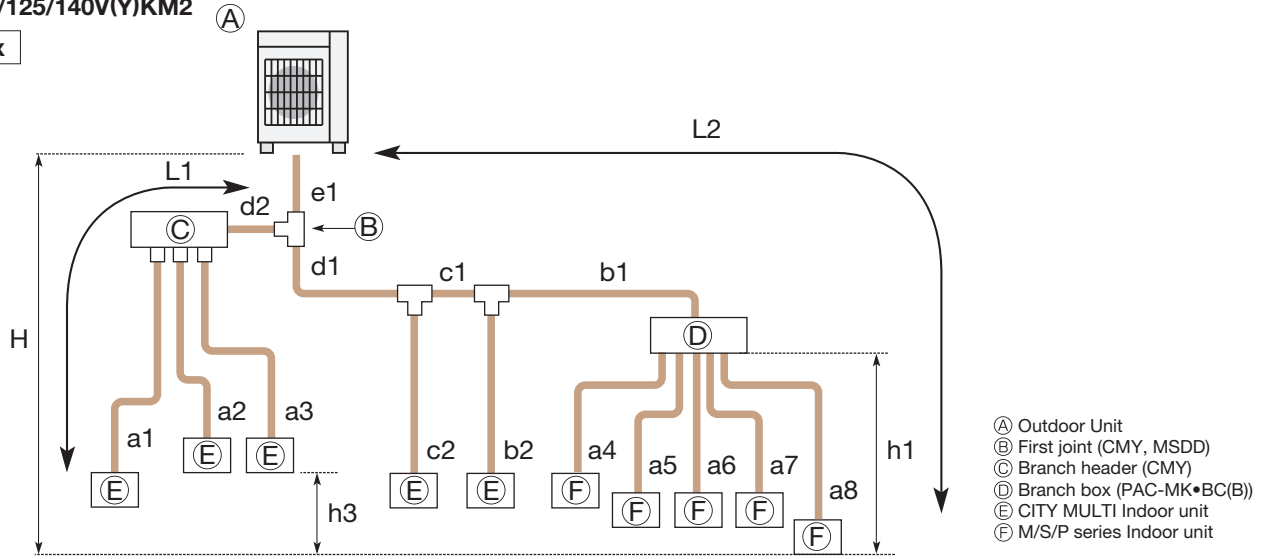

- Ⓐ Outdoor Unit
- Ⓑ First joint (CMY, MSDD)
- Ⓒ Branch header (CMY)
- Ⓓ Branch box (PAC-MK•BC(B))
- Ⓔ CITY MULTI Indoor unit
- Ⓕ M/S/P series Indoor unit

Permissible length (One-way)	Total piping length	$e1 + d1 + d2 + c1 + c2 + b1 + b2 + a1 + a2 + a3 + a4 + a5 + a6 + a7 + a8 \leq 120 \text{ m}$
	Farthest piping length (L1)	$e1 + d2 + a1$ or $e1 + d1 + c1 + b2 \leq 70 \text{ m}$
	Farthest piping length. Via Branch box (L2)	$e1 + d1 + c1 + b1 + a8 \leq 80 \text{ m}$
	Piping length between outdoor unit and branch box	$e1 + d1 + c1 + b1 \leq 55 \text{ m}$
	Farthest piping length from the first joint	$d1 + c1 + b1$ or $d1 + c1 + b2 \leq 50 \text{ m}$
	Farthest piping length after branch box	$a8 \leq 25 \text{ m}$
	Total piping length between branch boxes and indoor units	$a4 + a5 + a6 + a7 + a8 \leq 95 \text{ m}$
Permissible height difference (One-way)	In indoor/outdoor section (H)*1	$H \leq 50 \text{ m}$ (In case of outdoor unit is set higher than indoor unit) $H \leq 30 \text{ m}$ (In case of outdoor unit is set lower than indoor unit)
	In branch box/indoor unit section (h1)	$h1 \leq 15 \text{ m}$
	In each indoor unit (h3)	$h3 \leq 12 \text{ m}$
Number of bends		$ e1 + d2 + a1 ,  e1 + d2 + a2 ,  e1 + d2 + a3 ,  e1 + d1 + c2 ,  e1 + d1 + c1 + b2 ,  e1 + d1 + c1 + b1 + a4 ,  e1 + d1 + c1 + b1 + a5 ,  e1 + d1 + c1 + b1 + a6 ,  e1 + d1 + c1 + b1 + a7 ,  e1 + d1 + c1 + b1 + a8  \leq 15$

\*1: Branch box should be placed within the level between the outdoor unit and indoor units.

### 2-Branch boxes

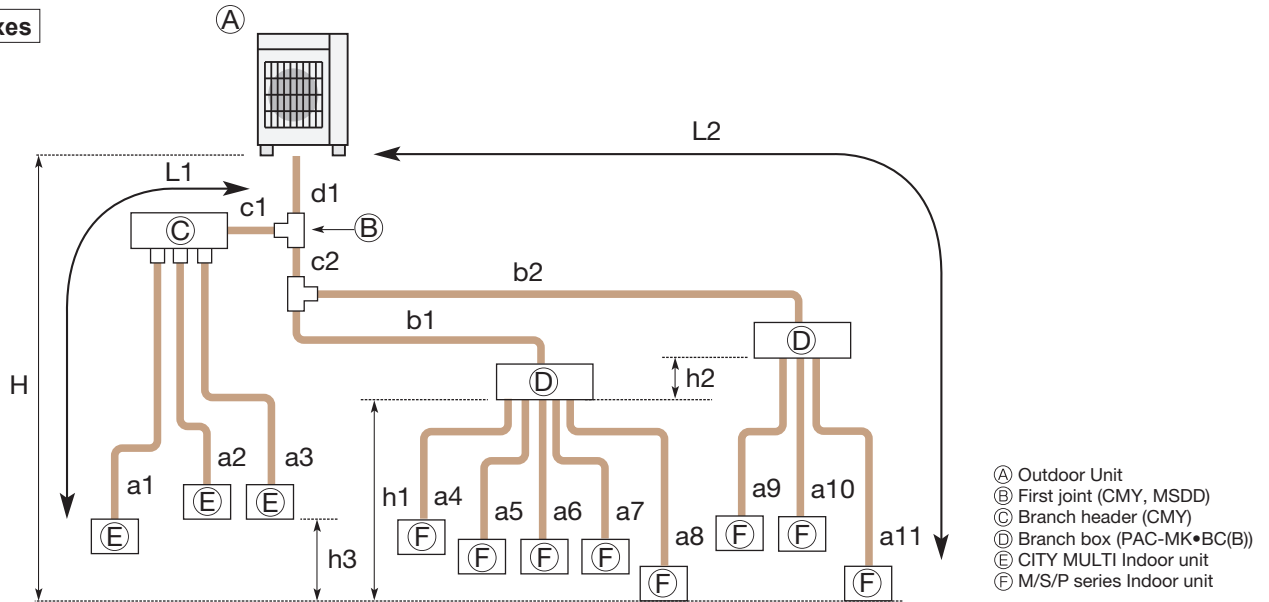

- Ⓐ Outdoor Unit
- Ⓑ First joint (CMY, MSDD)
- Ⓒ Branch header (CMY)
- Ⓓ Branch box (PAC-MK•BC(B))
- Ⓔ CITY MULTI Indoor unit
- Ⓕ M/S/P series Indoor unit

Permissible length (One-way)	Total piping length	$d1 + c1 + c2 + b1 + b2 + a1 + a2 + a3 + a4 + a5 + a6 + a7 + a8 + a9 + a10 + a11 \leq 120 \text{ m}$
	Farthest piping length (L1)	$d1 + c1 + a1 \leq 70 \text{ m}$
	Farthest piping length. Via Branch box (L2)	$d1 + c2 + b2 + a11 \leq 80 \text{ m}$
	Piping length between outdoor unit and branch boxes	$d1 + c2 + b1 + b2 \leq 55 \text{ m}$
	Farthest piping length from the first joint	$c2 + b2$ or $c1 + a1 \leq 50 \text{ m}$
	Farthest piping length after branch box	$a11 \leq 25 \text{ m}$
	Farthest branch box from outdoor unit	$d1 + c2 + b2 \leq 55 \text{ m}$
Total piping length between branch boxes and indoor units	$a4 + a5 + a6 + a7 + a8 + a9 + a10 + a11 \leq 95 \text{ m}$	
Permissible height difference (One-way)	In indoor/outdoor section (H)*1	$H \leq 50 \text{ m}$ (In case of outdoor unit is set higher than indoor unit) $H \leq 30 \text{ m}$ (In case of outdoor unit is set lower than indoor unit)
	In branch box/indoor unit section (h1)	$h1 + h2 \leq 15 \text{ m}$
	In each branch unit (h2)	$h2 \leq 15 \text{ m}$
	In each indoor unit (h3)	$h3 \leq 12 \text{ m}$
Number of bends		$ d1 + c1 + a1 ,  d1 + c1 + a2 ,  d1 + c1 + a3 ,  d1 + c2 + b1 + a4 ,  d1 + c2 + b1 + a5 ,  d1 + c2 + b1 + a6 ,  d1 + c2 + b1 + a7 ,  d1 + c2 + b1 + a8 ,  d1 + c2 + b2 + a9 ,  d1 + c2 + b2 + a10 ,  d1 + c2 + b2 + a11  \leq 15$

\*1: Branch box should be placed within the level between the outdoor unit and indoor units.

**PUMY-P112/125/140VKM6**  
**PUMY-P112/125/140YKM5**

**1-Branch box**

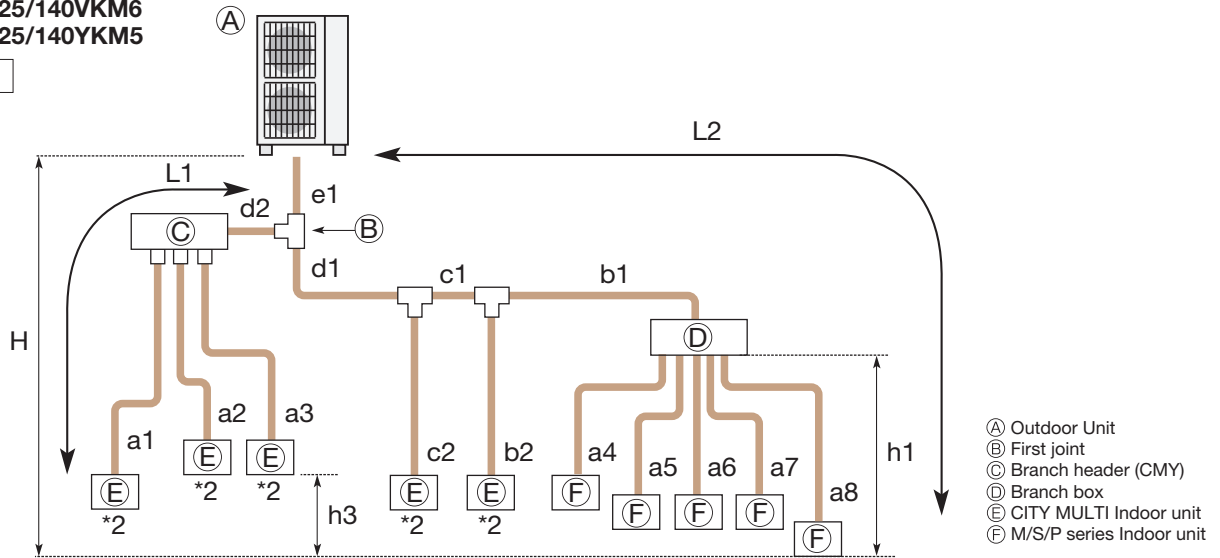

Permissible length (One-way)	Total piping length	$e1 + d1 + d2 + c1 + c2 + b1 + b2 + a1 + a2 + a3 + a4 + a5 + a6 + a7 + a8 \leq 300$ m
	Farthest piping length (L1)	$e1 + d2 + a1$ or $e1 + d1 + c1 + b2 \leq 85$ m
	Farthest piping length. Via Branch box (L2)	$e1 + d1 + c1 + b1 + a8 \leq 80$ m
	Piping length between outdoor unit and branch box	$e1 + d1 + c1 + b1 \leq 55$ m
	Farthest piping length from the first joint	$d1 + c1 + b1$ or $d1 + c1 + b2 \leq 30$ m
	Farthest piping length after branch box	$a8 \leq 25$ m
Permissible height difference (One-way)	Total piping length between branch boxes and indoor units	$a4 + a5 + a6 + a7 + a8 \leq 95$ m
	In indoor/outdoor section (H)*1	$H \leq 50$ m (In case of outdoor unit is set higher than indoor unit) $H \leq 40$ m (In case of outdoor unit is set lower than indoor unit)
	In branch box/indoor unit section (h1)	$h1 \leq 15$ m
Number of bends	In each indoor unit (h3)	$h3 \leq 12$ m
		$ e1 + d2 + a1 ,  e1 + d2 + a2 ,  e1 + d2 + a3 ,  e1 + d1 + c2 ,  e1 + d1 + c1 + b2 ,  e1 + d1 + c1 + b1 + a4 ,  e1 + d1 + c1 + b1 + a5 ,  e1 + d1 + c1 + b1 + a6 ,  e1 + d1 + c1 + b1 + a7 ,  e1 + d1 + c1 + b1 + a8  \leq 15$

\*1: Branch box should be placed within the level between the outdoor unit and indoor units.

\*2: PKFY-P-VBM, PKFY-P10-32VLM, PFFY-P-VKM, PFFY-P-VCM, and PFFY-P-VL\* type indoor units cannot be used in a mixed system.

**2-Branch boxes**

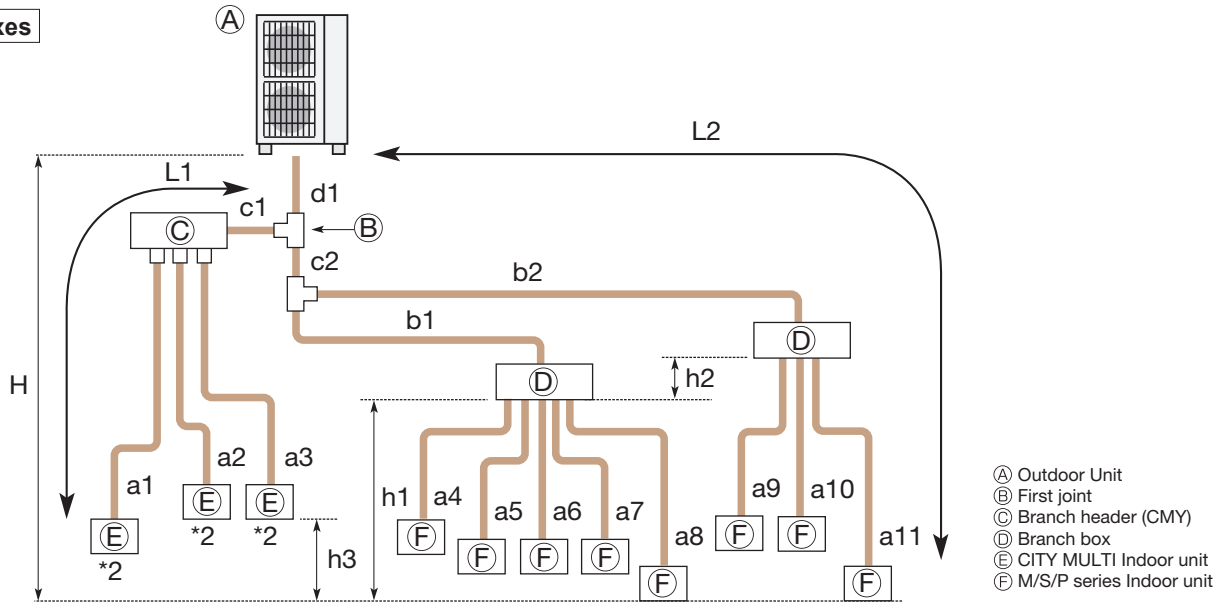

Permissible length (One-way)	Total piping length	$d1 + c1 + c2 + b1 + b2 + a1 + a2 + a3 + a4 + a5 + a6 + a7 + a8 + a9 + a10 + a11 \leq 240$ m
	Farthest piping length (L1)	$d1 + c1 + a1 \leq 85$ m
	Farthest piping length. Via Branch box (L2)	$d1 + c2 + b2 + a11 \leq 80$ m
	Piping length between outdoor unit and branch boxes	$d1 + c2 + b1 + b2 \leq 55$ m
	Farthest piping length from the first joint	$c2 + b2$ or $c1 + a1 \leq 30$ m
	Farthest piping length after branch box	$a11 \leq 25$ m
Permissible height difference (One-way)	Total piping length between branch boxes and indoor units	$a4 + a5 + a6 + a7 + a8 + a9 + a10 + a11 \leq 95$ m
	In indoor/outdoor section (H)*1	$H \leq 50$ m (In case of outdoor unit is set higher than indoor unit) $H \leq 40$ m (In case of outdoor unit is set lower than indoor unit)
	In branch box/indoor unit section (h1)	$h1 + h2 \leq 15$ m
Number of bends	In each branch unit (h2)	$h2 \leq 15$ m
	In each indoor unit (h3)	$h3 \leq 12$ m
		$ d1 + c1 + a1 ,  d1 + c1 + a2 ,  d1 + c1 + a3 ,  d1 + c2 + b1 + a4 ,  d1 + c2 + b1 + a5 ,  d1 + c2 + b1 + a6 ,  d1 + c2 + b1 + a7 ,  d1 + c2 + b1 + a8 ,  d1 + c2 + b2 + a9 ,  d1 + c2 + b2 + a10 ,  d1 + c2 + b2 + a11  \leq 15$

\*1: Branch box should be placed within the level between the outdoor unit and indoor units.

\*2: PKFY-P-VBM, PKFY-P10-32VLM, PFFY-P-VKM, PFFY-P-VCM, and PFFY-P-VL\* type indoor units cannot be used in a mixed system.

PUMY-P200YKM3(-BS)

1-Branch box

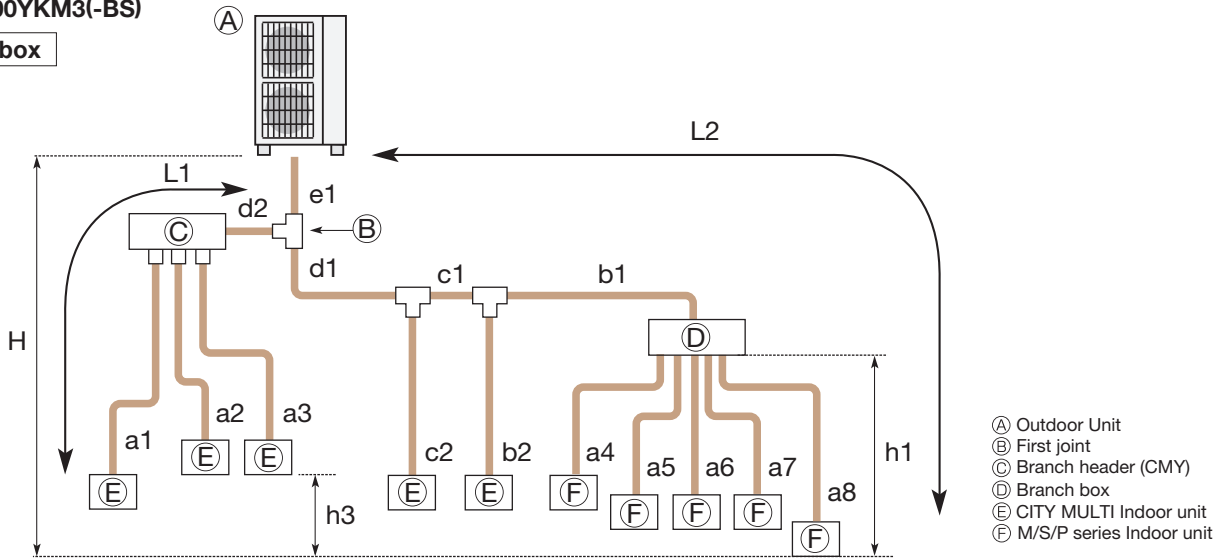

- Ⓐ Outdoor Unit
- Ⓑ First joint
- Ⓒ Branch header (CMY)
- Ⓓ Branch box
- Ⓔ CITY MULTI Indoor unit
- Ⓕ M/S/P series Indoor unit

Permissible length (One-way)	Total piping length	$e1 + d1 + d2 + c1 + c2 + b1 + b2 + a1 + a2 + a3 + a4 + a5 + a6 + a7 + a8 \leq 150 \text{ m}$
	Farthest piping length (L1)	$e1 + d2 + a1 \text{ or } e1 + d1 + c1 + b2 \leq 80 \text{ m}$
	Farthest piping length. Via Branch box (L2)	$e1 + d1 + c1 + b1 + a8 \leq 80 \text{ m}$
	Piping length between outdoor unit and branch box	$e1 + d1 + c1 + b1 \leq 55 \text{ m}$
	Farthest piping length from the first joint	$d1 + c1 + b1 \text{ or } d1 + c1 + b2 \leq 30 \text{ m}$
	Farthest piping length after branch box	$a8 \leq 25 \text{ m}$
	Total piping length between branch boxes and indoor units	$a4 + a5 + a6 + a7 + a8 \leq 95 \text{ m}$
Permissible height difference (One-way)	In indoor/outdoor section (H)*1	$H \leq 50 \text{ m}$ (In case of outdoor unit is set higher than indoor unit) $H \leq 40 \text{ m}$ (In case of outdoor unit is set lower than indoor unit)
	In branch box/indoor unit section (h1)	$h1 \leq 15 \text{ m}$
	In each indoor unit (h3)	$h3 \leq 12 \text{ m}$
Number of bends		$ e1 + d2 + a1 ,  e1 + d2 + a2 ,  e1 + d2 + a3 ,  e1 + d1 + c2 ,  e1 + d1 + c1 + b2 ,  e1 + d1 + c1 + b1 + a4 ,  e1 + d1 + c1 + b1 + a5 ,  e1 + d1 + c1 + b1 + a6 ,  e1 + d1 + c1 + b1 + a7 ,  e1 + d1 + c1 + b1 + a8  \leq 15$

\*1: Branch box should be placed within the level between the outdoor unit and indoor units.

2-Branch boxes

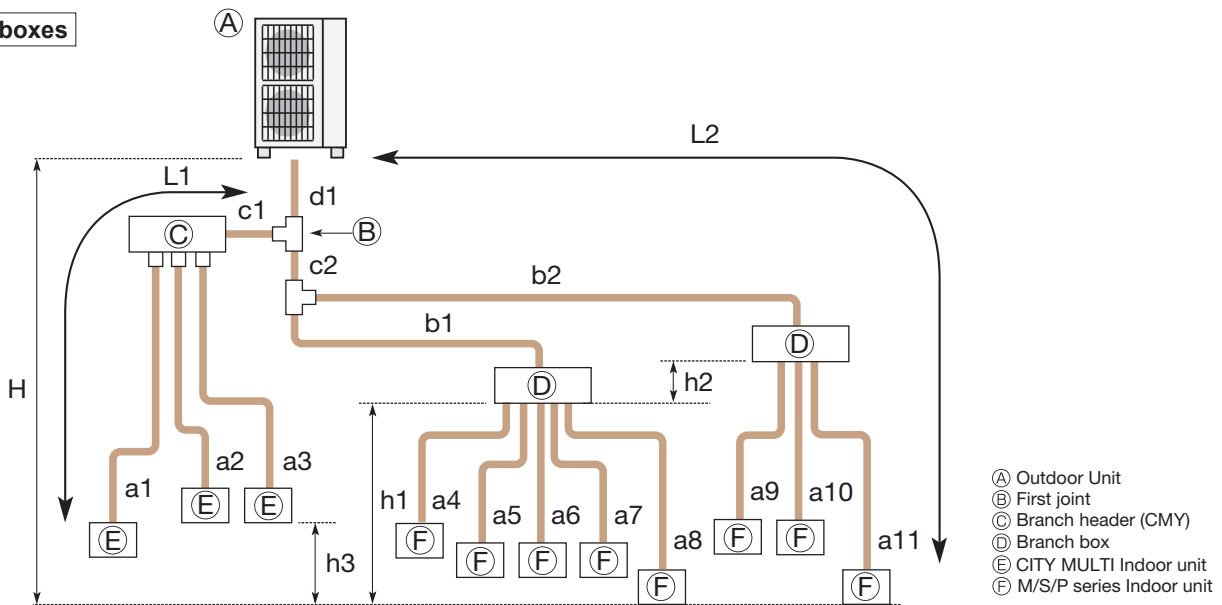

- Ⓐ Outdoor Unit
- Ⓑ First joint
- Ⓒ Branch header (CMY)
- Ⓓ Branch box
- Ⓔ CITY MULTI Indoor unit
- Ⓕ M/S/P series Indoor unit

Permissible length (One-way)	Total piping length	$d1 + c1 + c2 + b1 + b2 + a1 + a2 + a3 + a4 + a5 + a6 + a7 + a8 + a9 + a10 + a11 \leq 150 \text{ m}$
	Farthest piping length (L1)	$d1 + c1 + a1 \leq 80 \text{ m}$
	Farthest piping length. Via Branch box (L2)	$d1 + c2 + b2 + a11 \leq 80 \text{ m}$
	Piping length between outdoor unit and branch boxes	$d1 + c2 + b1 + b2 \leq 55 \text{ m}$
	Farthest piping length from the first joint	$c2 + b2 \text{ or } c1 + a1 \leq 30 \text{ m}$
	Farthest piping length after branch box	$a11 \leq 25 \text{ m}$
	Farthest branch box from outdoor unit	$d1 + c2 + b2 \leq 55 \text{ m}$
	Total piping length between branch boxes and indoor units	$a4 + a5 + a6 + a7 + a8 + a9 + a10 + a11 \leq 95 \text{ m}$
Permissible height difference (One-way)	In indoor/outdoor section (H)*1	$H \leq 50 \text{ m}$ (In case of outdoor unit is set higher than indoor unit) $H \leq 40 \text{ m}$ (In case of outdoor unit is set lower than indoor unit)
	In branch box/indoor unit section (h1)	$h1 + h2 \leq 15 \text{ m}$
	In each branch unit (h2)	$h2 \leq 15 \text{ m}$
	In each indoor unit (h3)	$h3 \leq 12 \text{ m}$
Number of bends		$ d1 + c1 + a1 ,  d1 + c1 + a2 ,  d1 + c1 + a3 ,  d1 + c2 + b1 + a4 ,  d1 + c2 + b1 + a5 ,  d1 + c2 + b1 + a6 ,  d1 + c2 + b1 + a7 ,  d1 + c2 + b1 + a8 ,  d1 + c2 + b2 + a9 ,  d1 + c2 + b2 + a10 ,  d1 + c2 + b2 + a11  \leq 15$

\*1: Branch box should be placed within the level between the outdoor unit and indoor units.



**PUMY-P250/300YBM2(-BS)**

**1-Branch box**

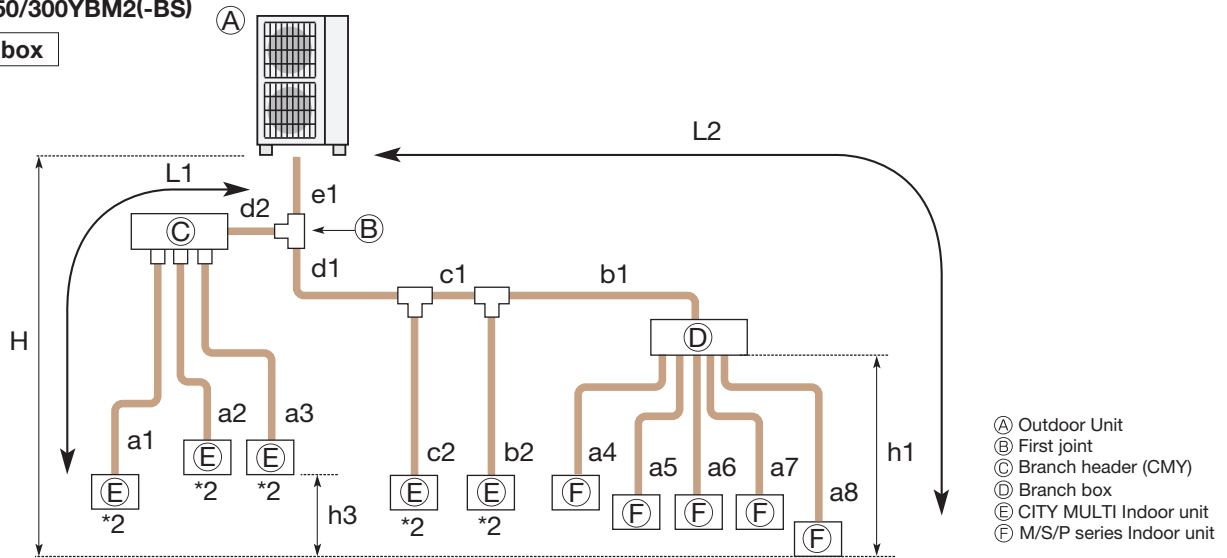

- Ⓐ Outdoor Unit
- Ⓑ First joint
- Ⓒ Branch header (CMY)
- Ⓓ Branch box
- Ⓔ CITY MULTI Indoor unit
- Ⓕ M/S/P series Indoor unit

Permissible length (One-way)	Total piping length	$e1 + d1 + d2 + c1 + c2 + b1 + b2 + a1 + a2 + a3 + a4 + a5 + a6 + a7 + a8 \leq 310$ m
	Farthest piping length (L1)	$e1 + d2 + a1$ or $e1 + d1 + c1 + b2 \leq 85$ m
	Farthest piping length. Via Branch box (L2)	$e1 + d1 + c1 + b1 + a8 \leq 80$ m
	Piping length between outdoor unit and branch box	$e1 + d1 + c1 + b1 \leq 80$ m
	Farthest piping length from the first joint	$d1 + c1 + b1$ or $d1 + c1 + b2 \leq 30$ m
	Farthest piping length after branch box	$a8 \leq 25$ m
Permissible height difference (One-way)	Total piping length between branch boxes and indoor units	$a4 + a5 + a6 + a7 + a8 \leq 145$ m
	In indoor/outdoor section (H)*1	$H \leq 50$ m (In case of outdoor unit is set higher than indoor unit) $H \leq 40$ m (In case of outdoor unit is set lower than indoor unit)
	In branch box/indoor unit section (h1)	$h1 \leq 15$ m
Number of bends	In each indoor unit (h3)	$h3 \leq 12$ m
		$ e1 + d2 + a1 ,  e1 + d2 + a2 ,  e1 + d2 + a3 ,  e1 + d1 + c2 ,  e1 + d1 + c1 + b2 ,  e1 + d1 + c1 + b1 + a4 ,  e1 + d1 + c1 + b1 + a5 ,  e1 + d1 + c1 + b1 + a6 ,  e1 + d1 + c1 + b1 + a7 ,  e1 + d1 + c1 + b1 + a8  \leq 23$

\*1: Branch box should be placed within the level between the outdoor unit and indoor units.  
\*2: PKFY-P-VBM, PKFY-P10-32VLM, PFFY-P-VKM, PFFY-P-VCM, and PFFY-P-VL\* type indoor units cannot be used in a mixed system.

**2-Branch boxes**

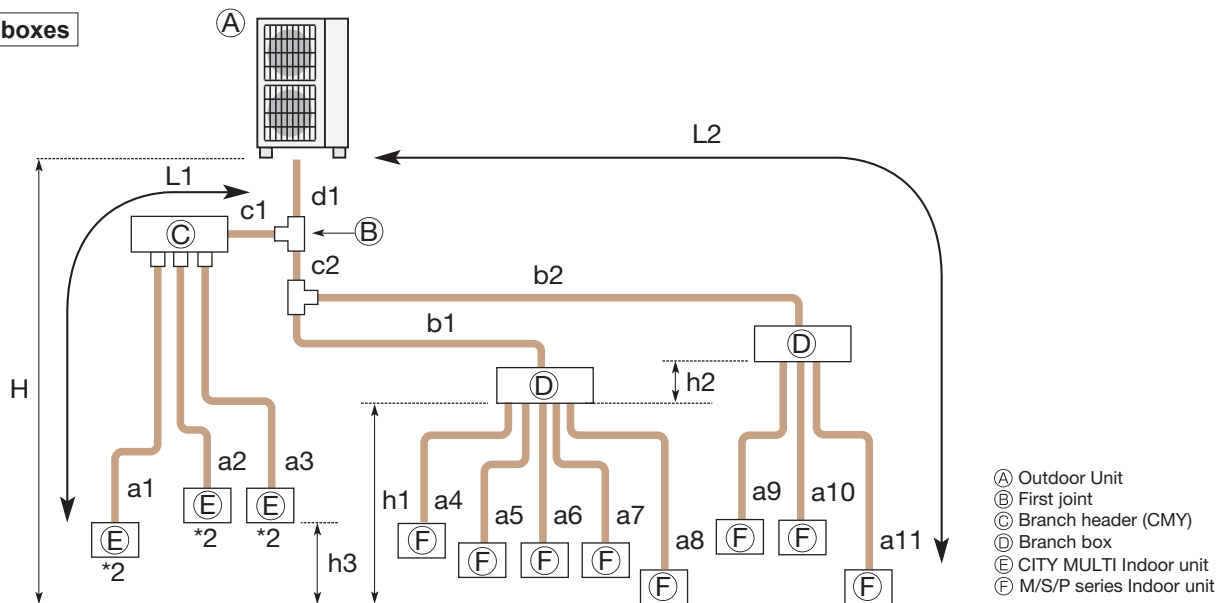

- Ⓐ Outdoor Unit
- Ⓑ First joint
- Ⓒ Branch header (CMY)
- Ⓓ Branch box
- Ⓔ CITY MULTI Indoor unit
- Ⓕ M/S/P series Indoor unit

Permissible length (One-way)	Total piping length	$d1 + c1 + c2 + b1 + b2 + a1 + a2 + a3 + a4 + a5 + a6 + a7 + a8 + a9 + a10 + a11 \leq 310$ m
	Farthest piping length (L1)	$d1 + c1 + a1 \leq 85$ m
	Farthest piping length. Via Branch box (L2)	$d1 + c2 + b2 + a11 \leq 80$ m
	Piping length between outdoor unit and branch boxes	$d1 + c2 + b1 + b2 \leq 95$ m
	Farthest piping length from the first joint	$c2 + b2$ or $c1 + a1 \leq 30$ m
	Farthest piping length after branch box	$a11 \leq 25$ m
Permissible height difference (One-way)	Total piping length between branch boxes and indoor units	$a4 + a5 + a6 + a7 + a8 + a9 + a10 + a11 \leq 145$ m
	In indoor/outdoor section (H)*1	$H \leq 50$ m (In case of outdoor unit is set higher than indoor unit) $H \leq 40$ m (In case of outdoor unit is set lower than indoor unit)
	In branch box/indoor unit section	$h1 + h2 \leq 15$ m
	In each branch unit (h2)	$h2 \leq 15$ m
Number of bends	In each indoor unit (h3)	$h3 \leq 12$ m
		$ d1 + c1 + a1 ,  d1 + c1 + a2 ,  d1 + c1 + a3 ,  d1 + c2 + b1 + a4 ,  d1 + c2 + b1 + a5 ,  d1 + c2 + b1 + a6 ,  d1 + c2 + b1 + a7 ,  d1 + c2 + b1 + a8 ,  d1 + c2 + b2 + a9 ,  d1 + c2 + b2 + a10 ,  d1 + c2 + b2 + a11  \leq 23$

\*1: Branch box should be placed within the level between the outdoor unit and indoor units.  
\*2: PKFY-P-VBM, PKFY-P10-32VLM, PFFY-P-VKM, PFFY-P-VCM, and PFFY-P-VL\* type indoor units cannot be used in a mixed system.

PUMY-P250/300YBM2(-BS)

3-Branch boxes

- Ⓐ Outdoor Unit
- Ⓑ First joint
- Ⓒ Branch header (CMY)
- Ⓓ Branch box
- Ⓔ CITY MULTI Indoor unit
- Ⓕ M/S/P series Indoor unit

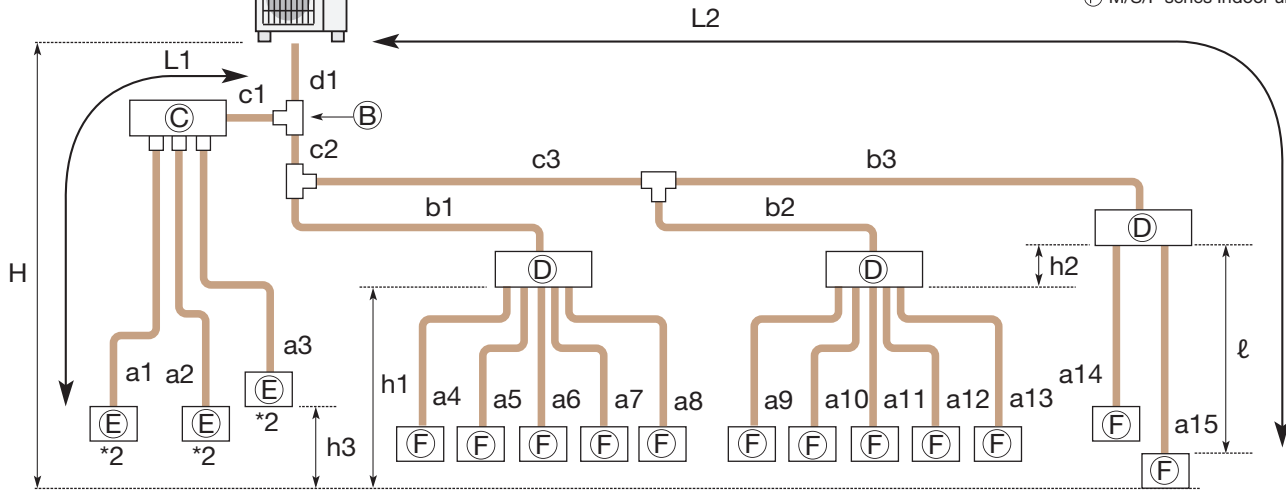

Permissible length (One-way)	Total piping length	$d1 + c1 + c2 + c3 + b1 + b2 + b3 + a1 + a2 + a3 + a4 + a5 + a6 + a7 + a8 + a9 + a10 + a11 + a12 + a13 + a14 + a15 \leq 310$ m
	Farthest piping length (L1)	$d1 + c1 + a1 \leq 85$ m
	Farthest piping length. Via Branch box (L2)	$d1 + c2 + c3 + b3 + a15 \leq 80$ m
	Piping length between outdoor unit and branch boxes	$d1 + c2 + c3 + b1 + b2 + b3 \leq 95$ m
	Farthest piping length from the first joint	$c2 + c3 + b3$ or $c1 + a1 \leq 30$ m
	Farthest piping length after branch box (l)	$a15 \leq 25$ m
	Total piping length between branch boxes and indoor units	$a4 + a5 + a6 + a7 + a8 + a9 + a10 + a11 + a12 + a13 + a14 + a15 \leq 145$ m
Permissible height difference (One-way)	In indoor/outdoor section (H)*1	$H \leq 50$ m (In case of outdoor unit is set higher than indoor unit) $H \leq 40$ m (In case of outdoor unit is set lower than indoor unit)
	In branch box/indoor unit section	$h1 + h2 \leq 15$ m
	In each branch unit (h2)	$h2 \leq 15$ m
	In each indoor unit (h3)	$h3 \leq 12$ m
Number of bends	$ d1 + c1 + a1 ,  d1 + c1 + a2 ,  d1 + c1 + a3 ,$ $ d1 + c2 + b1 + a4 ,  d1 + c2 + b1 + a5 ,  d1 + c2 + b1 + a6 ,  d1 + c2 + b1 + a7 ,$ $ d1 + c2 + b1 + a8 ,  d1 + c2 + c3 + b2 + a9 ,  d1 + c2 + c3 + b2 + a10 ,$ $ d1 + c2 + c3 + b2 + a11 ,  d1 + c2 + c3 + b2 + a12 ,  d1 + c2 + c3 + b2 + a13 ,$ $ d1 + c2 + c3 + b3 + a14 ,  d1 + c2 + c3 + b3 + a15  \leq 23$	

\*1: Branch box should be placed within the level between the outdoor unit and indoor units.

\*2: PKFY-P-VBM, PKFY-P10-32VLM, PFFY-P-VKM, PFFY-P-VCM, and PFFY-P-VL\* type indoor units cannot be used in a mixed system.

**PUMY-SM112/125/140V(Y)KM**

**1-Branch box**

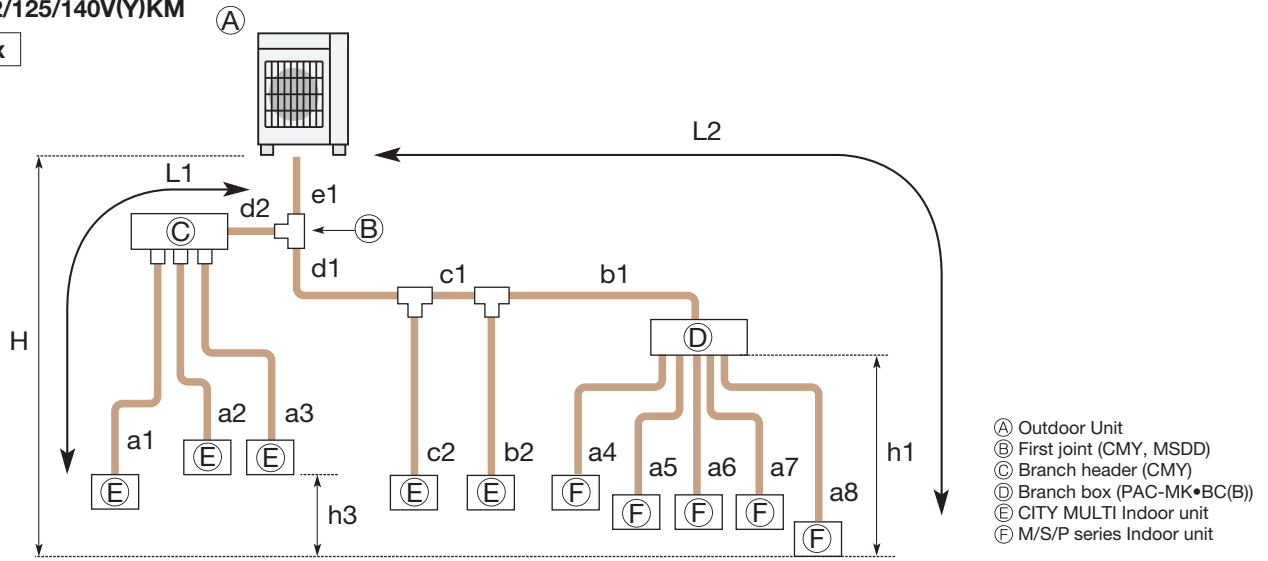

- Ⓐ Outdoor Unit
- Ⓑ First joint (CMY, MSDD)
- Ⓒ Branch header (CMY)
- Ⓓ Branch box (PAC-MK•BC(B))
- Ⓔ CITY MULTI Indoor unit
- Ⓕ M/S/P series Indoor unit

Permissible length (One-way)	Total piping length	$e1 + d1 + d2 + c1 + c2 + b1 + b2 + a1 + a2 + a3 + a4 + a5 + a6 + a7 + a8 \leq 120 \text{ m}$
	Farthest piping length (L1)	$e1 + d2 + a1 \text{ or } e1 + d1 + c1 + b2 \leq 70 \text{ m}$
	Farthest piping length. Via Branch box (L2)	$e1 + d1 + c1 + b1 + a8 \leq 80 \text{ m}$
	Piping length between outdoor unit and branch box	$e1 + d1 + c1 + b1 \leq 55 \text{ m}$
	Farthest piping length from the first joint	$d1 + c1 + b1 \text{ or } d1 + c1 + b2 \leq 50 \text{ m}$
	Farthest piping length after branch box	$a8 \leq 25 \text{ m}$
	Total piping length between branch boxes and indoor units	$a4 + a5 + a6 + a7 + a8 \leq 95 \text{ m}$
Permissible height difference (One-way)	In indoor/outdoor section (H)*1	$H \leq 50 \text{ m}$ (In case of outdoor unit is set higher than indoor unit) $H \leq 40 \text{ m}$ (In case of outdoor unit is set lower than indoor unit)
	In branch box/indoor unit section (h1)	$h1 \leq 15 \text{ m}$
	In each indoor unit (h3)	$h3 \leq 12 \text{ m}$
Number of bends	$ e1 + d2 + a1 ,  e1 + d2 + a2 ,  e1 + d2 + a3 ,  e1 + d1 + c2 ,  e1 + d1 + c1 + b2 ,$ $ e1 + d1 + c1 + b1 + a4 ,  e1 + d1 + c1 + b1 + a5 ,  e1 + d1 + c1 + b1 + a6 ,$ $ e1 + d1 + c1 + b1 + a7 ,  e1 + d1 + c1 + b1 + a8  \leq 15$	

\*1: Branch box should be placed within the level between the outdoor unit and indoor units.

**2-Branch boxes**

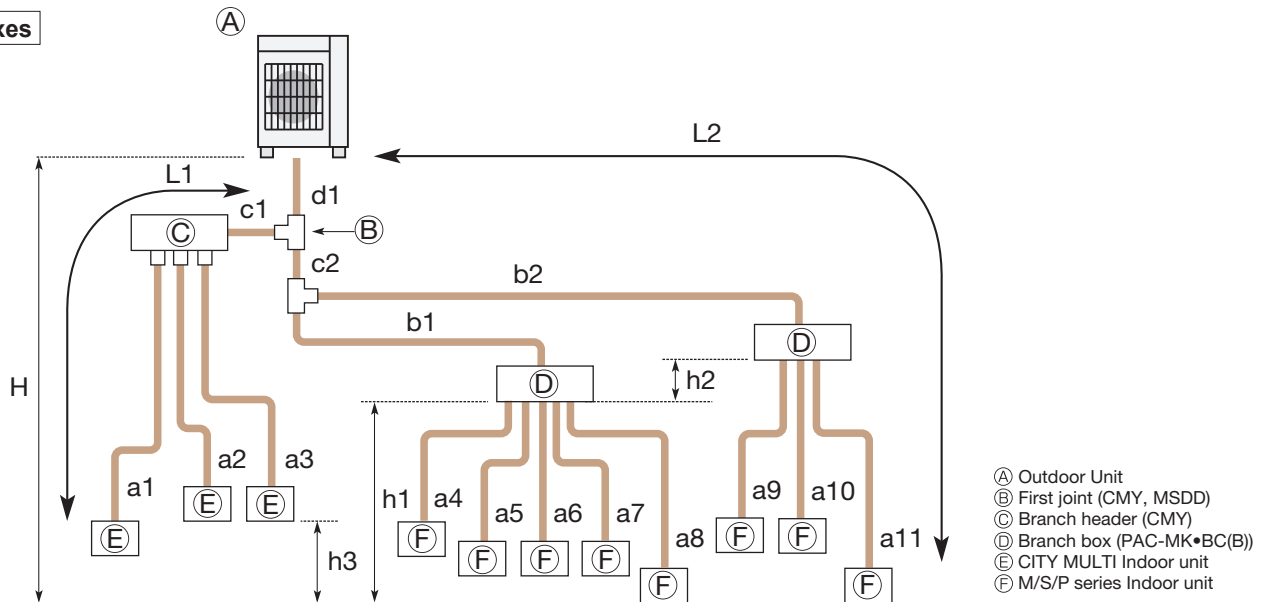

- Ⓐ Outdoor Unit
- Ⓑ First joint (CMY, MSDD)
- Ⓒ Branch header (CMY)
- Ⓓ Branch box (PAC-MK•BC(B))
- Ⓔ CITY MULTI Indoor unit
- Ⓕ M/S/P series Indoor unit

Permissible length (One-way)	Total piping length	$d1 + c1 + c2 + b1 + b2 + a1 + a2 + a3 + a4 + a5 + a6 + a7 + a8 + a9 + a10 + a11 \leq 120 \text{ m}$
	Farthest piping length (L1)	$d1 + c1 + a1 \leq 70 \text{ m}$
	Farthest piping length. Via Branch box (L2)	$d1 + c2 + b2 + a11 \leq 80 \text{ m}$
	Piping length between outdoor unit and branch boxes	$d1 + c2 + b1 + b2 \leq 55 \text{ m}$
	Farthest piping length from the first joint	$c2 + b2 \text{ or } c1 + a1 \leq 50 \text{ m}$
	Farthest piping length after branch box	$a11 \leq 25 \text{ m}$
	Farthest branch box from outdoor unit	$d1 + c2 + b2 \leq 55 \text{ m}$
Total piping length between branch boxes and indoor units	$a4 + a5 + a6 + a7 + a8 + a9 + a10 + a11 \leq 95 \text{ m}$	
Permissible height difference (One-way)	In indoor/outdoor section (H)*1	$H \leq 50 \text{ m}$ (In case of outdoor unit is set higher than indoor unit) $H \leq 40 \text{ m}$ (In case of outdoor unit is set lower than indoor unit)
	In branch box/indoor unit section (h1)	$h1 + h2 \leq 15 \text{ m}$
	In each branch unit (h2)	$h2 \leq 15 \text{ m}$
	In each indoor unit (h3)	$h3 \leq 12 \text{ m}$
Number of bends	$ d1 + c1 + a1 ,  d1 + c1 + a2 ,  d1 + c1 + a3 ,  d1 + c2 + b1 + a4 ,  d1 + c2 + b1 + a5 ,$ $ d1 + c2 + b1 + a6 ,  d1 + c2 + b1 + a7 ,  d1 + c2 + b1 + a8 ,  d1 + c2 + b2 + a9 ,$ $ d1 + c2 + b2 + a10 ,  d1 + c2 + b2 + a11  \leq 15$	

\*1: Branch box should be placed within the level between the outdoor unit and indoor units.

# Explanation of Terminology

## Maximum piping length:

This is the [maximum allowable length of the refrigerant piping](#). The amount of refrigerant pipe used cannot be longer than the length specified.

### Total length:

The maximum allowable combined length of all the refrigerant piping between the outdoor unit and indoor unit(s).

### Outdoor Unit - Indoor Unit:

The maximum allowable length of the refrigerant piping between the outdoor unit and indoor units installed when multiple units are connected to a single outdoor unit. This distance limitation refers to the maximum length between the outdoor unit and the farthest indoor unit.

### Pipe length difference from distribution pipe:

The maximum allowable difference in refrigerant piping length from the distribution pipe to the farthest indoor unit and from the distribution pipe to the closest indoor unit when multiple indoor units are connected to a single outdoor unit using a distribution pipe.

### Indoor Unit - Distribution Pipe:

The maximum allowable length of the refrigerant piping between indoor units and the distribution pipe when multiple indoor units are connected to a single outdoor unit.

## Maximum height difference:

This is the [maximum allowable height difference](#). It is necessary to install the air conditioning system so that the height distance is no more than the difference specified. (Specified differences may vary if the outdoor unit is installed higher or lower than the indoor units).

### Outdoor unit - Indoor unit:

The maximum allowable difference in height between the outdoor unit and indoor units when installed (when multiple indoor units are connected to a single outdoor unit, this distance limitation refers to the maximum height difference between the outdoor unit and an indoor unit).

### Indoor unit - Indoor unit:

The maximum allowable difference between the heights of indoor units when multiple indoor units are connected to a single outdoor unit.

## Maximum number of bends:

This is the [maximum allowable number of bends in the refrigerant piping](#). The total number of bends in the refrigerant piping used cannot exceed the number specified.

### Total number:

The maximum allowable number of bends for all refrigerant piping between the outdoor unit and indoor units.

### Outdoor unit - Indoor unit:

The maximum allowable number of bends between the outdoor unit and each indoor unit when multiple indoor units are connected to a single outdoor unit.



# Conditions for specifications

Temperature conditions are based on JIS B8616.

Cooling	Indoor	27°C DB, 19°C WB
	Outdoor	35°C DB, 24°C WB
Heating	Indoor	20°C DB
	Outdoor	7°C DB, 6°C WB

Refrigerant piping length ; 5m

The figures for total input are based on the following voltages.

Series	Indoor unit	Outdoor unit
M Series S Series P Series (except for PEA) MXZ Series POWERFUL HEATING Series	-	VF, VG, VE, VA, VHA, VKA: 230V/Single phase/50Hz YA, YHA, YKA: 400V/Three phase/50Hz
PEA Series	400V/Three phase/50Hz	400V/Three phase/50Hz

Sound pressure level

- The sound pressure measurement is conducted in an anechoic chamber.
- The actual sound level depends on the distance from the unit and the acoustic environment.

## How to read a model name

### 1) M & S Series

M	M : M Series S : S Series
S	"S"= Wall-mounted , "F"= Compact floor-standing , "E"= Compact ceiling-concealed , "L"= 4- or 1-way cassette , "U"= Outdoor unit
Z	"Z"= Inverter heat pump , "H"= Fixed-speed heat pump , "blank"= Cooling only of Non-inverter , "Y"= Cooling only of inverter
-	
F	Series
H	Generation
25	Rated cooling capacity (kW base)
V	230V / Single phase / 50Hz
E	"A"= R410A with new A control , "B"= R410A with conventional control , "E"= R410A with new A control & ErP correspondance , "G"=R32 with new A control & ErP correspondance , "F"= R32 with new A control
HZ	"HZ"= Hyper Heating model , "H"= Anti-freeze heater equipped model , "S"= Silver indoor unit , "W"= White/Natural White indoor unit , "B"= Black/Onyx Black indoor unit , "V"= Pearl White indoor unit , "R"= Ruby Red indoor unit

### 2) P Series

P	P Series
U	"K"= Wall-mounted , "S"= Floor-standing , "L"= 4-way cassette , "E"= Ceiling-concealed , "C"= Ceiling-suspended , "U"= Outdoor unit
H	"H"= For heating and cooling
Z	"Z"= Inverter
-	
ZM/M	"ZM"= R32 Eco-conscious Power Inverter , "M"= R32 &R410A
71	Rated cooling capacity (kW base)
V	"V"= 230V / Single phase / 50Hz , "Y"= 400V / Three phase / 50Hz
H	Generation
A	"A"= A control

### 3) MXZ Series

M	M Series
X	Multi-system outdoor unit (heat pump)
Z	Inverter heat pump
-	
4	Maximum number of connectable indoor units
D/E/F/HJ/DM/HA	Generation / Type
72	Rated cooling capacity (kW base)
V	"V"= 230V / Single phase / 50Hz , "F"= R32 with new A control
A/F	"A"= R410A with new A control
HZ	"HZ"= Hyper Heating model , "H"= Anti-freeze heater equipped model

# Refrigerant Amount

## M/S/P/Multi/Zubadan/ATW

	Model Name	Refrigerant	Pre-charged quantity			Max. added quantity	
			GWP	Weight [kg]	CO <sub>2</sub> equivalent [t]	Weight [kg]	CO <sub>2</sub> equivalent [t]
M-Series	MUZ-RW25VG	R32	675	1.20	0.81	1.40	0.95
	MUZ-RW35VG	R32	675	1.10	0.74	1.30	0.88
	MUZ-RW50VG	R32	675	1.21	0.82	1.51	1.02
	MUZ-LN25VG	R32	675	1.00	0.68	0.26	0.18
	MUZ-LN25VG2	R32	675	0.8	0.54	0.20	0.135
	MUZ-LN35VG	R32	675	1.00	0.68	0.26	0.18
	MUZ-LN35VG2	R32	675	0.85	0.57	0.20	0.14
	MUZ-LN50VG	R32	675	1.25	0.85	0.26	0.18
	MUZ-LN50VG2	R32	675	1.25	0.85	0.10	0.07
	MUZ-LN60VG	R32	675	1.45	0.98	0.46	0.32
	MUZ-LN25VGHZ	R32	675	1.00	0.68	0.26	0.18
	MUZ-LN35VGHZ	R32	675	1.00	0.68	0.26	0.18
	MUZ-LN50VGHZ	R32	675	1.45	0.98	0.46	0.32
	MUZ-FT25VGHZ	R32	675	0.85	0.58	0.25	0.17
	MUZ-FT35VGHZ	R32	675	0.95	0.65	0.45	0.31
	MUZ-FT50VGHZ	R32	675	0.95	0.65	0.45	0.31
	MUZ-AY15VG	R32	675	0.49	0.34	0.25	0.18
	MUZ-AY20VG	R32	675	0.55	0.37	0.25	0.18
	MUZ-AY25VG	R32	675	0.55	0.37	0.26	0.18
	MUZ-AY35VG	R32	675	0.55	0.37	0.26	0.18
	MUZ-AY42VG	R32	675	0.70	0.47	0.26	0.18
	MUZ-AY50VG	R32	675	1.00	0.68	0.26	0.18
	MUZ-AP60VG	R32	675	1.05	0.71	0.30	0.20
	MUZ-AP71VG	R32	675	1.50	1.02	0.30	0.20
	MUZ-AY25VGH	R32	675	0.55	0.37	0.26	0.18
	MUZ-AY35VGH	R32	675	0.55	0.37	0.26	0.18
	MUZ-AY42VGH	R32	675	0.70	0.47	0.26	0.18
	MUZ-AY50VGH	R32	675	1.00	0.68	0.26	0.18
	MUZ-EF25VGH(H)	R32	675	0.62	0.42	0.26	0.18
	MUZ-EF35VGH(H)	R32	675	0.74	0.50	0.26	0.18
	MUZ-EF42VGH	R32	675	0.74	0.50	0.26	0.18
	MUZ-EF50VGH	R32	675	1.05	0.71	0.46	0.32
	MUZ-BT20VG	R32	675	0.45	0.30	0.26	0.18
	MUZ-BT25VG	R32	675	0.50	0.34	0.26	0.18
	MUZ-BT35VG	R32	675	0.50	0.34	0.26	0.18
	MUZ-BT50VG	R32	675	0.70	0.47	0.26	0.18
	MUZ-HR25VF	R32	675	0.40	0.27	0.26	0.18
	MUZ-HR35VF	R32	675	0.45	0.30	0.26	0.18
	MUZ-HR42VF	R32	675	0.70	0.47	0.26	0.18
	MUZ-HR50VF	R32	675	0.80	0.54	0.26	0.18
	MUZ-HR60VF	R32	675	1.05	0.71	0.46	0.32
	MUZ-HR71VF	R32	675	1.05	0.71	0.46	0.32
MUZ-DW25VF	R32	675	0.50	0.34	0.25	0.17	
MUZ-DW35VF	R32	675	0.55	0.38	0.25	0.17	
MUZ-DW50VF	R32	675	0.97	0.66	0.25	0.17	
MUY-TP35VF	R32	675	0.85	0.57	0.13	0.09	
MUY-TP50VF	R32	675	0.85	0.57	0.13	0.09	
MUFZ-KW25VGHZ	R32	675	1.0	0.68	1.26	0.86	
MUFZ-KW35VGHZ	R32	675	1.0	0.68	1.26	0.86	
MUFZ-KW50VGHZ	R32	675	1.3	0.88	1.76	1.19	
MUFZ-KW60VGHZ	R32	675	1.3	0.88	1.76	1.19	
MXZ-2F32VF4	R32	675	0.8	0.54	0.8	0.54	
MXZ-2F42VF4	R32	675	1.0	0.675	1.0	0.675	
MXZ-2F53VF(H)4	R32	675	1.0	0.675	1.0	0.675	
MXZ-3F54VF4	R32	675	2.4	1.62	0	0	
MXZ-3F68VF4	R32	675	2.4	1.62	0	0	
MXZ-4F72VF4	R32	675	2.4	1.62	0	0	
MXZ-4F80VF4	R32	675	2.4	1.62	0	0	
MXZ-4F83VF2	R32	675	2.4	1.62	0	0	
MXZ-5F102VF2	R32	675	2.4	1.62	0	0	
MXZ-6F120VF2	R32	675	2.4	1.62	0	0	
MXZ-2F53VFFH2Z	R32	675	2.4	1.62	0	0	
MXZ-4F83VFFH2Z	R32	675	2.4	1.62	0	0	
MXZ-2HA40VF2	R32	675	0.9	0.61	0.9	0.61	
MXZ-2HA50VF2	R32	675	0.9	0.61	0.9	0.61	
MXZ-3HA50VF2	R32	675	1.4	0.95	1.6	1.08	

	Model Name	Refrigerant	Pre-charged quantity			Max. added quantity	
			GWP	Weight [kg]	CO <sub>2</sub> equivalent [t]	Weight [kg]	CO <sub>2</sub> equivalent [t]
S-Series	SUZ-M25VA	R32	675	0.65	0.44	0.26	0.18
	SUZ-M35VA	R32	675	0.90	0.61	0.26	0.18
	SUZ-M50VA	R32	675	1.20	0.81	0.46	0.31
	SUZ-M60VA	R32	675	1.25	0.84	0.46	0.31
	SUZ-M71VA	R32	675	1.45	0.98	0.92	0.62
P-Series	PUZ-ZM35VKA2	R32	675	2.0	1.35	0.3	0.20
	PUZ-ZM50VKA2	R32	675	2.0	1.35	0.3	0.20
	PUZ-ZM60VHA2	R32	675	2.8	1.89	0.8	0.54
	PUZ-ZM71VHA2	R32	675	2.8	1.89	0.8	0.54
	PUZ-ZM100VKA2	R32	675	3.6	2.43	2.4	1.62
	PUZ-ZM100YKA2	R32	675	3.6	2.43	2.4	1.62
	PUZ-ZM125VKA2	R32	675	3.6	2.43	2.4	1.62
	PUZ-ZM125YKA2	R32	675	3.6	2.43	2.4	1.62
	PUZ-ZM140VKA2	R32	675	3.6	2.43	2.4	1.62
	PUZ-ZM140YKA2	R32	675	3.6	2.43	2.4	1.62
	PUZ-ZM200YKA2	R32	675	6.3	4.25	9.2	6.21
	PUZ-ZM250YKA2	R32	675	6.8	4.59	9.2	6.21
	PUZ-M100VKA2	R32	675	3.1	2.1	4.8	0.7
	PUZ-M100YKA2	R32	675	3.1	2.1	1.0	0.7
	PUZ-M125VKA2	R32	675	3.6	2.4	1.0	0.95
	PUZ-M125YKA2	R32	675	3.6	2.4	1.4	0.95
	PUZ-M140VKA2	R32	675	3.6	2.4	1.4	0.95
	PUZ-M140YKA2	R32	675	3.6	2.4	1.4	0.95
	PUZ-M200YKA2	R32	675	5.6	3.78	1.4	1.08
	PUZ-M250YKA2	R32	675	6.8	4.59	1.6	1.62
PUMY	PUMY-SP112VKM2(-BS)	R410A	2088	3.5	7.31	9.0	18.79
	PUMY-SP112VKM2(-BS)	R410A	2088	3.5	7.31	9.0	18.79
	PUMY-SP125VKM2(-BS)	R410A	2088	3.5	7.31	9.0	18.79
	PUMY-SP125YKM2(-BS)	R410A	2088	3.5	7.31	9.0	18.79
	PUMY-SP140VKM2(-BS)	R410A	2088	3.5	7.31	9.0	18.79
	PUMY-SP140YKM2(-BS)	R410A	2088	3.5	7.31	9.0	18.79
	PUMY-SP140YKM2(-BS)	R410A	2088	3.5	7.31	9.0	18.79
	PUMY-SP112VKM6(-BS)	R410A	2088	4.8	10.02	13.8	28.81
	PUMY-P125VKM5(-BS)	R410A	2088	4.8	10.02	13.8	28.81
	PUMY-P140VKM5(-BS)	R410A	2088	4.8	10.02	13.8	28.81
	PUMY-P112VKM(E)5(-BS)	R410A	2088	4.8	10.02	13.8	28.81
	PUMY-P125VKM(E)6(-BS)	R410A	2088	4.8	10.02	13.8	28.81
	PUMY-P140VKM(E)5(-BS)	R410A	2088	4.8	10.02	13.8	28.81
	PUMY-P200YKM3(-BS)	R410A	2088	7.3	15.24	13.1	27.35
	PUMY-P250YBM2(-BS)	R410A	2088	9.3	19.42	32.1	67.03
PUMY-P300YBM2(-BS)	R410A	2088	9.3	19.42	32.1	67.03	
ATW Packaged	PUZ-WM50VHA	R32	675	2.0	1.35	-	-
	PUZ-WM60VAA	R32	675	2.2	1.49	-	-
	PUZ-WM85VYAA	R32	675	2.2	1.49	-	-
	PUZ-WM112VYAA	R32	675	3.0	2.03	-	-
	PUZ-HWM140V/YHA	R32	675	3.3	2.2275	-	-
	SUZ-SWM40VA	R32	675	1.2	0.81	0.4	0.27
	SUZ-SWM60VA	R32	675	1.2	0.81	0.4	0.27
	SUZ-SWM80VA	R32	675	1.2	0.81	0.4	0.27
	PUD-SWM60VAA	R32	675	1.3	0.8775	0.3	0.20
	PUD-SWM80VYAA	R32	675	1.3	0.8775	0.3	0.20
ATW Split	PUD-SWM100VYAA	R32	675	1.6	1.08	0.23	0.16
	PUD-SWM120VYAA	R32	675	1.6	1.08	0.23	0.16
	PUD-SHWM60VAA	R32	675	1.4	0.945	0.3	0.20
	PUD-SHWM80VYAA	R32	675	1.4	0.945	0.3	0.20
	PUD-SHWM100VYAA	R32	675	1.7	1.1475	0.13	0.09
	PUD-SHWM120VYAA	R32	675	1.7	1.1475	0.13	0.09
	PUD-SHWM140VYAA	R32	675	1.7	1.1475	0.13	0.09
	PUHZ-SW75VYAA	R410A	2088	3.0	6.27	1.8	3.76
	PUHZ-SW100VYAA	R410A	2088	4.2	8.77	1.6	3.76
	PUHZ-SW120V/YHA	R410A	2088	4.6	9.61	2.9	6.06
	PUHZ-SW160YKA	R410A	2088	7.1	14.83	4.0	8.36
	PUHZ-SW200YKA	R410A	2088	7.7	16.08	5.2	8.36
	PUHZ-SHW230YKA2	R410A	2088	7.1	14.83	8.4	17.54

# R32 REFRIGERANT

## R32 REFRIGERANT PROPERTIES

Under the conditions shown below, there is a possibility that R32 could ignite.

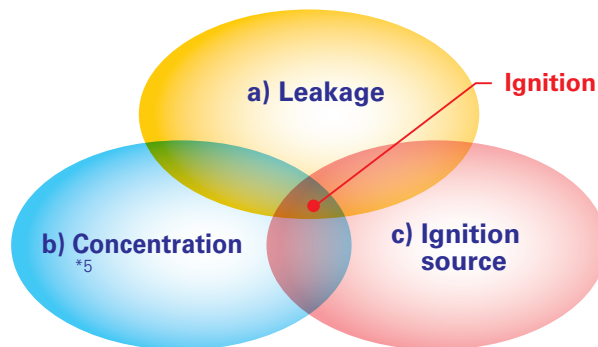

	R32	R410A	R22
Chemical formula	CH <sub>2</sub> F <sub>2</sub>	CH <sub>2</sub> F <sub>2</sub> /CHF <sub>2</sub> CF <sub>3</sub>	CHClF <sub>2</sub>
Composition (blend ratio wt. %)	Single composition	R32/R125 (50/50 wt %)	Single composition
Ozone depletion potential (ODP)	0	0	0.055
Global warming potential (GWP) *1	675	2088	1810
LFL(vol.%) *2	13.3	-	-
UFL(vol.%) *3	29.3	-	-
Flammability *4	Lower flammability (2L)	No flame propagation (1)	No flame propagation (1)

\*1 IPCC 4th assessment report.

\*2 LFL : Lower flammable limit

\*3 UFL : Upper flammable limit

\*4 ISO 817:2014

\*5 R32 consistency is higher than LFL\*1 and lower than UFL\*2.

Although R32 is classified as low flammability, the possibility of igniting can be eliminated by ensuring the following three points.

### **WARNING**

#### **a) Do not leak refrigerant.**

- <Installation> · Vacuum drying should be done. Air purging is prohibited.
- Follow "Piping Installation" on page 245.
- <Repair/Relocation/Removal> · Pump down or recovering refrigerant should be done.

#### **b) Prevent concentration.**

- Ventilate during installation and servicing, such as open the door or window and use a fan.
- Follow "Installation Restrictions" on page 260.

#### **c) Keep ignition source away from the unit.**

- Do not braze pipe and unit which contain refrigerant. Before brazing, refrigerant should be recovered.
- Do not install unit while the electricity is turned on. Turn off electricity at the fuse box and check the wiring using a tester.
- Do not smoke when working or during transportation of the product.

### **CAUTION**

Both R32 / R410A emit a toxic gas when coming into contact with an open flame.



# INSTALLATION RESTRICTIONS

In order to prevent the refrigerant from igniting, use the following instructions during installation.

## 1) Indoor Units

Install in a room with a floor area of  $A_{min}^*$  or more, corresponding to refrigerant quantity M.

(M = factory-charged refrigerant + locally added refrigerant)

Install the indoor unit so that the height from the floor to the bottom of the indoor unit is  $h_0^*$ .

\* Refer to table and drawings below.

<M Series>		<P Series> ①		<MXZ Series> ②		<Only for MFZ-KT/KW>	
M[kg]	A <sub>min</sub> [m <sup>2</sup> ]	M[kg]	A <sub>min</sub> [m <sup>2</sup> ]	M[kg]	A <sub>min</sub> [m <sup>2</sup> ]	M[kg]	A <sub>min</sub> [m <sup>2</sup> ]
0.7	1.7	1.0	4	<1.84 No requirements		1.0	3
0.8	2.0	1.5	6	1.84	6	1.5	4.5
0.9	2.2	2.0	8	2.0	6	2.0	6
1.0	2.5	2.5	10	2.5	7	2.5	7.5
1.1	2.7	3.0	12	3.0	9	3.0	9
1.2	3.0	3.5	14	3.5	10	3.5	12
1.3	3.2	4.0	16	4.0	11	4.0	15.5
1.4	3.4	4.5	20	4.5	13	4.5	20
1.5	3.7	5.0	24	5.0	14	5.0	24
1.6	3.9	5.5	29	5.5	15	5.5	29
1.7	4.2	6.0	35	6.0	17	6.0	35
1.8	4.4	6.5	41	6.5	18	6.5	41
1.9	4.6	7.0	47	7.0	20	7.0	47
2.0	4.9	7.5	54	7.5	21	7.5	54
		8.0	62	8.0	22	8.0	54
		8.5	69	8.5	24	8.5	41
		9.0	78	9.0	25	9.0	47
		9.5	87	9.5	26	9.5	54

① For wall-mounted, ceiling suspended, cassette and concealed  
② For floor-standing (PSA-M)

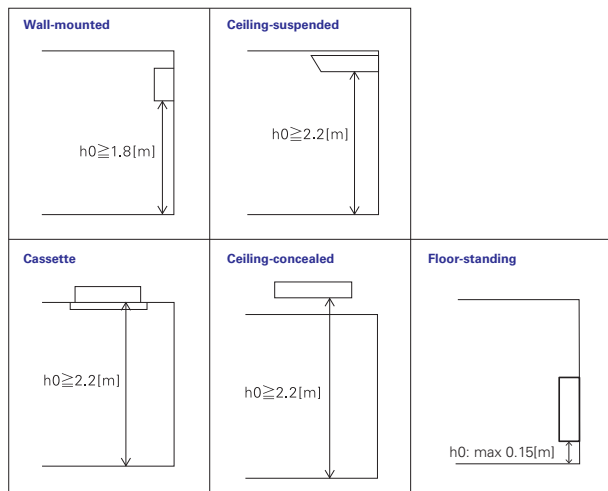

## 2) Outdoor Units

Install outdoor units in a place where at least one of the four sides is open or in a sufficiently large space without depressions.

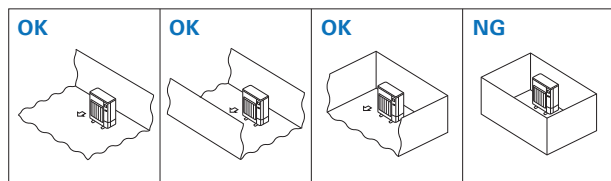

If you unavoidably install a unit in a space where all four sides are blocked or there are depressions, confirm that one of these situations (A, B or C) is satisfied.

### A Secure sufficient installation space (minimum installation area $A_{min}$ ).

Install in a space with an installation area of  $A_{min}^*$  or more, corresponding to refrigerant quantity M. (M = factory-charged refrigerant + locally added refrigerant)

\* Refer to table and drawings below.

M[kg]	A <sub>min</sub> [m <sup>2</sup> ]
1.0	12
1.5	17
2.0	23
2.5	28
3.0	34
3.5	39
4.0	45
4.5	50
5.0	56
5.5	62
6.0	67
6.5	73
7.0	78
7.5	84
8.0	89
8.5	95
9.0	100
9.5	106

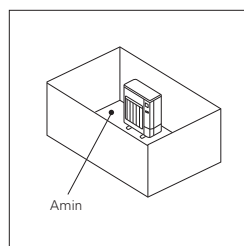

### B Install in a space with a depression height of $\leq 0.125$ [m].

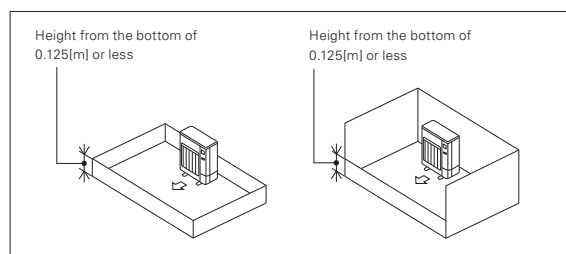

### C Create an appropriate open ventilation area.

Make sure that the width of the open area is 0.9[m] or more and the height of the open area is 0.15[m] or more.

However, the height from the bottom of the installation space to the bottom edge of the open area should be 0.125[m] or less.

More than 75% of the ventilation area should be open to allow air circulation.

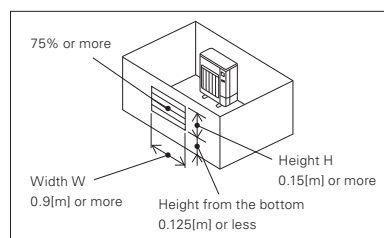

**Note** These countermeasures (A, B or C) are for keeping safety not for specification guarantee.

● Models with R32 Refrigerant: MSZ-L Series (single connection)

# LROSSNAY SYSTEM

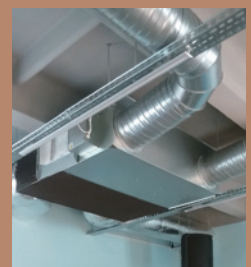







# SELECTION

LOSSNAY lineup consists of two types of ventilation: Energy Recovery Ventilation (ERV) and Heat Recovery Ventilation (HRV). Choose the model that best matches your building layout and indoor environment.

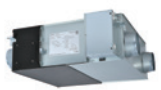
## LOSSNAY LINEUP

Application	Model	Airflow													
		50 CMH	100 CMH	150 CMH	250 CMH	350 CMH	500 CMH	650 CMH	800 CMH	1000 CMH	1500 CMH	1600 CMH	2000 CMH	2500 CMH	
Commercial	LGH-RVX3 Series			●	●	●	●	●	●	●		●	●		
	LGH-RVXT Series										●		●	●	
	LGH-RVS Series						●		●	●					
	GUF Series						●			●					
Residential	VL-CZPVU Series				●	●	●								
	VL-100(E)U5-E		●												
	VL-50(E)S2-E VL-50SR2-E	●													

## PRODUCT LINEUP

Commercial		Residential	
Ceiling Concealed Type		Vertical Type	Wall mounted Type
<p><b>LGH-RVX3 Series</b> <span style="color:red">[ERV]</span></p> <p>A commercially oriented system that can be used to deliver high performance and functions virtually anywhere.</p> 	<p><b>GUF Series</b> <span style="color:red">[ERV]</span> (LOSSNAY with Dx-Coil Unit)</p> <p>Heat recovery units with a heating and cooling system that uses the CITY MULTI outdoor units as a heat source.</p> 	<p><b>VL-CZPVU Series</b> <span style="color:green">[HRV]</span></p> <p>Vertical type for residential use. Centralized ventilation with sensible heat exchange.</p> 	<p><b>VL-100(E)U5-E</b> <span style="color:red">[ERV]</span></p> <p>Wall mounted models. Particularly suitable for houses and small offices.</p> 
<p><b>LGH-RVXT Series</b> <span style="color:red">[ERV]</span></p> <p>Thin, large airflow models of the LGH series that deliver high performance and functions.</p> 	<p><b>LGH-RVS Series</b> <span style="color:green">[HRV]</span></p> <p>Sensible heat models of the LGH series that can also be installed in sanitary areas.</p> 		<p><b>VL-50(E)S2-E</b> <span style="color:red">[ERV]</span> <b>VL-50SR2-E</b></p> <p>Wall mounted models for smaller air volumes.</p> 

\*ERV: Energy recovery ventilator \*HRV: Heat recovery ventilator

## PLASMA QUAD PROTECT LINEUP

The Plasma Quad Protect lineup includes two models to match the area that needs to be covered.

**JC-23KR-EU**  
Air purifier for large areas. Includes a HEPA filter and can be installed on the wall.



**JC-4K-EU**  
Air circulator for small areas. Can be installed on either the ceiling or wall.



# Commercial Use LOSSNAY

Mitsubishi Electric offers Energy Recovery Ventilation and Heat Recovery Ventilation solutions for optimizing building air quality by using LOSSNAY.

## Energy Recovery Ventilation

A total heat exchange ventilation system that uses paper characteristics (LOSSNAY core) to perform temperature (sensible heat) and humidity (latent heat) exchange.

### ERV Solution

Environment friendly energy recovery and humidity control enables air conditioning systems to simultaneously provide optimum room comfort and energy savings.

- ✓ Total Heat Exchanger
- ✓ Eliminates excess humidity in the air
- ✓ Wide airflow lineup

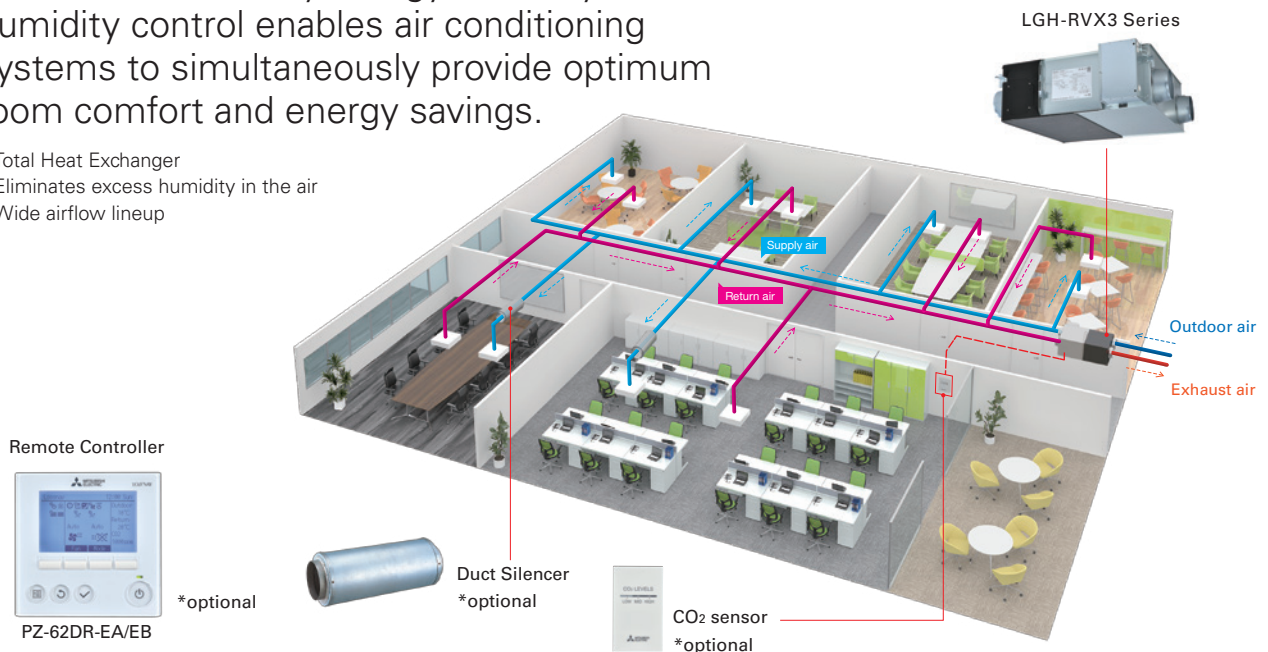

## Heat Recovery Ventilation

A heat exchange ventilation system that uses a heat exchanger (LOSSNAY core) to perform temperature (sensible heat) exchange.

### HRV Solution

Offering the best system solution for ventilation of all areas including the shower room and bathroom.

- ✓ Heat Exchanger
- ✓ Installation in sanitary areas
- ✓ CO<sub>2</sub> sensor control

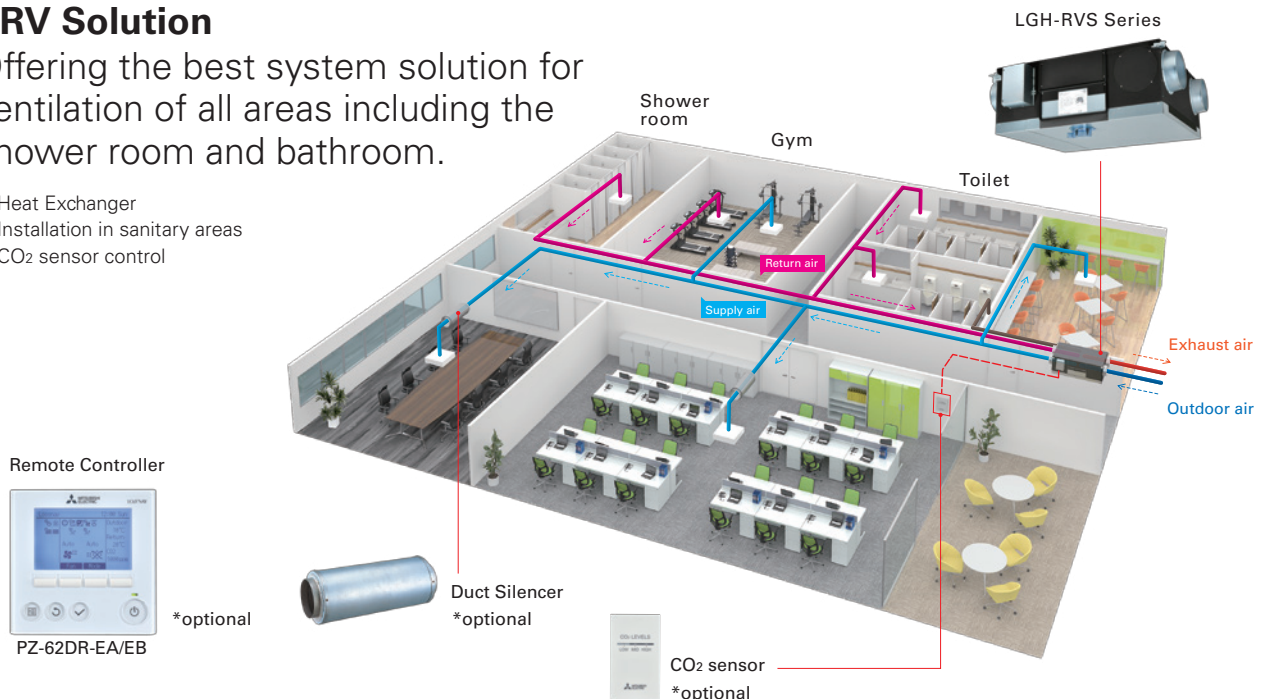

# Residential Use LOSSNAY

Mitsubishi Electric offers you decentralized ventilation and centralized ventilation solutions for optimizing your indoor air quality by using LOSSNAY.

## Heat Recovery Ventilation

A heat exchange ventilation system that uses a heat exchanger (LOSSNAY core) to perform temperature (sensible heat) exchange.

### Centralized Ventilation Solution

One LOSSNAY unit provides 24-hour ventilation for the entire house, from living room and bedrooms to the bathroom. The heat recovery system provides fresh air at a comfortable air temperature. A sensible heat exchanger effectively reduces excess humidity in the winter.

- ✓ Heat Exchanger
- ✓ Whole-house Solution
- ✓ Air Purification
- ✓ Quiet Operation
- ✓ MELCloud Control

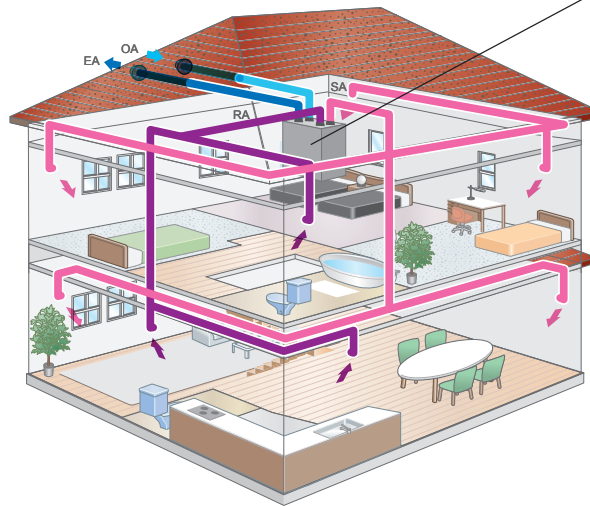

VL250/350/500CZPVU-R-E  
VL250/350/500CZPVU-L-E

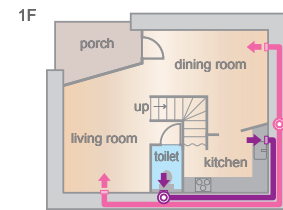
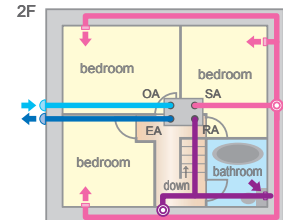

## Energy Recovery Ventilation

A total heat exchange ventilation system that uses paper characteristics (LOSSNAY Core) to perform temperature (Sensible heat) and humidity (latent heat) exchange.

### Decentralized Ventilation Solution

Install a wall-mounted LOSSNAY in each room. The heat recovery system provides fresh air at a comfortable air temperature. The total heat exchanger effectively reduces heat loss.

- ✓ Total Heat Exchanger
- ✓ Individual Ventilation
- ✓ Flexible Installation
- ✓ Easy Maintenance
- ✓ Stylish Design

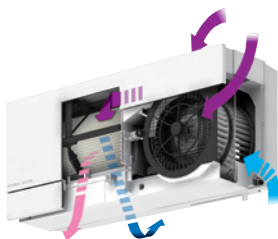

VL-100U<sub>s</sub>-E (Pull-Switch Model)  
VL-100EU<sub>s</sub>-E (Wall-Switch Model)

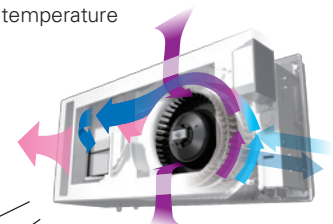
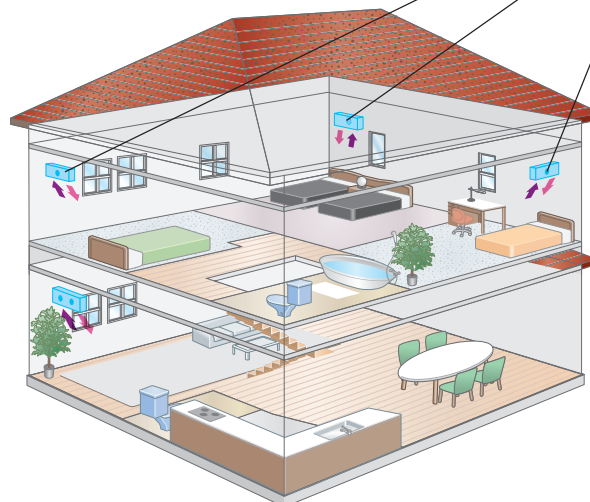

VL50S<sub>2</sub>-E (Pull-Switch Model)  
VL50ES<sub>2</sub>-E (Wall-Switch Model)  
VL50SR<sub>2</sub>-E (Remote Controller Model)

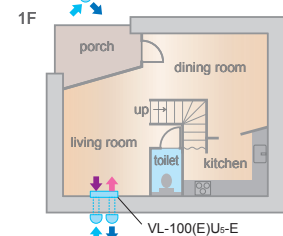
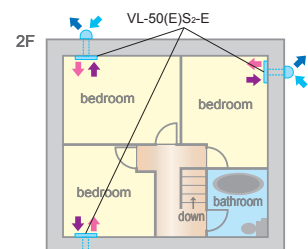

# LOSSNAY

LOSSNAY ventilation systems are renowned industry-wide for their efficiency. They offer environment-friendly energy recovery and humidity control, and enable air conditioning systems to simultaneously provide optimum room comfort and energy savings.



## Optimized Indoor Air Quality through Temperature and Humidity Exchange by LOSSNAY

LOSSNAY is a total heat exchange ventilation system that uses paper characteristics to perform temperature (sensible heat) and humidity (latent heat) exchange.

### ● The concept of sensible heat and latent heat exchange using LOSSNAY core

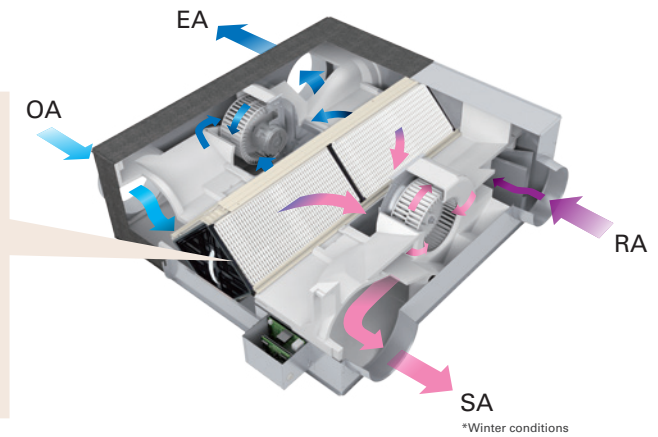
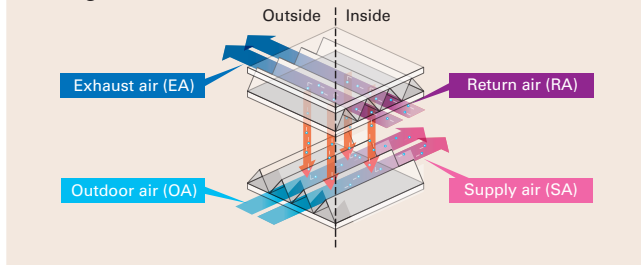

## What is Improved by Introducing LOSSNAY?

### ● Ventilation with maximized comfort

#### In summer

Air that is similar to the conditions of cooled (dehumidified) indoor air is supplied.

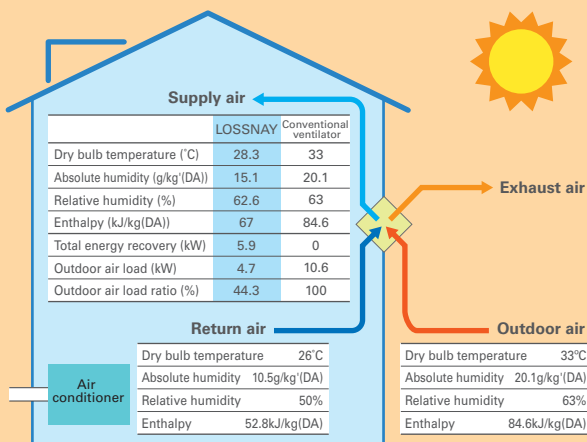

#### Heat recovery calculation

$$\text{Indoor supply air temperature (°C)} = \frac{\text{Outdoor temperature (°C)}}{\text{temperature (°C)}} \left\{ \frac{\text{Outdoor temperature (°C)} - \text{Indoor temperature (°C)}}{\text{temperature (°C)}} \right\} \times \text{Temp. recovery efficiency (\%)} + \text{Outdoor temperature (°C)}$$

Calculation example:  $28.3^{\circ}\text{C} = 33^{\circ}\text{C} - (33^{\circ}\text{C} - 26^{\circ}\text{C}) \times 67.5\%$

\*The above applies to the case of LGH-100RVX3-E. (1000m<sup>3</sup>/h)

#### In winter

Air that is similar to the conditions of heated (humidified) indoor air is supplied.

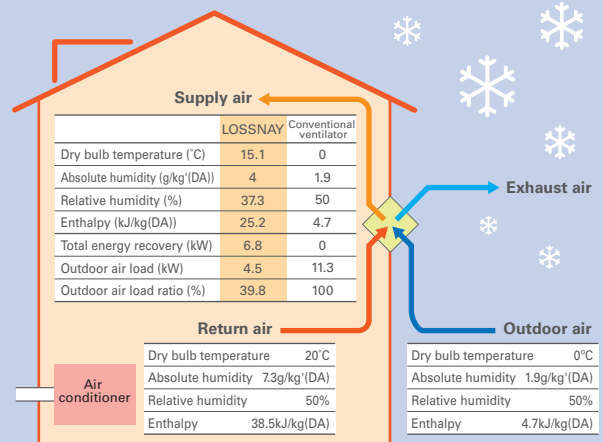

#### Heat recovery calculation

$$\text{Indoor supply air temperature (°C)} = \left\{ \frac{\text{Indoor temperature (°C)} - \text{Outdoor temperature (°C)}}{\text{temperature (°C)}} \right\} \times \text{Temp. recovery efficiency (\%)} + \text{Outdoor temperature (°C)}$$

Calculation example:  $15^{\circ}\text{C} = (20^{\circ}\text{C} - 0^{\circ}\text{C}) \times 75.5\% + 0^{\circ}\text{C}$

\*The above applies to the case of LGH-100RVX3-E. (1000m<sup>3</sup>/h)

# LGH-RVX3 SERIES

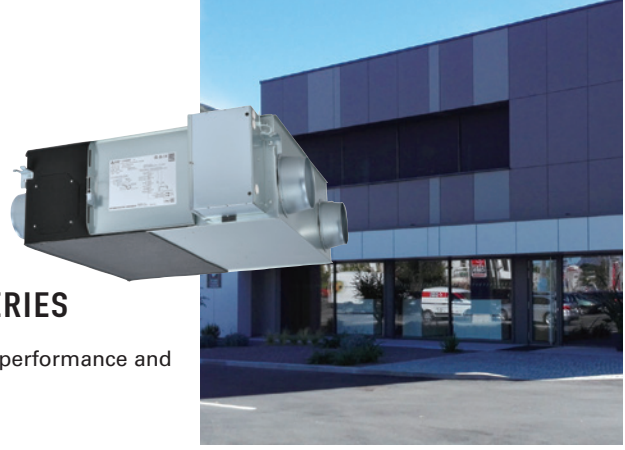

A commercially oriented system that can be used to deliver high performance and functions virtually anywhere.

LGH-15/25/35/50/65/80/100/160/200RVX3-E

## Four Key Features

### High Static Pressure

External static pressure has been improved compared to previous models. Accompanying this increase in external static pressure, the selection range of models and filters has also expanded. Furthermore, flexible duct work has become possible.

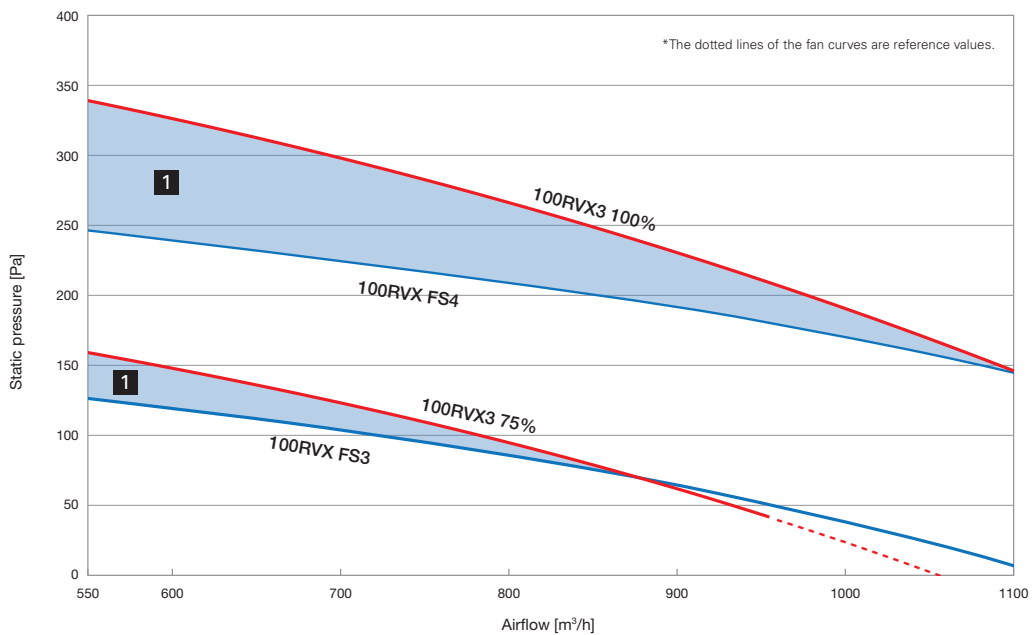

**1** Increased static pressure.

Models smaller than previous models may be chosen.

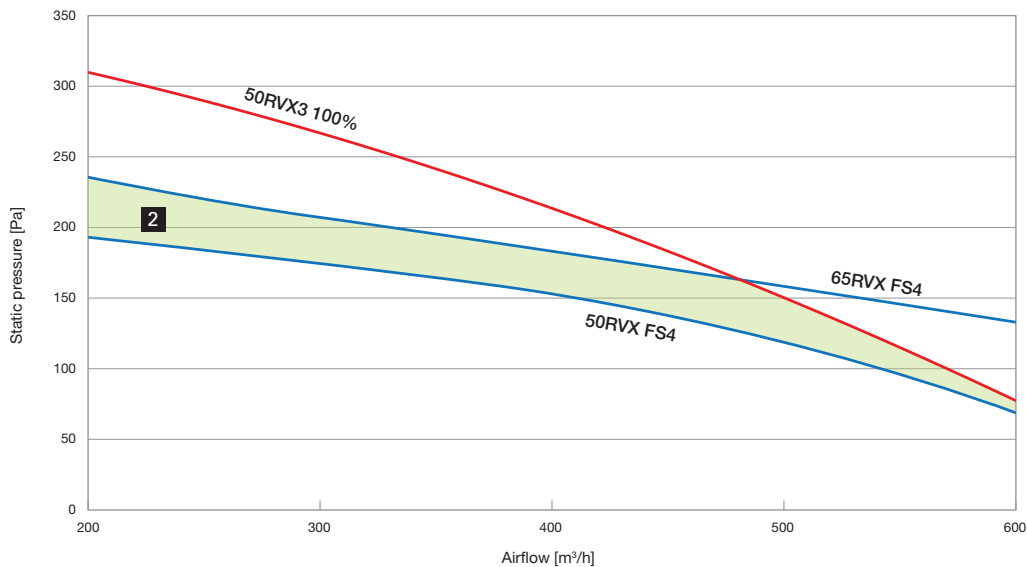

**2** Where 65RVX was previously chosen, 50RVX3 (one size down) may now be chosen, owing to its increased external static pressure.

# Controllability

## Improved airflow range

### Flexible airflow setting

The default fan speed value (Fan speed 1: 25%, Fan speed 2: 50%, Fan speed 3: 75%, and Fan speed 4: 100%) of both supply air and exhaust air can be adjusted flexibly. Within the range between 25% and 100%, airflow can be adjusted by 5% increments to satisfactorily meet the designed airflow rate.

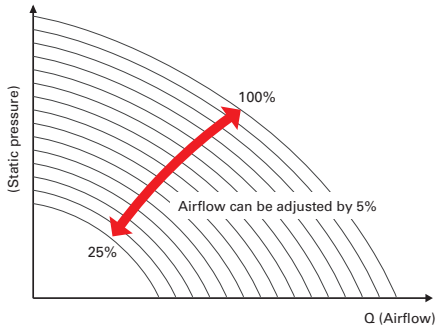

Airflow		
Add.	1	Supply / Exhaust
		30 % / 30 %
		35 % / 50 %
		75 % / 50 %
		100 % / 90 %
Speed select: ✓		
▼ Cursor ▲		



PZ-62DR-EA/EB

## CO<sub>2</sub> sensor

A CO<sub>2</sub> sensor connected directly to a LOSSNAY RVX3 unit optimizes the fan speed according to the detected CO<sub>2</sub> level. It improves total heat exchange efficiency and contributes to energy savings.

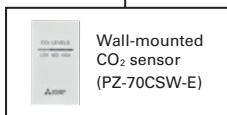

Wall-mounted CO<sub>2</sub> sensor (PZ-70CSW-E)

OR



Duct-mounted CO<sub>2</sub> sensor (PZ-70CSD-E)

Two types of CO<sub>2</sub> sensors are available: wall-mounted and duct-mounted types. Power is supplied to the CO<sub>2</sub> sensor from the LOSSNAY board.

Fan speed automatically changes from 25% to 100% (16 steps) depending on the CO<sub>2</sub> concentration level.

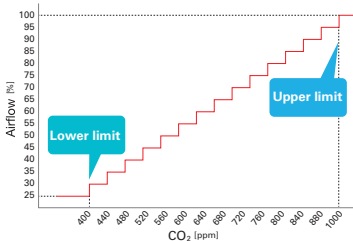

Both upper and lower limits can be adjusted. Upper limit: from 600 to 2000 ppm. Lower limit: from 300 to (upper limit - 300) ppm. 50 ppm increments.

CO <sub>2</sub> control		
▶CO <sub>2</sub> control	No	Yes
CO <sub>2</sub> upper limit	1600	ppm
CO <sub>2</sub> lower limit	450	ppm
Select: ✓		
▼ Cursor ▲		



PZ-62DR-EA/EB

### Automatic operation with CO<sub>2</sub> sensor

Fan speed automatically changes depending on CO<sub>2</sub> concentration.







## Dual Barrier Coating

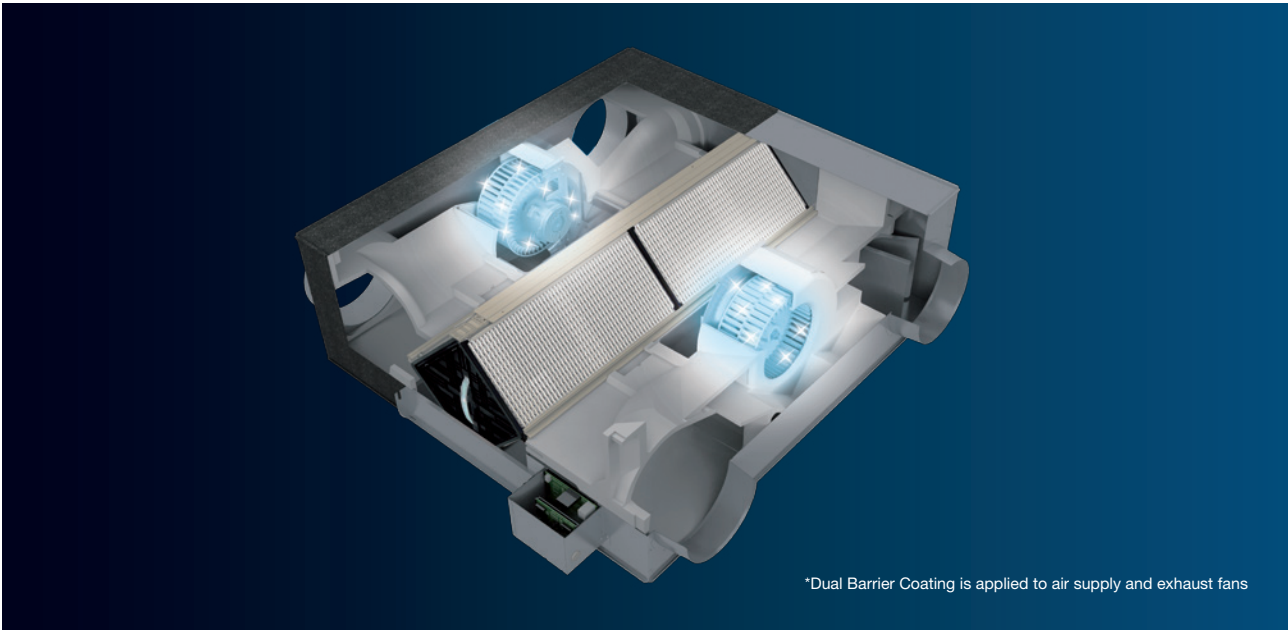

### Dual Barrier Coating

A water-repellent effect is achieved by a coating film that has nano-sized concave-convex structures formed by silica nanoparticles made of water-repellent fluororesin, in addition to micron-sized concave-convex structures formed by combining micron-sized special-shaped particles (silicate) with the silica nanoparticles. The uneven structure forms an air layer that suppresses the adhesion of dust and sand that contain a lot of humidity, and reduces the amount of dirt that adheres to the substrate.

#### ■ Conceptual image of dual barrier coating

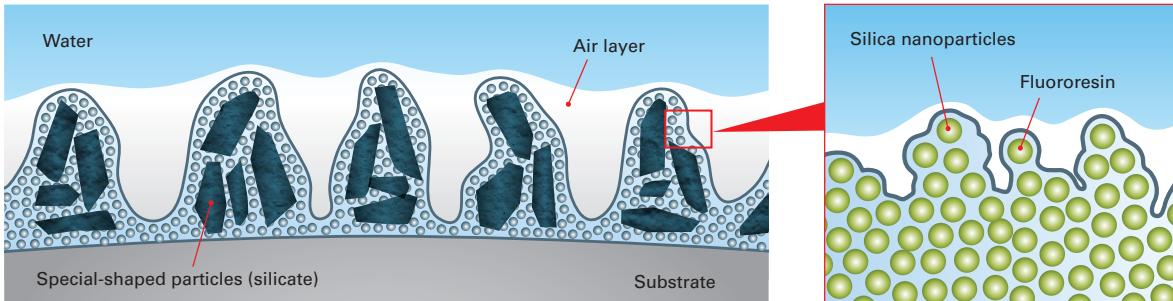

### Upgraded Filters

The replacement filter has a certification of Coarse 60% (measured by ISO16890:2016).

PZ-\*\*RF3-E  
Replacement filter



# Installation Work

## Short Commissioning Time with the New Remote Controller

New Remote Controller PZ-62DR-EA/EB, Supply and Exhaust air volume from FS1 to FS4 directly on one screen. It can also be operated while the fan motor is sensing the air volume.

By using PZ-62DR-EA/EB, the commissioning time for LGH-RVX3 is reduced by 75%\*1 compared to the previous RVX series.

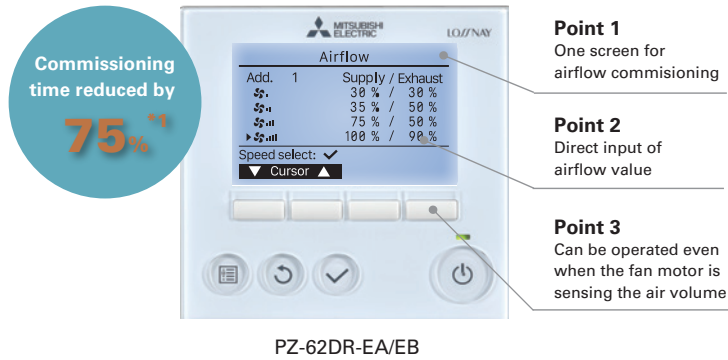

\*1: The average reduction rate when installing LGH-100RVX-E with PZ-61DR-E and LGH-100RVX3-E with PZ-62DR-EA/EB. Setting work involves changing the supply/exhaust air volume. The time that can be reduced varies depending on the operator and work conditions.

## Flexible Vertical and Horizontal Installation

For RVX3 series, vertical installation has become possible for greater flexibility of installation locations. By using optional parts, the unit can be installed in places such as the machine room where only vertical installation is possible.

**Vertical Installation Plates**

Model name	LOSSNAY
PZ-1VS-E	LGH-15RVX3-E
	LGH-25RVX3-E
	LGH-35RVX3-E
	LGH-50RVX3-E
PZ-2VS-E	LGH-65RVX3-E
	LGH-80RVX3-E
	LGH-100RVX3-E

**Horizontal installation**

**Vertical installation**

\*Not applicable to LGH-160RVX3-E and LGH-200RVX3-E.  
\*Please follow the installation manual when you install RVX3 series vertically.

# Mitsubishi Electric Ventilator Selection Tool

Mitsubishi Electric Ventilator Selection Tool is software for selecting optimal ventilation fans. In addition to supporting the selection of a sufficient model, it also provides necessary technical documents.

1) Model selection

3) Technical document archive

\*This image is for illustration purpose and actual data may vary.  
 \*Ratings and specifications may change due to product improvements or modifications.

2) Summary sheet

**1. Model selection**

An appropriate model can be selected simply by inputting the necessary air volume and static pressure. Optional parts that go with the selected model will also be listed.

**2. Summary sheet**

Data of the selected model can be downloaded by PDF file. SFP at duty, acoustic information, and energy saving calculation can be also download (varies by model).

**3. Technical document archive**

Other technical data needed for ventilation system design are also available.



Spec sheet



2D CAD



3D CAD

...and more!

## LOSSNAY YouTube Channel

LOSSNAY YouTube channel provides you videos on LOSSNAY features, structures, and more!  
 Please check the 2D code below for more details.

■RVX3 Series features



■LOSSNAY structure

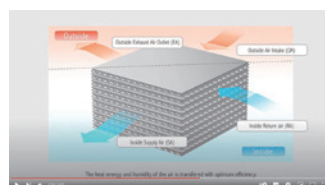

■How to select a model



# LGH-RVXT SERIES



The LGH-RVXT Series delivers a large airflow of 1500-2500 CMH with a thin body of approximately 500mm that can be easily installed in the ceiling.

LGH-150/200/250RVXT-E

## Thin Body Type

### ■ LGH-200RVX3-E



Height: 808mm

### ■ LGH-150/200/250RVXT-E



Height: 500mm

38%  
thinner  
body

### ■ LGH-RVXT installation image

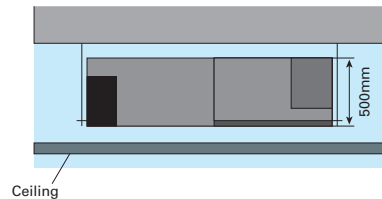

# LGH-RVS SERIES

The LGH-RVS Series of sensible heat LOSSNAY models allows diverse solutions and options in response to customer needs.

LGH-50/80/100RVS-E



## Easy Installation

### Light frame

Being frame is one of the most important factors for installation. The light frame of the LGH-RVS series provides an advantage in terms of installation cost and safety.

### Easy drain piping

- Only one drain piping for both supply air and exhaust air
- 360-degree drain pipe connection
- Trap piping work is NOT required owing to an internal backflow stopper

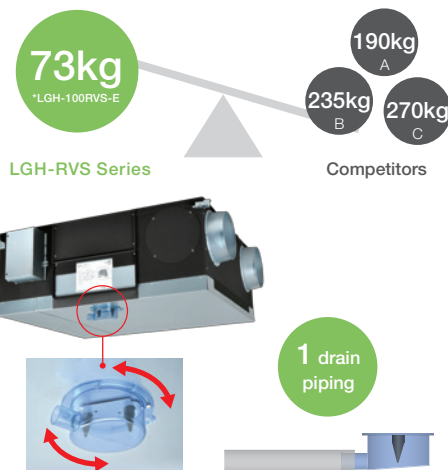

## Optional Parts

The LGH-RVS series can connect with various optional parts. A CO<sub>2</sub> sensor is one of the best solutions for optimized airflow control. The unit operates while optimizing airflow in accordance with the level of CO<sub>2</sub> concentration in the room. Optimized ventilation can reduce the energy consumption of the air conditioner. A high-efficiency filter can be optionally installed in the unit as an easy solution for even better indoor air quality.

### ■ CO<sub>2</sub> sensor



### ■ Filter



### ■ Duct Silencer



# GUF SERIES

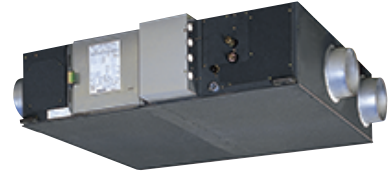

Along with LOSSNAY ventilation, the OA processing unit is really two units in one, functioning as the main air conditioner when the load is light and adding supplemental air conditioning when the load is heavy.

GUF-50/100RD4

GUF-50/100RDH4 Small stock

These units can be used with R410A.

Outdoor units are available for the GUF-RD/RDH series (for details see Mitsubishi Electric's CITY MULTI catalog).

## R410A Refrigerant Units

Model Size		P112	P125	P140	P200	P250	P300	P350	P400	P450	P500	P550	P600	P650	P700	P750	P800
Y Series	PUHY-YGM-A				●	●	●	●	●	●	●	●	●	●	●	●	●
R2 Series	PURY-YGM-A				●	●	●	●	●	●	●	●	●	●			
PUMY Series	PUMY-SP	●	●	●													
	PUMY-P	●	●	●	●												

## LOSSNAY Ventilation and Air Conditioning

The OA (outdoor air) Processing Unit creates an optimum environment while providing substantial energy savings. It delivers forced air ventilation, heat recovery, heating and cooling, and air purification. This total air conditioning system keeps indoor air fresh and comfortable all year round, and keeps it free of contaminants that could cause ailments such as sick building syndrome. Inside the OA Processing Unit is the LOSSNAY core, a heat exchange unit that transfers heat efficiently, and cuts ventilation load by as much as 70%. A remarkable product found nowhere else, this special combination of functionality and performance contained within a single unit ensures users ample comfort, good health, and energy savings.

### GUF-RD type

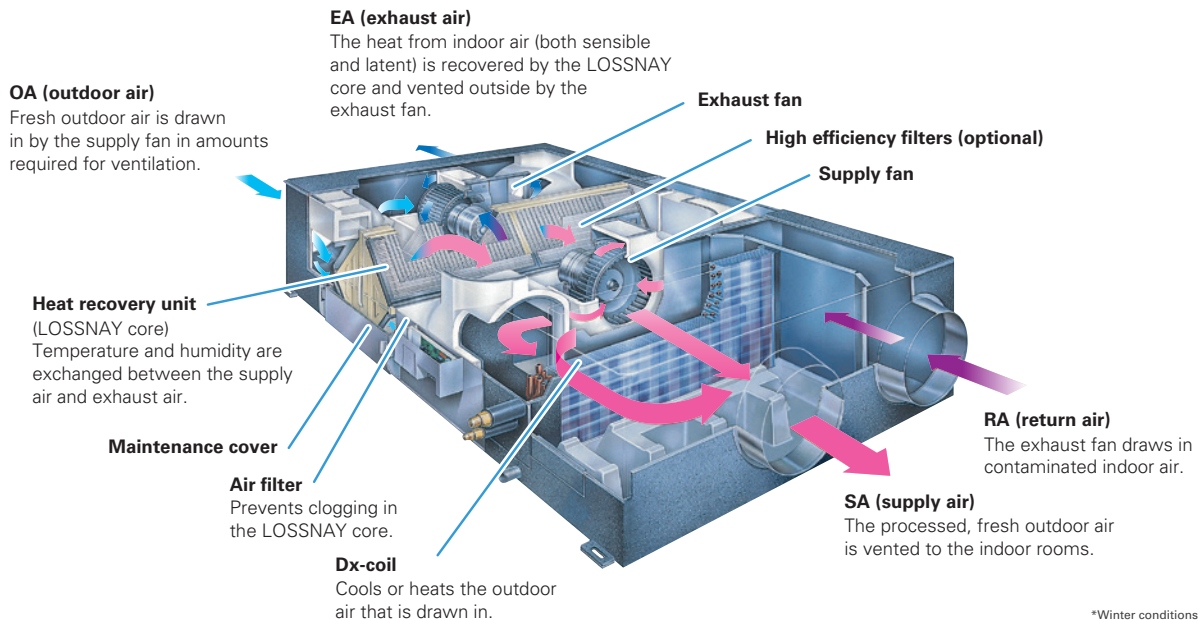

# LGH-RVX3 SERIES

## Specifications

### LGH-15RVX3-E

Electrical power supply	220-240V/50Hz, 220V/60Hz				Test condition	
Fan speed	4	3	2	1		
Default airflow setting	100%	75%	50%	25%		
Input power (W)	55	30	15	10		
Airflow	(m <sup>3</sup> /h)	150	113	75		38
	(L/s)	42	31	21		10
Specific fan power [W/(L/s)]	1.32	0.96	0.72	0.96		
External static pressure (Pa)	120	68	30	8		
Temperature exchange efficiency (%)	Heating	73.5	75.5	78.0		81.5
	Cooling	65.5	70.5	73.5		78.0
Enthalpy exchange efficiency (%)	Heating	70.5	73.5	76.5	80.5	
	Cooling	58.0	62.0	66.0	73.0	
Noise (dB) <small>(Measured at 1.5m under the center of the unit in an anechoic chamber)</small>	27.0	22.0	18.0	17.0	A-weighted sound pressure level	
Exhaust air transfer ratio (%)	5.0				EN308: 2022/FS3	
Weight (kg)	20					

### Characteristic Curves

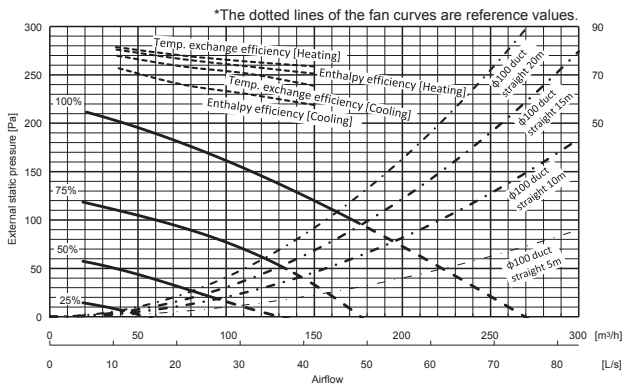

### Dimensions

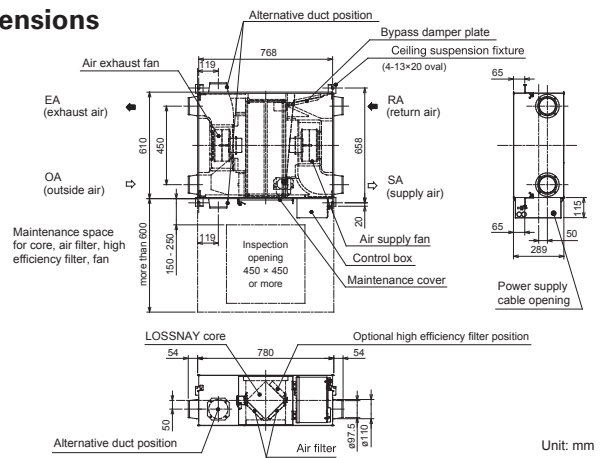

### LGH-25RVX3-E

Electrical power supply	220-240V/50Hz, 220V/60Hz				Test condition	
Fan speed	4	3	2	1		
Default airflow setting	100%	75%	50%	25%		
Input power (W)	75	42	21	11		
Airflow	(m <sup>3</sup> /h)	250	188	125		63
	(L/s)	69	52	35		17
Specific fan power [W/(L/s)]	1.08	0.81	0.60	0.63		
External static pressure (Pa)	120	68	30	8		
Temperature exchange efficiency (%)	Heating	75.5	78.5	81.0		88.0
	Cooling	70.5	76.5	79.0		85.0
Enthalpy exchange efficiency (%)	Heating	69.0	72.0	75.5	84.0	
	Cooling	59.0	63.5	68.0	75.0	
Noise (dB) <small>(Measured at 1.5m under the center of the unit in an anechoic chamber)</small>	30.5	25.0	19.5	17.0	A-weighted sound pressure level	
Exhaust air transfer ratio (%)	5.0				EN308: 2022/FS3	
Weight (kg)	22					

### Characteristic Curves

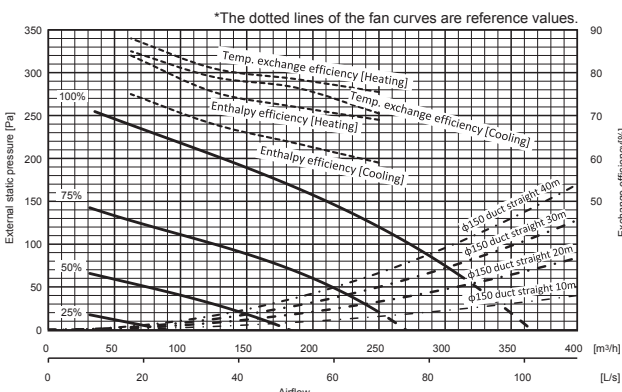

### Dimensions

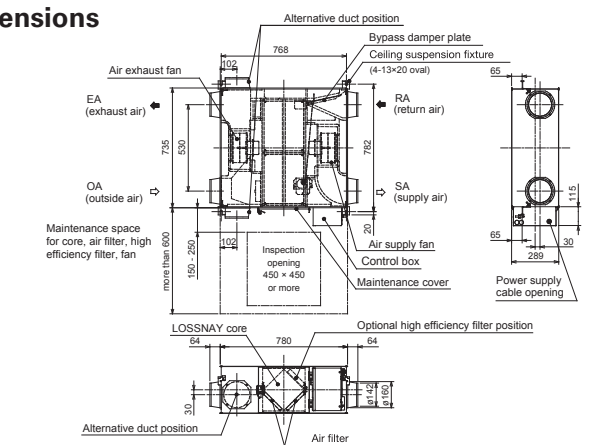

■ For LGH-RVX3 series

\*The input power, the efficiency and the noise are based on the rating air volume, 230V/50Hz and horizontal installation.

\*Specifications may be subject to change without notice.

## LGH-35RVX3-E

Electrical power supply	220-240V/50Hz, 220V/60Hz				Test condition	
Fan speed	4	3	2	1		
Default airflow setting	100%	75%	50%	25%		
Input power (W)	120	61	29	15		
Airflow	(m <sup>3</sup> /h)	350	263	175		88
	(L/s)	97	73	49		24
Specific fan power [W/(L/s)]	1.23	0.84	0.60	0.62		
External static pressure (Pa)	160	90	40	10		
Temperature exchange efficiency (%)	Heating	75.0	77.0	79.0		82.0
	Cooling	66.5	71.0	74.0		79.0
Enthalpy exchange efficiency (%)	Heating	72.0	74.5	77.5	80.0	
	Cooling	60.0	64.5	68.5	74.5	
Noise (dB) <small>(Measured at 1.5m under the center of the unit in an anechoic chamber)</small>	30.5	24.5	19.0	17.0	A-weighted sound pressure level	
Exhaust air transfer ratio (%)	5.0				EN308: 2022/FS3	
Weight (kg)	30					

## Characteristic Curves

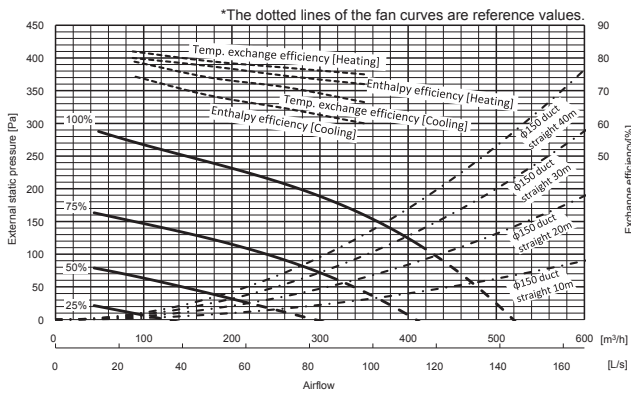

## Dimensions

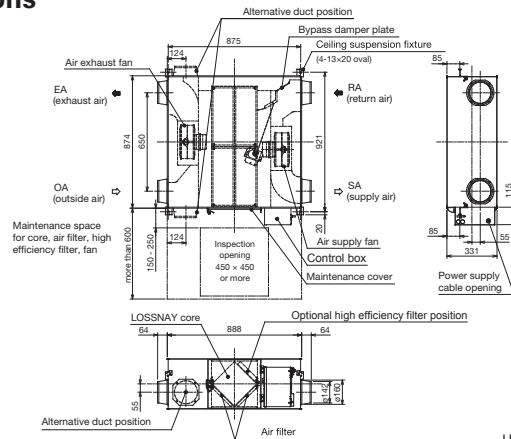

## LGH-50RVX3-E

Electrical power supply	220-240V/50Hz, 220V/60Hz				Test condition	
Fan speed	4	3	2	1		
Default airflow setting	100%	75%	50%	25%		
Input power (W)	185	81	34	15		
Airflow	(m <sup>3</sup> /h)	500	375	250		125
	(L/s)	139	104	69		35
Specific fan power [W/(L/s)]	1.33	0.78	0.49	0.43		
External static pressure (Pa)	150	85	38	10		
Temperature exchange efficiency (%)	Heating	70.5	71.5	73.5		75.0
	Cooling	63.5	67.0	71.0		73.0
Enthalpy exchange efficiency (%)	Heating	68.5	69.5	72.0	73.0	
	Cooling	53.5	58.0	63.0	68.0	
Noise (dB) <small>(Measured at 1.5m under the center of the unit in an anechoic chamber)</small>	35.0	27.0	21.0	17.0	A-weighted sound pressure level	
Exhaust air transfer ratio (%)	5.0				EN308: 2022/FS3	
Weight (kg)	33					

## Characteristic Curves

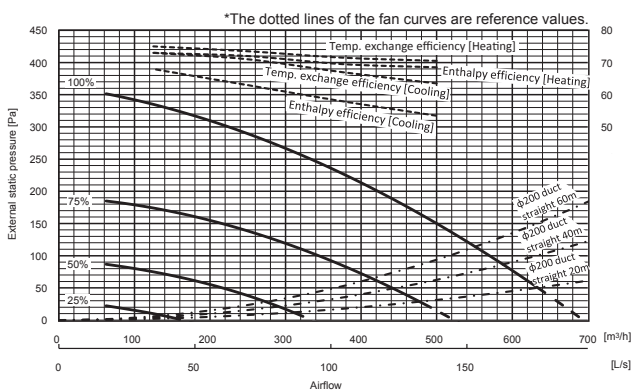

## Dimensions

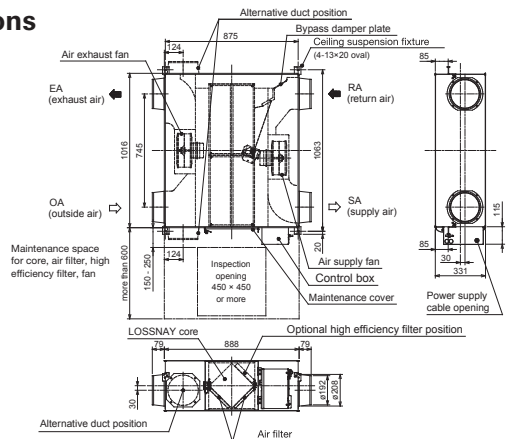

■ For LGH-RVX3 series

\*The input power, the efficiency and the noise are based on the rating air volume, 230V/50Hz and horizontal installation.

\*Specifications may be subject to change without notice.

## LGH-65RVX3-E

Electrical power supply	220-240V/50Hz, 220V/60Hz				Test condition	
Fan speed	4	3	2	1		
Default airflow setting	100%	75%	50%	25%	EN13053: 2019	
Input power (W)	245	120	51	20		
Airflow	(m <sup>3</sup> /h)	650	488	325		163
	(L/s)	181	135	90		45
Specific fan power [W/(L/s)]	1.36	0.89	0.56	0.44	EN308: 2022	
External static pressure (Pa)	150	85	38	10		
Temperature exchange efficiency (%)	Heating	72.5	75.0	78.5		82.0
	Cooling	65.0	70.0	74.5		80.0
Enthalpy exchange efficiency (%)	Heating	69.5	72.0	76.5	80.0	
	Cooling	55.5	60.0	66.5	74.0	
Noise (dB) <small>(Measured at 1.5m under the center of the unit in an anechoic chamber)</small>	37.5	31.5	24.0	17.5	A-weighted sound pressure level	
Exhaust air transfer ratio (%)	5.0					EN308: 2022/FS3
Weight (kg)					41	

## Characteristic Curves

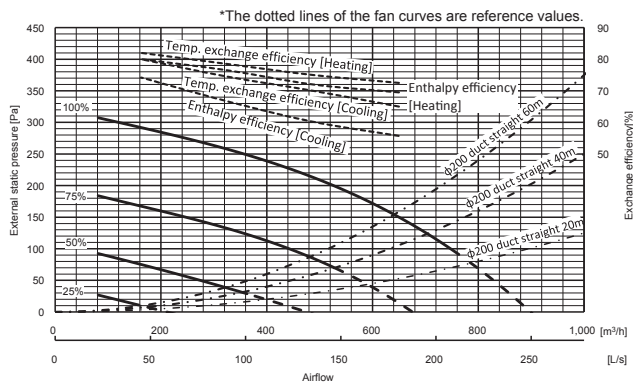

## Dimensions

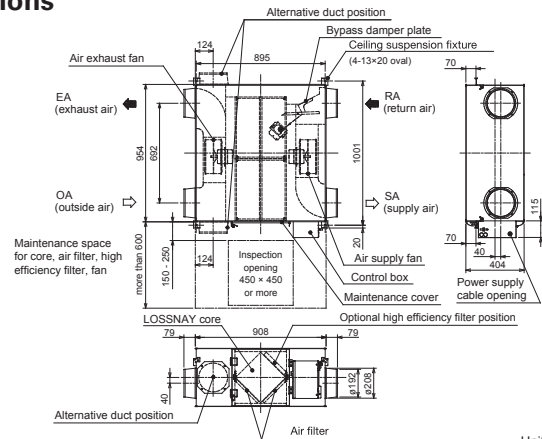

## LGH-80RVX3-E

Electrical power supply	220-240V/50Hz, 220V/60Hz				Test condition	
Fan speed	4	3	2	1		
Default airflow setting	100%	75%	50%	25%	EN13053: 2019	
Input power (W)	343	160	64	23		
Airflow	(m <sup>3</sup> /h)	800	600	400		200
	(L/s)	222	167	111		56
Specific fan power [W/(L/s)]	1.54	0.96	0.58	0.41	EN308: 2022	
External static pressure (Pa)	170	96	43	11		
Temperature exchange efficiency (%)	Heating	75.0	76.5	78.0		80.0
	Cooling	65.0	70.0	75.5		78.0
Enthalpy exchange efficiency (%)	Heating	62.0	65.0	70.5	73.5	
	Cooling	54.5	58.5	65.0	70.5	
Noise (dB) <small>(Measured at 1.5m under the center of the unit in an anechoic chamber)</small>	39.0	33.5	25.0	18.0	A-weighted sound pressure level	
Exhaust air transfer ratio (%)	5.0					EN308: 2022/FS3
Weight (kg)					47	

## Characteristic Curves

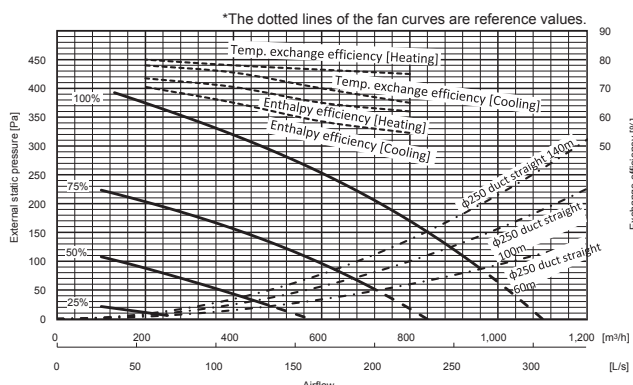

## Dimensions

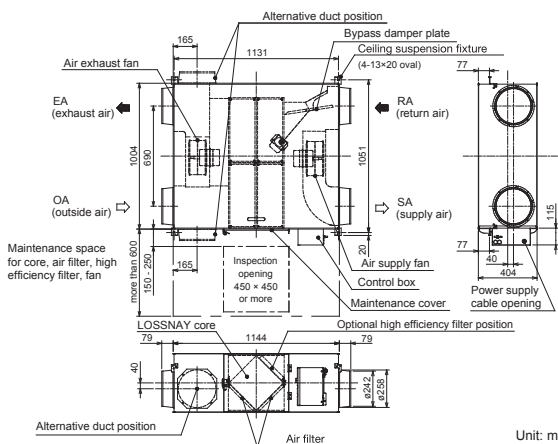

■ For LGH-RVX3 series

\*The input power, the efficiency and the noise are based on the rating air volume, 230V/50Hz and horizontal installation.

\*Specifications may be subject to change without notice.





## LGH-200RVX3-E

Electrical power supply	220-240V/50Hz, 220V/60Hz				Test condition			
Fan speed	4	3	2	1				
Default airflow setting	100%	75%	50%	25%	EN13053: 2019			
Input power (W)	855	416	163	57				
Airflow	(m <sup>3</sup> /h)	2000	1500	1000	500	EN308: 2022		
	(L/s)	556	417	278	139			
Specific fan power [W/(L/s)]	1.54				1.00	0.59	0.41	
External static pressure (Pa)	170				96	43	11	
Temperature exchange efficiency (%)	Heating	76.5	77.5	79.5	83.5	EN308: 2022		
	Cooling	66.5	71.5	76.0	82.5			
Enthalpy exchange efficiency (%)	Heating	60.5	64.0	67.5	76.0	EN308: 2022		
	Cooling	57.0	60.0	65.0	71.0			
Noise (dB) (Measured at 1.5m under the center of the unit in an anechoic chamber)	41.5				36.0	27.5	18.0	A-weighted sound pressure level
Exhaust air transfer ratio (%)					5.0	108		EN308: 2022/FS3
Weight (kg)								108

## Characteristic Curves

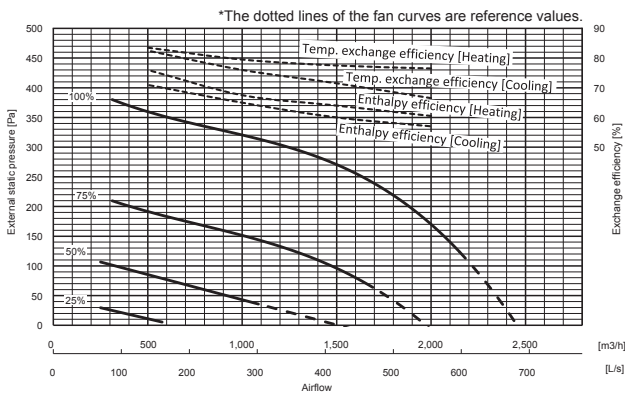

## Dimensions

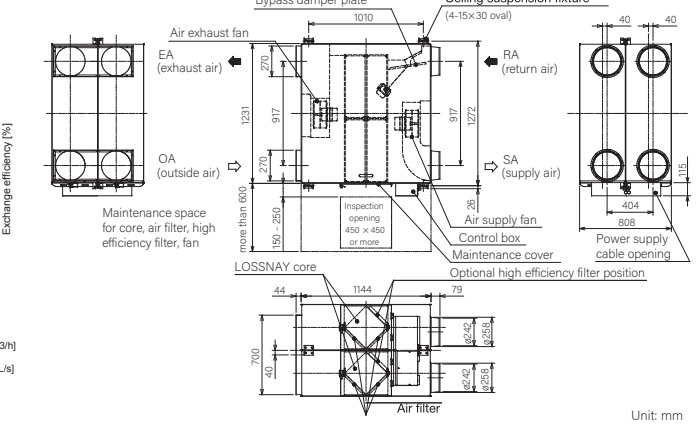

## LGH-RVXT SERIES

### Specifications

### LGH-150RVXT-E

Electrical power supply	220-240V/50Hz, 220V/60Hz								
Ventilation mode	Heat recovery mode				Bypass mode				
Fan speed	SP4	SP3	SP2	SP1	SP4	SP3	SP2	SP1	
Running current (A)	4.30	2.40	1.10	0.36	3.40	1.80	0.77	0.31	
Input power (W)	792	421	176	48	625	334	134	37	
Airflow	(m <sup>3</sup> /h)	1500	1125	750	375	1500	1125	750	375
	(L/s)	417	313	208	104	417	313	208	104
External static pressure (Pa)	Supply	175	98	44	11	175	98	44	11
	Return	100	56	25	6	100	56	25	6
Temperature exchange efficiency (%)	80	80.5	81	81.5	-	-	-	-	
Enthalpy exchange efficiency (%)	Heating	70	71	73	75	-	-	-	
	Cooling	69	70	72	74	-	-	-	
Noise (dB) (Measured at 1.5m under the center of the unit in an anechoic chamber)	39.5	35.5	29.5	22	39	33	26.5	20.5	
Weight (kg)	156								

## Characteristic Curves

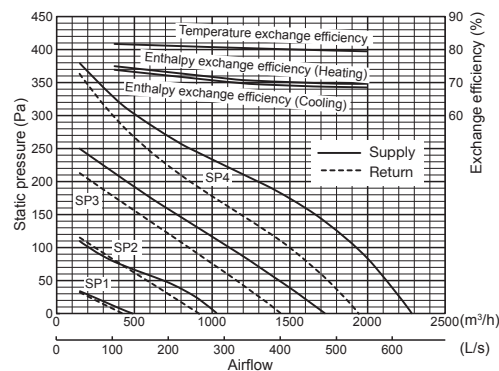

## Dimensions

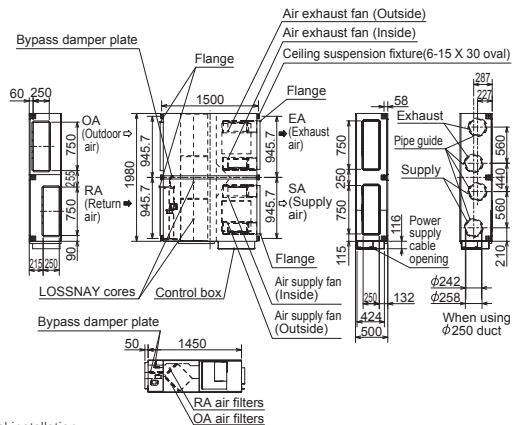

- For LGH-RVX3 series
- \* The input power, the efficiency and the noise are based on the rating air volume, 230V/50Hz and horizontal installation.
- For LGH-RVXT series
- \* The running current, the input power, the efficiency and the noise are based on the rated airflow, 230V/50Hz.
- \* Figures in the chart is measured according to Japan Industrial Standard (JIS B 8628). Characteristic Curves are measured by chamber method.
- \* Specifications may be subject to change without notice.

Unit: mm

## LGH-200RVXT-E

Electrical power supply	220-240V/50Hz, 220V/60Hz								
Ventilation mode	Heat recovery mode				Bypass mode				
Fan speed	SP4	SP3	SP2	SP1	SP4	SP3	SP2	SP1	
Running current (A)	5.40	2.70	1.10	0.39	5.00	2.20	0.85	0.34	
Input power (W)	1000	494	197	56	916	407	150	45	
Airflow	(m <sup>3</sup> /h)	2000	1500	1000	500	2000	1500	1000	500
	(L/s)	556	417	278	139	556	417	278	139
External static pressure (Pa)	Supply	175	98	44	11	175	98	44	11
	Return	100	56	25	6	100	56	25	6
Temperature exchange efficiency (%)		80	81	82.5	84	-	-	-	-
Enthalpy exchange efficiency (%)	Heating	72.5	73.5	77	83	-	-	-	-
	Cooling	70	71	74.5	80.5	-	-	-	-
Noise (dB) (Measured at 1.5m under the center of the unit in an anechoic chamber)		39.5	35.5	28	22	40.5	34.5	27	20.5
Weight (kg)	159								

## Characteristic Curves

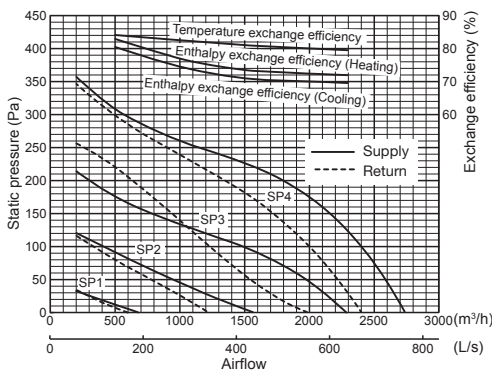

## Dimensions

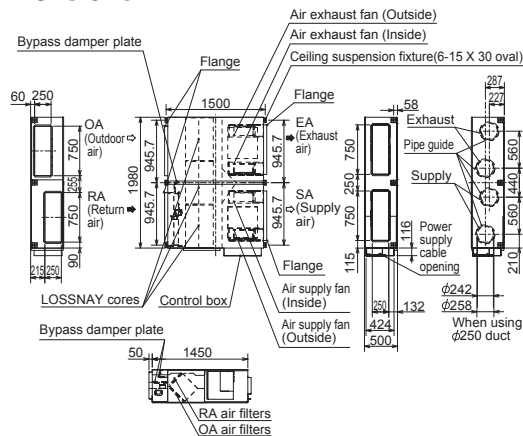

Unit: mm

## LGH-250RVXT-E

Electrical power supply	220-240V/50Hz, 220V/60Hz								
Ventilation mode	Heat recovery mode				Bypass mode				
Fan speed	SP4	SP3	SP2	SP1	SP4	SP3	SP2	SP1	
Running current (A)	7.60	3.60	1.40	0.57	6.90	3.10	1.30	0.49	
Input power (W)	1446	687	244	82	1298	587	212	69	
Airflow	(m <sup>3</sup> /h)	2500	1875	1250	625	2500	1875	1250	625
	(L/s)	694	521	347	174	694	521	347	174
External static pressure (Pa)	Supply	175	98	44	11	175	98	44	11
	Return	100	56	25	6	100	56	25	6
Temperature exchange efficiency (%)		77	79	80.5	82.5	-	-	-	-
Enthalpy exchange efficiency (%)	Heating	68	71.5	74	79	-	-	-	-
	Cooling	65.5	69	71.5	76.5	-	-	-	-
Noise (dB) (Measured at 1.5m under the center of the unit in an anechoic chamber)		43	39	32	24	44	38.5	31	22.5
Weight (kg)	198								

## Characteristic Curves

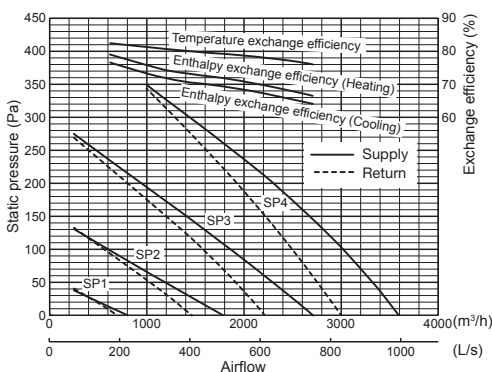

## Dimensions

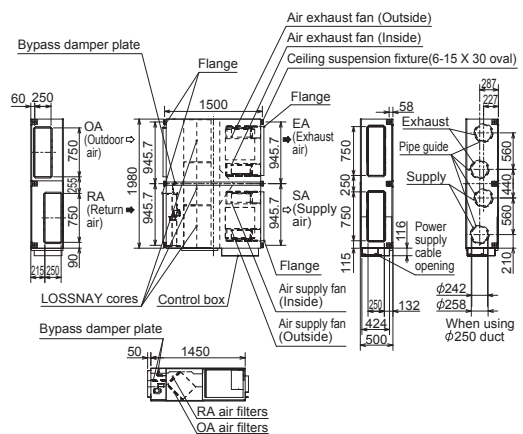

Unit: mm

■ For LGH-RVXT series

\*The running current, the input power, the efficiency and the noise are based on the rated airflow, 230V/50Hz.

\*Figures in the chart is measured according to Japan Industrial Standard (JIS B 8628). Characteristic Curves are measured by chamber method.

\*Specifications may be subject to change without notice.

# LGH-RVS SERIES

## Specifications

### LGH-50RVS-E

Weight	55kg (67kg with maximum drain water)				
Electrical power supply	220-240V/50Hz, 220V/60Hz				
Fan speed	100%	75%	50%	25%	Test condition
Input power (W)	190	110	60	25	
Airflow	(m <sup>3</sup> /h)	500	375	250	ISO 16494
	(L/s)	139	104	69	
Specific fan power [W/(L/s)]	1.37	1.06	0.86	0.72	Temp. exchange efficiency is winter condition
External static pressure (Pa)	150	84	38	9	
Temperature exchange efficiency (%)	87.0	89.0	91.0	93.0	A-weighted sound pressure level @1.5m off from the center of the unit in an anechoic chamber
Noise (dB)	33.0	27.0	22.0	18.0	
Exhaust air transfer ratio (%)	5				Tracer gas method @100% airflow (EN308)

### Characteristic Curves

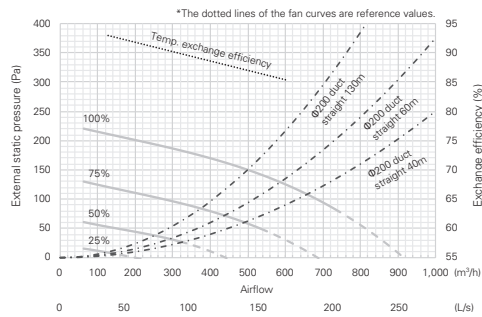

### Dimensions

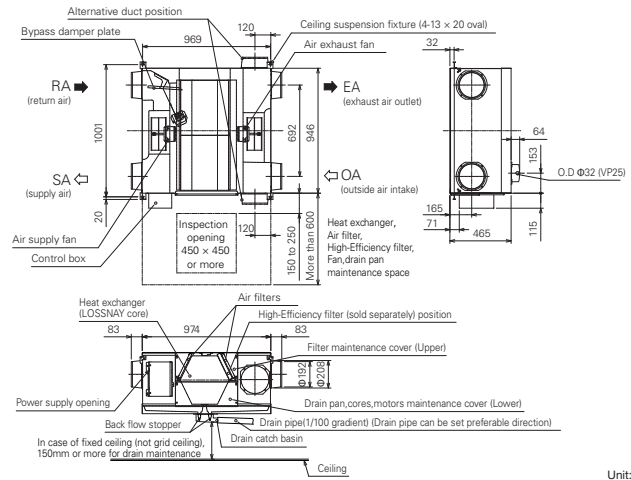

### LGH-80RVS-E

Weight	63kg (77kg with maximum drain water)				
Electrical power supply	220-240V/50Hz, 220V/60Hz				
Fan speed	100%	75%	50%	25%	Test condition
Input power (W)	325	175	85	32	
Airflow	(m <sup>3</sup> /h)	800	600	400	ISO 16494
	(L/s)	222	167	111	
Specific fan power [W/(L/s)]	1.46	1.05	0.77	0.58	Temp. exchange efficiency is winter condition
External static pressure (Pa)	170	96	43	11	
Temperature exchange efficiency (%)	82.0	84.0	86.0	90.0	A-weighted sound pressure level @1.5m off from the center of the unit in an anechoic chamber
Noise (dB)	36.0	30.0	25.0	18.0	
Exhaust air transfer ratio (%)	5				Tracer gas method @100% airflow (EN308)

### Characteristic Curves

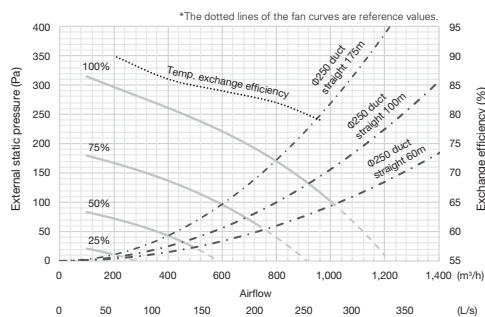

### Dimensions

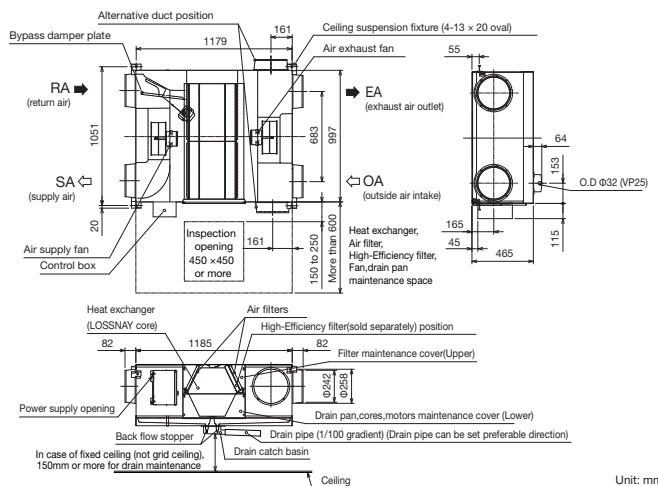

■The input power, the efficiency and the noise are based on the rating airflow, and 230V/50Hz. Temperature exchange efficiency (%) is measured at indoor DB 20°C/WB15°C and outdoor DB 5°C/WB3°C. It is measured according to ISO16494.  
 When the indoor humidity is low and condensation in the heat exchanger does not occur, the exchange efficiency may be decreased in winter.  
 ■The absolute humidity of RA shall be lower than 0.0139kg/kg (DA) in winter and relative humidity of RA shall be lower than 90%RH through the year.  
 Example of the absolute humidity 0.0139kg/kg (DA) are 20.7°C 90%RH, 25°C 70%, 30°C 50% etc.  
 ■Specifications may be subject to change without notice.

## LGH-100RVS-E

Weight	73kg (89kg with maximum drain water)					
Electrical power supply	220-240V/50Hz, 220V/60Hz					
Fan speed	100%	75%	50%	25%	Test condition	
Input power (W)	445	225	100	35		
Airflow	(m <sup>3</sup> /h)	1000	750	500	250	ISO 16494 Temp. exchange efficiency is winter condition
	(L/s)	278	208	139	69	
Specific fan power [W/(L/s)]	1.60	1.08	0.72	0.50		
External static pressure (Pa)	190	107	48	12		
Temperature exchange efficiency (%)	82.0	84.0	86.0	90.0		
Noise (dB)	37.0	32.0	24.0	18.0	A-weighted sound pressure level @1.5m off from the center of the unit in an anechoic chamber	
Exhaust air transfer ratio (%)	5				Tracer gas method @100% airflow (EN308)	

## Characteristic Curves

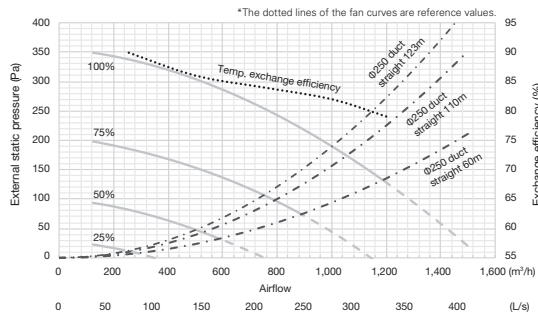

## Dimensions

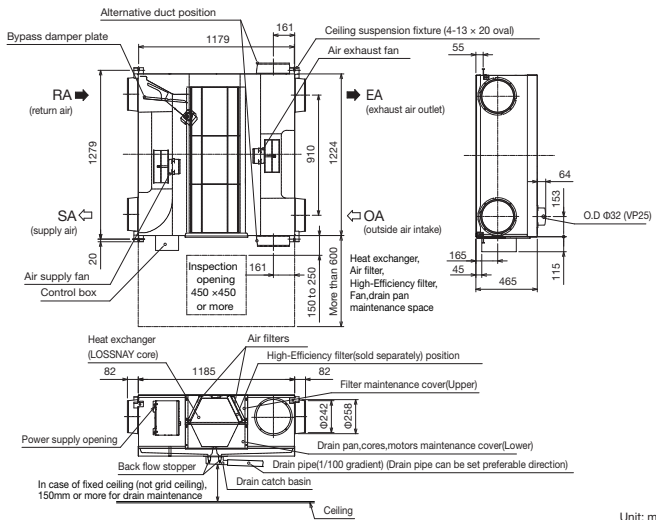

Unit: mm

- The input power, the efficiency and the noise are based on the rating airflow, and 230V/50Hz. Temperature exchange efficiency (%) is measured at indoor DB 20°C/WB15°C and outdoor DB 5°C/WB3°C. It is measured according to ISO16494.
- When the indoor humidity is low and condensation in the heat exchanger does not occur, the exchange efficiency may be decreased in winter.
- The absolute humidity of RA shall be lower than 0.0139kg/kg (DA) in winter and relative humidity of RA shall be lower than 90%RH through the year.
- Example of the absolute humidity 0.0139kg/kg (DA) are 20.7°C 90%RH, 25°C 70%, 30°C 50% etc.
- Specifications may be subject to change without notice.

# GUF SERIES

## Specifications

### GUF-50RD4

Electrical power supply		220-240V/50Hz			
		Heat recovery mode		Bypass mode	
Ventilation mode					
Fan speed		High	Low	High	Low
Running current (A)		1.15	0.70	1.15	0.70
Input power (W)		235-265	150-165	235-265	150-165
Airflow	(m <sup>3</sup> /h)	500	400	500	400
	(L/s)	139	111	139	111
External static pressure (Pa)		140	90	140	90
Temperature exchange efficiency (%)		77.5	80	-	-
Enthalpy exchange efficiency (%)	Heating	68	71	-	-
	Cooling	65	67	-	-
Cooling capacity (kW)		5.57 (1.94)			
Heating capacity (kW)		6.21 (2.04)			
Capacity equivalent to the indoor unit		P32			
Humidifier	Humidifying	-			
	Humidifying capacity (kg/h)	-			
	Water supply pressure	-			
Noise (dB) (Measured at 1.5m under the center of the unit in an anechoic chamber)		33.5-34.5	29.5-30.5	35-36	29.5-30.5
Weight (kg)		48			

### Characteristic Curves

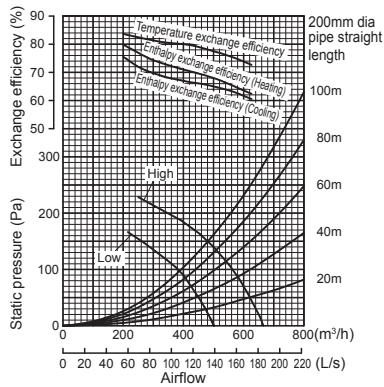

### Dimensions

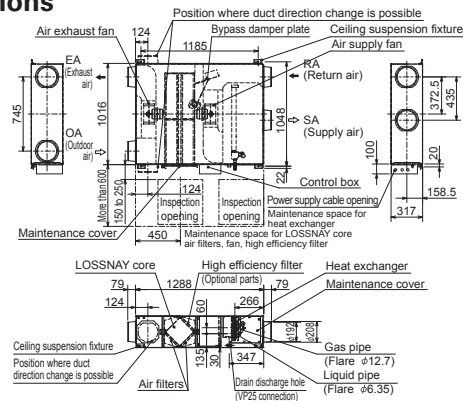

Unit: mm

### GUF-100RD4

Electrical power supply		220-240V/50Hz			
		Heat recovery mode		Bypass mode	
Ventilation mode					
Fan speed		High	Low	High	Low
Running current (A)		2.20	1.73	2.25	1.77
Input power (W)		480-505	370-395	490-515	385-410
Airflow	(m <sup>3</sup> /h)	1000	800	1000	800
	(L/s)	278	222	278	222
External static pressure (Pa)		140	90	140	90
Temperature exchange efficiency (%)		79.5	81.5	-	-
Enthalpy exchange efficiency (%)	Heating	71	74	-	-
	Cooling	69	71	-	-
Cooling capacity (kW)		11.44 (4.12)			
Heating capacity (kW)		12.56 (4.26)			
Capacity equivalent to the indoor unit		P63			
Humidifier	Humidifying	-			
	Humidifying capacity (kg/h)	-			
	Water supply pressure	-			
Noise (dB) (Measured at 1.5m under the center of the unit in an anechoic chamber)		38-39	34-35	38-39	35-36
Weight (kg)		82			

### Characteristic Curves

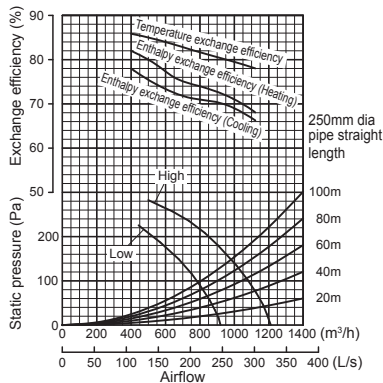

### Dimensions

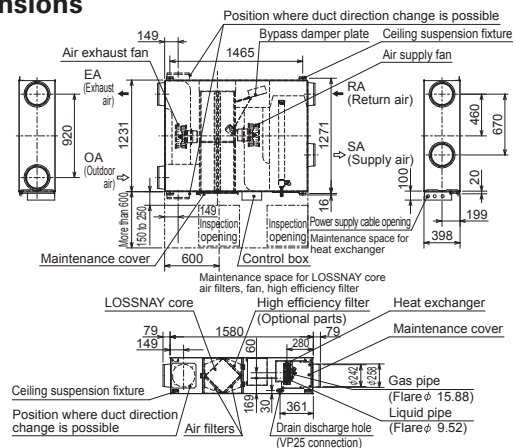

Unit: mm

■ For GUF series

\* Cooling/Heating capacity indicates the maximum value at operation under the following condition.

Cooling: Indoor: 27°C DB/19°C WB Outdoor: 35°C DB/24°C WB

Heating: Indoor: 20°C DB/13.8°C WB Outdoor: 7°C DB/6°C WB

\* The figures in ( ) indicates heat recovering capacity of heat exchange core.

\* Figures in the chart are measured according to Japan Industrial Standard (JIS B 8628). Characteristic Curves are measured by chamber method.

\* When the total capacity of indoor units connected to 1 outdoor units (PUHY or PURY) exceeds the capacity of the total unit, the total capacity of GUF needs to be 30% and less of the connected outdoor unit capacity.

\* Specifications may be subject to change without notice.



# CONTROL TECHNOLOGIES

PZ-62DR-EA/EB

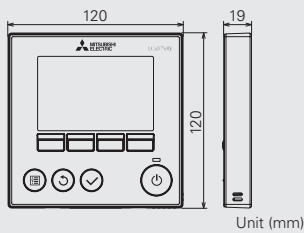

Unit (mm)

PZ-43SMF-E

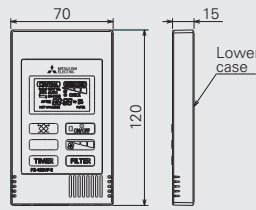

Unit (mm)

Language	-EA	-EB
English	●	●
German	●	●
Spanish	●	●
French	●	●
Italian		●
Russian	●	
Portuguese		●
Swedish		●
Dutch	●	
Turkish	●	
Polish	●	
Greek		●
Czech	●	
Hungarian	●	
Slovenian		●
Bulgarian	●	
Danish		●

## Compatibility Table

Remote Controller Compatibility Table			
Model name	PZ-62DR-EA/EB		PZ-43SMF-E
Compatible series	LGH-RVX3/RVS	LGH-RVXT	LGH-RVX3/RVXT/RVS
Fan speed selection	4 fan speeds and Auto (Auto is available when using a CO <sub>2</sub> sensor)	4 fan speeds	2 of 4 fan speeds
Control with a CO <sub>2</sub> sensor (Mitsubishi Electric)	Yes (Fan speed automatically changes from 25% to 100% depending on the CO <sub>2</sub> concentration*)	No	No
Control with a CO <sub>2</sub> sensor (field supply)	Yes (Fan speed automatically changes from 25% to 100% depending on the CO <sub>2</sub> concentration*)	Yes (Fan speed automatically changes between 4 levels depending on the CO <sub>2</sub> concentration)	No
Ventilation mode selection	Energy recovery/Bypass/Auto	Energy recovery/Bypass/Auto	Energy recovery/Bypass/Auto
Night purge	Yes	Yes	No
Function setting from remote controller	Yes	Yes	No
Bypass temp. free setting	Yes	Yes (Set in Function setting menu)	No
Flexible airflow setting	Yes (Both supply and exhaust fan speeds can be set separately from 25% to 100% in 5% pitches)	No	No
ON/OFF timer	Yes	Yes	Yes
Auto-off timer	Yes	Yes	No
Weekly timer	Yes	Yes	No
Fan speed timer	Yes	Yes	No
Operation restrictions (ON/OFF, ventilation mode, fan speed)	Yes	Yes	No
Operation restrictions (fan speed skip setting)	Yes	Yes	No
Screen contrast adjustment	Yes	Yes	No
Language selection	Yes (17 languages)	Yes (17 languages)	No (English only)
CO <sub>2</sub> concentration indication	Yes (available when using a Mitsubishi Electric CO <sub>2</sub> sensor)	No	No
Filter cleaning sign	Yes (Maintenance interval can be changed)	Yes	Yes
LOSSNAY core cleaning sign	Yes/No (RVS series)	Yes	No
Error indication	Yes (Displays model name, serial number, contact information)	Yes (Displays model name, serial number, contact information)	Yes
Error history	Yes	Yes	No
OA/RA/SA temp. display	Yes	Yes	No

\*When using a CO<sub>2</sub> sensor. Upper and lower limits may differ.



## CO<sub>2</sub> Sensors

A CO<sub>2</sub> Sensor connected directly to a LOSSNAY RVX3 and RVS unit optimizes the fan speed according to the detected CO<sub>2</sub> level.

Duct-mounted type

### PZ-70CSD-E

Equipped to the duct with all wiring hidden in the ceiling.

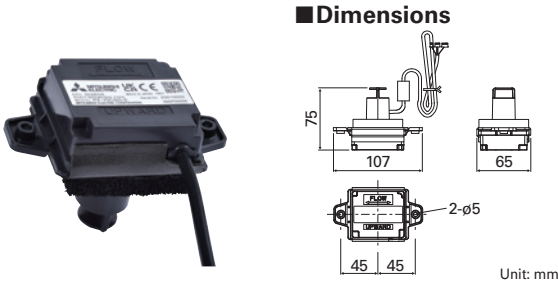

Wall-mounted type

### PZ-70CSW-E

Installed on the wall. CO<sub>2</sub> Level can be monitored in 3 levels.

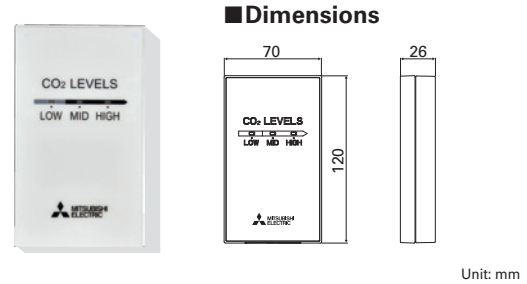

## Vertical Installation Plate

### PZ-1VS-E, PZ-2VS-E

Parts needed to install RVX3 vertically.

#### ■ Dimensions

	A	B	Weight (kg)	Applicable model
PZ-1VS-E	280	200	1.2	LGH15 to 50RVX3-E
PZ-2VS-E	380	300	1.6	LGH65 to 100RVX3-E

Unit: mm



EA side plate  
RA side plate

#### EA side plate

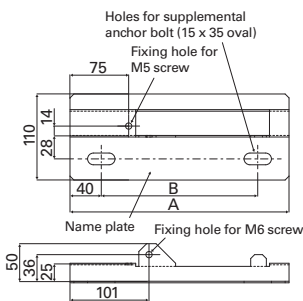

#### RA side plate

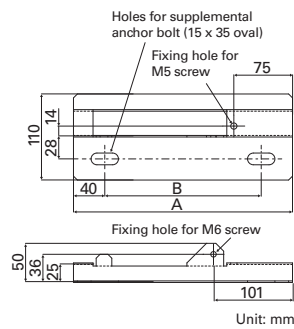

Unit: mm

## Signal Output Terminal

### PZ-4GS-E

PCB of RVX3 and RVS has only 1 output terminal. By using PZ-4GS-E, it allows to add 4 more output terminals can be added to RVX3 and RVS.

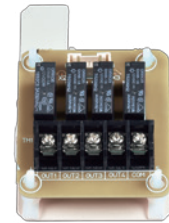

#### ■ Wiring diagram

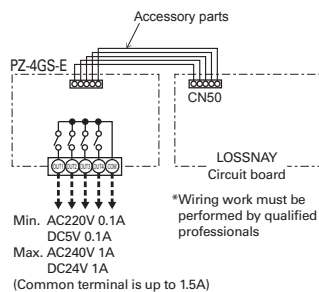

#### ■ Dimensions

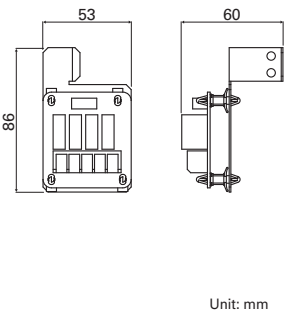

## Duct Silencer

The duct silencer connects to the LOSSNAY unit to reduce airflow noise.

Four sizes are available to cover a wide range of duct sizes.

#### ■ Dimensions

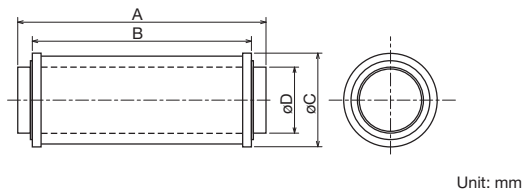

Model	A	B	C	D	Connecting duct	Weight (kg)
PZ-100SS-E	450	400	152	99	φ100	1.9
PZ-150SS-E	560	500	202	149	φ150	3.5
PZ-200SS-E	660	600	252	199	φ200	5.3
PZ-250SS-E	660	600	332	249	φ250	8.9





#### ■ Specifications

Model	Airflow [m <sup>3</sup> /h]	Attenuation of sound power level [dB] for center frequency (discharge)							
		62.5Hz	125Hz	250Hz	500Hz	1000Hz	2000Hz	4000Hz	8000Hz
PZ-100SS-E	50	0	3	5	7	6	6	6	8
	150	0	3	6	7	7	7	7	9
PZ-150SS-E	250	0	1	5	8	15	21	20	14
	350	0	1	4	8	14	21	21	16
PZ-200SS-E	500	0	1	4	7	13	18	16	9
	650	0	1	3	8	12	17	14	6
PZ-250SS-E	800	0	2	4	12	22	21	14	13
	1000	0	1	4	12	22	20	14	13

- Figures on the chart above are based on the comparison with a general steel duct of the same length.
- The silencer is placed on just before the outlet during the measurement.
- When the airflow rate differs, the insertion loss is also different from the chart above.
- Figures on the chart above are flat (No-weighted) values.



## Lineup and Classification

LOSSNAY			Filter				
Model	Filter		Name	Model	Material	Classification	
	Standard Setting	Optional Setting				ISO 16890: 2016	EN 779: 2012
	●		Replacement filter (Coarse 60% filter)	PZ-**RF3-E	Non-woven fabric	Coarse 60%	–
		●	Advanced high-efficiency filter (ePM1 75% filter)	PZ-**RFP3-E	Synthetic fiber	ePM1 75%, ePM2.5 80%, ePM10 95%	–
		●*1	High-efficiency filter (M6 filter)	PZ-**RFM3-E	Synthetic fiber	–	M6
		●*1	Advanced high-efficiency filter (F8 filter)	PZ-**RFH3-E	Synthetic fiber	–	F8
	●		Replacement filter (Coarse 50% filter)	PZ-**RTF-E	Non-woven fabric	Coarse 50%	G3
		●	Advanced high-efficiency filter (M6 filter)	PZ-M6RTFM-E	Non-woven fabric	ePM10 75%	M6
		●	Advanced high-efficiency filter (F8 filter)	PZ-F8RTFM-E	Non-woven fabric	ePM1 65%	F8
		●*1	Advanced high-efficiency filter (M6 filter)	PZ-M6TDF-E	Non-woven fabric	–	M6
		●*1	Advanced high-efficiency filter (F8 filter)	PZ-F8TDF-E	Non-woven fabric	–	F8
	●		Replacement filter (Coarse 50% filter)	PZ-S**RFE	Non-woven fabric	Coarse 50%	G3
		●	High-efficiency filter (ePM10 80% filter)	PZ-S**RFM-E	Synthetic fiber	ePM10 80%	M6
		●	Advanced high-efficiency filter (ePM1 65% filter)	PZ-S**RFH-E	Synthetic fiber	ePM1 65%, ePM2.5 75%, ePM10 90%	F8
	●		Replacement filter (Coarse 35% filter)	PZ-**RF8-E	Non-woven fabric	Coarse 35%	G3
		●	High-efficiency filter (ePM10 75%)	PZ-**RFM-E	Noncombustible fiber	ePM10 75%	–
		●	Advanced high-efficiency filter (ePM1 75%)	PZ-**RFP2-E	Synthetic fiber	ePM1 75%, ePM2.5 80%, ePM10 95%	–





\*1: Designed for Spanish market to apply RITE (Regulation of Thermal Installations of Buildings)

## For LGH-RVX3 Series

Image	Filter						Pieces in one package	Package number for replacement	Installation location			
	Model	Applicable model	Dimension (mm)			Numbers of filters			OA	RA	SA	
			L	W	H							
	PZ-15RF3-E	LGH-15RVX3-E	549	125	20	2	1	2	1	1	–	
	PZ-25RF3-E	LGH-25RVX3-E	654	151	15	2	1	2	1	1	–	
	PZ-35RF3-E	LGH-35RVX3-E	784	178	15	2	1	2	1	1	–	
	PZ-50RF3-E	LGH-50RVX3-E	926	178	15	2	1	2	1	1	–	
	PZ-65RF3-E	LGH-65RVX3-E	852	213	15	2	1	2	1	1	–	
	PZ-80RF3-E	LGH-80RVX3-E	890	238	15	2	1	2	1	1	–	
		LGH-160RVX3-E					2	4	2	2	–	
	PZ-100RF3-E	LGH-100RVX3-E	1117	238	15	2	1	2	1	1	–	
LGH-200RVX3-E		2					4	2	2	–		

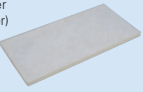
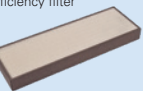

\*2: Designed for Spanish market to apply RITE (Regulation of Thermal Installations of Buildings)

## For LGH-RVXT Series

Image	Filter					Pieces in one package	Package number for replacement	Installation location			
	Model	Applicable model	Dimension (mm)					Numbers of filters			
			L	W	H			OA	RA	SA	
 Replacement filter (Coarse 50% filter)	PZ-150RTF-E	LGH-150RVXT-E	655	290	-	2	1	4	2	-	-
			655	250	-	2		4	-	2	-
	PZ-250RTF-E	LGH-200RVXT-E, LGH-250RVXT-E	985	290	-	2	1	4	2	-	-
			985	250	-	2		4	-	2	-
 Advanced high-efficiency filter (M6 filter)	PZ-M6RTFM-E	LGH-150RVXT-E, LGH-200RVXT-E, LGH-250RVXT-E	659	223	65	3	1	3	-	-	3
 Advanced high-efficiency filter (F8 filter)			PZ-F8RTFM-E	LGH-150RVXT-E, LGH-200RVXT-E, LGH-250RVXT-E	659	223		65	3	1	3
 Advanced high-efficiency filter*3 (M6 filter)	PZ-M6TDF-E	LGH-150RVXT-E, LGH-200RVXT-E, LGH-250RVXT-E			659	223	27	3	1		3
 Advanced high-efficiency filter*3 (F8 filter)			PZ-F8TDF-E	LGH-150RVXT-E, LGH-200RVXT-E, LGH-250RVXT-E	659	223	27	3		1	3

\*3: Designed for Spanish market to apply RITE (Regulation of Thermal Installations of Buildings)

## For LGH-RVS Series

Image	Filter					Pieces in one package	Package number for replacement	Installation location			
	Model	Applicable model	Dimension (mm)					Numbers of filters			
			L	W	H			OA	RA	SA	
 Replacement filter (Coarse 50% filter)	PZ-S50RF-E	LGH-50RVS-E	845	195	15	2	1	2	1	1	-
			PZ-S80RF-E	LGH-80RVS-E	885	195		15	2	2	1
	PZ-S100RF-E	LGH-100RVS-E	1112	195	15	2	1	2	1	1	-
			 High-efficiency filter (ePM10 80% filter)	PZ-S50RFM-E	LGH-50RVS-E	422		195	15	2	1
PZ-S80RFM-E	LGH-80RVS-E	442	195			15	2	1	2	2	
		PZ-S100RFM-E	LGH-100RVS-E	556	195	15	2		1	2	2
 Advanced high-efficiency filter (ePM1 65% filter)	PZ-S50RFH-E			LGH-50RVS-E	412	203	25	2		1	2
		PZ-S80RFH-E	LGH-80RVS-E		432	203	25	2	1		2
	PZ-S100RFH-E			LGH-100RVS-E	546	203	25	2		1	2

## For GUF Series

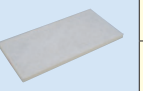
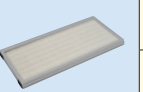
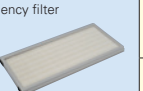
Image	Filter					Pieces in one package	Package number for replacement	Installation location			
	Model	Applicable model	Dimension (mm)					Numbers of filters			
			L	W	H			OA	RA	SA	
 Replacement filter (Coarse 35% filter)	PZ-50RF8-E	GUF-50RD4 GUF-50RDH4	470	183	15	4	1	4	2	2	-
			PZ-100RF8-E	GUF-100RD4 GUF-100RDH4	565	243		15	4	1	4
 High-efficiency filter (ePM10 75% filter)	PZ-50RFM-E	GUF-50RD4 GUF-50RDH4			464	175	25	2	1		2
			PZ-100RFM-E	GUF-100RD4 GUF-100RDH4	559	236	25	2		1	2
 Advanced high-efficiency filter (ePM1 75% filter)	PZ-50FRP2-E	GUF-50RD4 GUF-50RDH4			464	175	25	2	1		2
			PZ-100FRP2-E	GUF-100RD4 GUF-100RDH4	559	236	25	2		1	2

\*Specifications may be subject to change without notice.

# VL-CZPVU SERIES

Vertical-type centralized ventilation with sensible heat exchange for residential use.

VL-250CZPVU-R/L-E  
VL-350CZPVU-R/L-E  
VL-500CZPVU-R/L-E



## Key Features



### Quiet Operation

Noise is one of the most common concerns for residential ventilation. Ultra quiet operation is achieved with the sirocco fan designed by Mitsubishi Electric. The balance between airflow and static pressure is optimized and the fan rotation is minimized, leading to low noise levels.

### Air Purification

An optional filter removes NO<sub>x</sub> and PM2.5 and improves indoor air quality. They can be incorporated inside the unit without any filter box, which saves space.

\*NO<sub>x</sub>: Nitrogen oxide, which includes nitric oxide (NO) and nitrogen dioxide (NO<sub>2</sub>).  
\*PM2.5: Airborne particulates that are 2.5µm or smaller in size.

### Wi-Fi Control

MELCloud is a Cloud-based solution for controlling LOSSNAY units either locally or remotely by computer, tablet or smartphone via the Internet. It allows LOSSNAY operations to be checked and controlled via MELCloud from virtually anywhere and Internet connection is available. With MELCloud, the LOSSNAY system can be used much more easily and conveniently.

## Energy Efficiency

Under regulation (EU) No. 1254/2014, the VL-CZPVU series has the highest energy-saving performance in its class (ErP A<sup>+</sup>). It saves heating and cooling costs by minimizing the energy loss that occurs during ventilation.

ErP A<sup>+</sup>

A<sup>+</sup>

## Variable Airflow Control

The default fan speed value (Fan speed 1: 30%, Fan speed 2: 50%, Fan speed 3: 70%, and Fan speed 4: 100%) of both supply air and exhaust air can be adjusted flexibly. Within the range between 25% and 100%, airflow can be adjusted by 1% increments to satisfactorily meet the designed airflow rate.

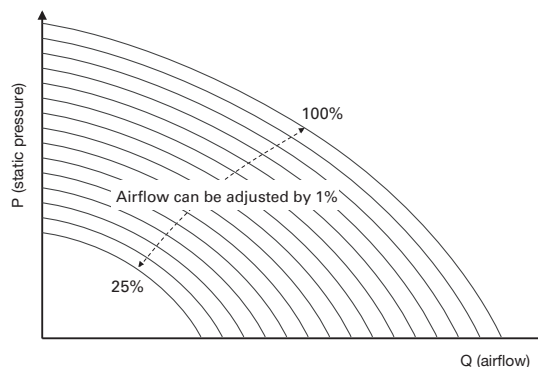

## External Airflow Control

The airflow from the LOSSNAY unit can be altered using 0-10V signals from the controllers, such as the humidity stat and CO<sub>2</sub> sensor (field supply). The LOSSNAY unit is also connected to the light switch which can boost operation mode (input 220-240V). These devices are connected directly to the LOSSNAY unit, allowing automatic fan speed control according to bathroom occupation, CO<sub>2</sub> level, and humidity level.

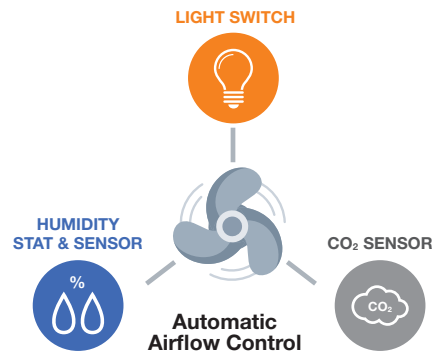

## Automatic Bypass Mode

It is possible to switch between "LOSSNAY ventilation (with heat exchange)" and "Bypass ventilation (without heat exchange)" either manually or automatically. When outside air is cooler than indoor air in summer, the unit directly draws in outside air, bypassing the heat exchanger.

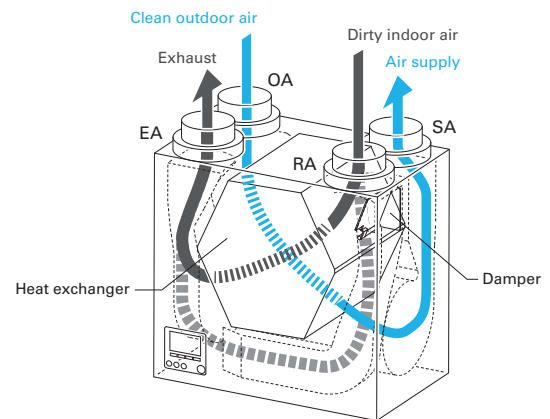

\* The figure shows VL-350CZPVU-L-E

## Wide Operating Temperature

The VL-CZPVU series can operate at temperatures down to  $-15^{\circ}\text{C}$ . With a pre-heater, it can operate at temperatures down to  $-25^{\circ}\text{C}$ .

\* In areas where outdoor air falls below  $-20^{\circ}\text{C}$ , an electric shutter (locally supplied) is required in the OA duct in addition to the pre-heater.

\* The OA temperature must be higher than  $-15^{\circ}\text{C}$  to use the pre-heater.

## MELCloud for LOSSNAY

MELCloud enables fast, easy remote control and monitoring of LOSSNAY units. Wireless computer connectivity and an Internet-connected mobile or fixed terminal are all that are needed. MELCloud can also be used to control room air conditioners and Ecodan heat pumps simultaneously.

### Key control and monitoring features

1. Turn system on/off
2. Switching airflow & operating mode (Heat recovery / Bypass)
3. Confirming the status of the filter/core (Maintenance notification)



# VL-CZPVU SERIES

## Specifications

### VL-250CZPVU-R/L-E

Electrical power supply	220-240V/50Hz, 220V/60Hz				
Ventilation mode	Heat recovery mode				
Fan speed	FS4 (100%)	FS3 (70%)	FS2 (50%)	FS1 (30%)	
Running current (A)	0.76	0.35	0.20	0.12	
Input power (W)	106	44	23	11	
Airflow	(m <sup>3</sup> /h)	250	175	125	75
	(L/s)	69	49	35	21
External static pressure (Pa)	150	74	38	14	
Temperature exchange efficiency (%)	85	87	88	90	
Noise level (dB)	31	22	16	15 >	
Energy efficiency class	A+				
Weight (kg)	26				
Dimensions (mm)	(H) 565 x (W) 595 x (D) 356				

#### Attention

- The above values are at factory default.
- The running current, the input power, the efficiency and the noise are based on the rating airflow, and 230V/50Hz.
- The sound pressure level at 3m is spherical.
- Temperature exchange efficiency (%) is based on winter condition.
- Mitsubishi Electric measures figures in the chart according to EN13141-7: 2010, and the characteristic curves are measured by chamber method.
- Specifications may be subject to change without notice.

### Characteristic Curves

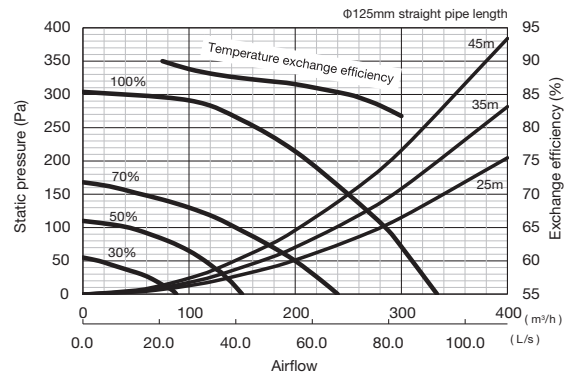

#### Attention

Mitsubishi Electric measures figures in the chart according to EN13141-7: 2010, and the characteristic curves are measured by chamber method.

## Dimensions

### VL-250CZPVU-R-E

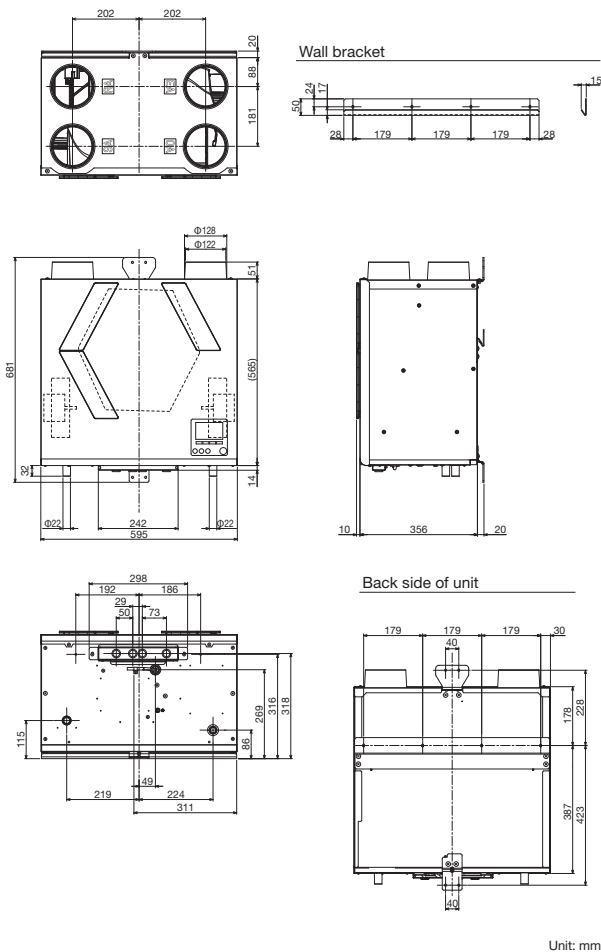

### VL-250CZPVU-L-E

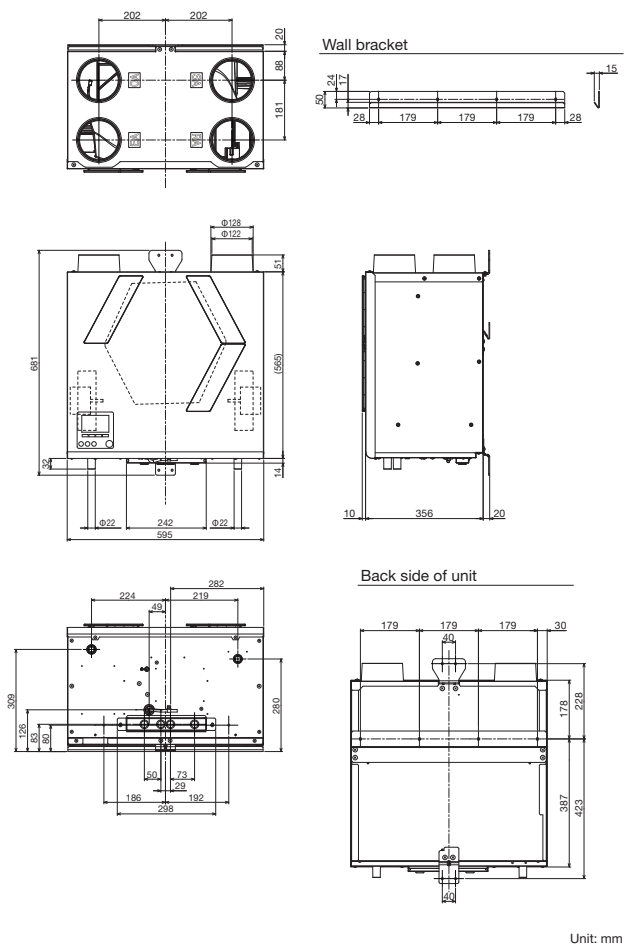

## VL-350CZPVU-R/L-E

Electrical power supply	220-240V/50Hz, 220V-/60Hz				
Ventilation mode	Heat recovery mode				
Fan speed	FS4 (100%)	FS3 (70%)	FS2 (50%)	FS1 (30%)	
Running current (A)	1.08	0.52	0.31	0.18	
Input power (W)	155	71	37	19	
Airflow	(m³/h)	320	224	160	96
	(L/s)	89	62	44	27
External static pressure (Pa)	150	74	38	14	
Temperature exchange efficiency (%)	85	87	88	90	
Noise level (dB)	35	26	19	15>	
Energy efficiency class	A+				
Weight (kg)	32				
Dimensions (mm)	(H) 623 x (W) 658 x (D) 432				

### Attention

- The above values are at factory default.
- The running current, the input power, the efficiency and the noise are based on the rating airflow, and 230V/50Hz.
- The sound pressure level at 3m is spherical.
- Temperature exchange efficiency (%) is based on winter condition.
- Mitsubishi Electric measures figures in the chart according to EN13141-7: 2010, and the characteristic curves are measured by chamber method.
- Specifications may be subject to change without notice.

## Characteristic Curves

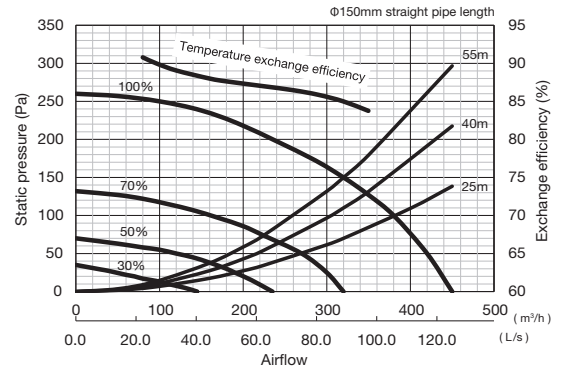

### Attention

Mitsubishi Electric measures figures in the chart according to EN13141-7: 2010, and the characteristic curves are measured by chamber method.

## Dimensions

### VL-350CZPVU-R-E

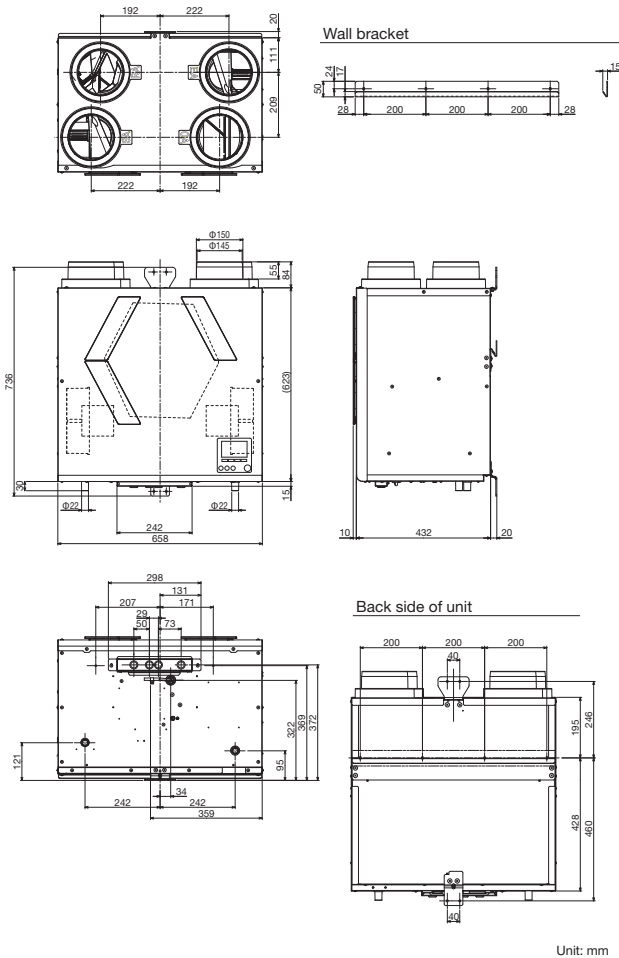

### VL-350CZPVU-L-E

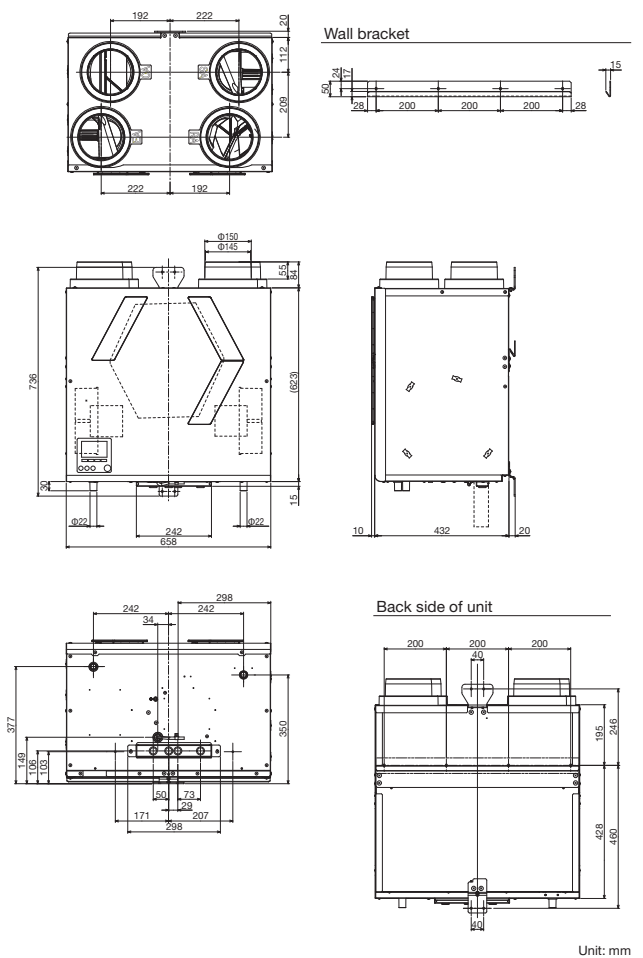

## VL-500CZPVU-R/L-E

Electrical power supply	220-240V/50Hz, 220V/60Hz				
Ventilation mode	Heat recovery mode				
Fan speed	FS4 (100%)	FS3 (70%)	FS2 (50%)	FS1 (30%)	
Running current (A)	1.73	0.77	0.40	0.19	
Input power (W)	275	104	49	21	
Airflow	(m <sup>3</sup> /h)	500	350	250	150
	(L/s)	139	97	69	42
External static pressure (Pa)	200	98	50	18	
Temperature exchange efficiency (%)	85	87	89	92	
Noise level (dB)	37	29	22	15>	
Energy efficiency class	A+				
Weight (kg)	39				
Dimensions (mm)	(H) 632 x (W) 725 x (D) 556				

### Attention

- The above values are at factory default.
- The running current, the input power, the efficiency and the noise are based on the rating airflow, and 230V/50Hz.
- The sound pressure level at 3m is spherical.
- Temperature exchange efficiency (%) is based on winter condition.
- Mitsubishi Electric measures figures in the chart according to EN13141-7: 2010, and the characteristic curves are measured by chamber method.
- Specifications may be subject to change without notice.

## Characteristic Curves

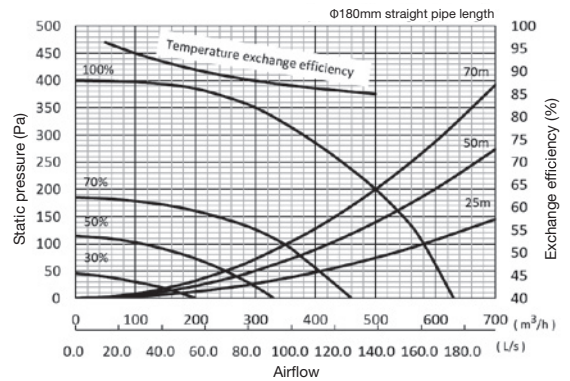

### Attention

Mitsubishi Electric measures figures in the chart according to EN13141-7: 2010, and the characteristic curves are measured by chamber method.

## Dimensions

### VL-500CZPVU-R-E

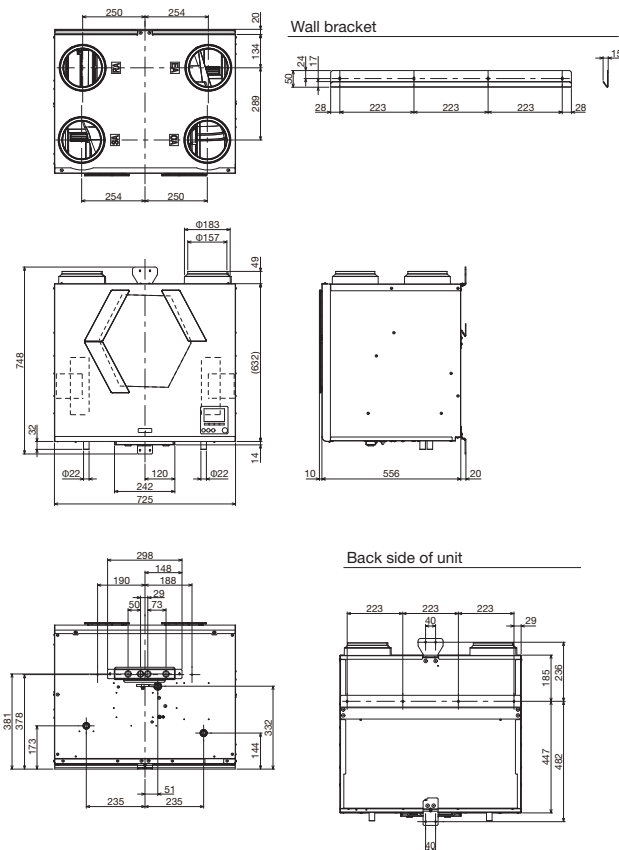

Unit: mm



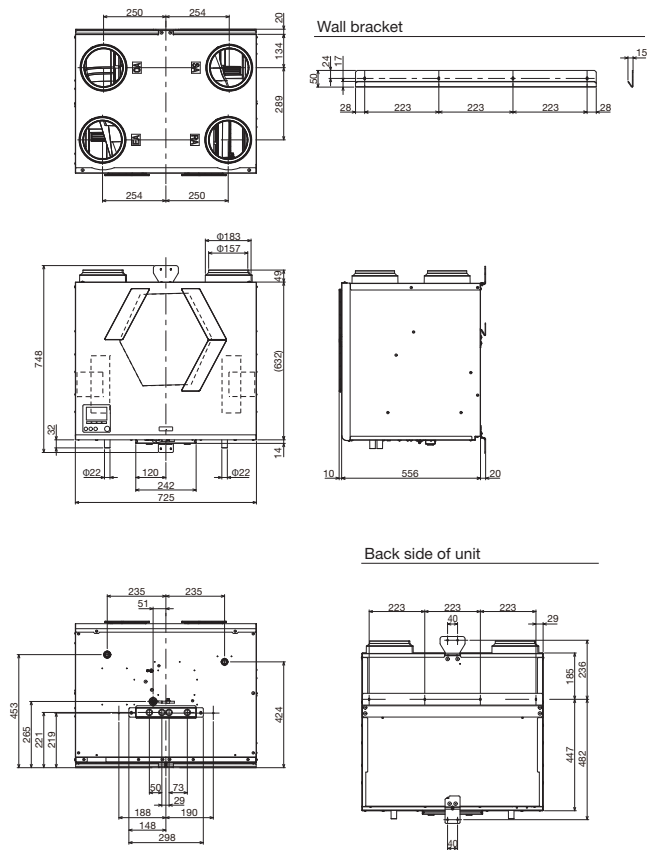

### VL-500CZPVU-L-E



Unit: mm

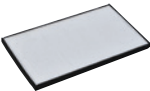

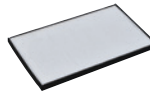
## Filters

Type	Replacement filter	Standard filter	Medium efficiency filter	Advanced efficiency filter	Advanced high efficiency filter	NOx Filter	
							
Model	P-250F-E P-350F-E P-500F-E	P-250SF-E P-350SF-E P-500SF-E	P-250MF-E P-350MF-E P-500MF-E	P-250PF-E P-350PF-E P-500PF-E	P-250PFH-E P-350PFH-E P-500PFH-E	P-250NF-E P-350NF-E P-500NF-E	
Classification	EN779 (2012)	G3	G4	M6	M6	ePM <sub>1</sub> 55%	NO <sub>2</sub> 90%
	ISO 16890 (2016)	Coarse 55%	Coarse 90%	ePM <sub>10</sub> 80%	ePM <sub>2.5</sub> 50%		

## Pressure loss characteristics

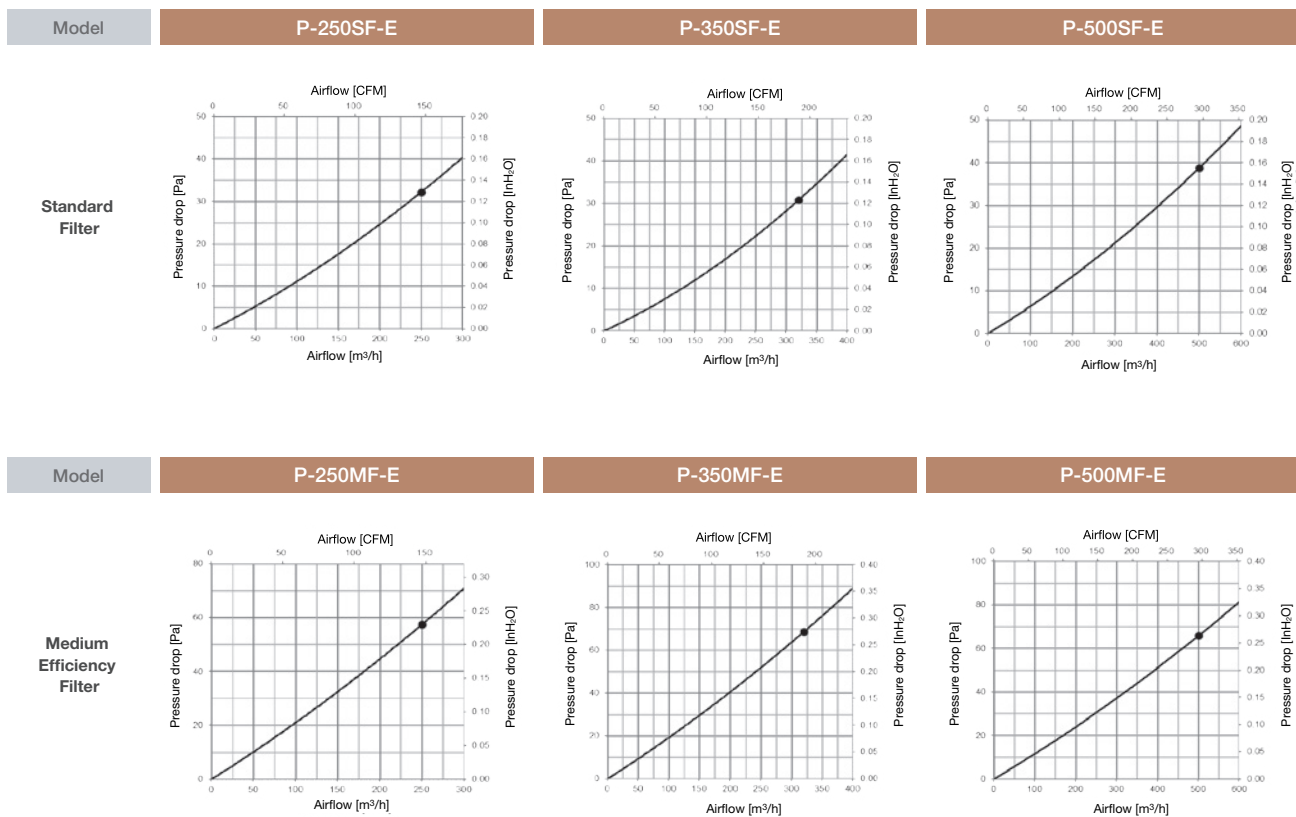

## Pressure loss characteristics

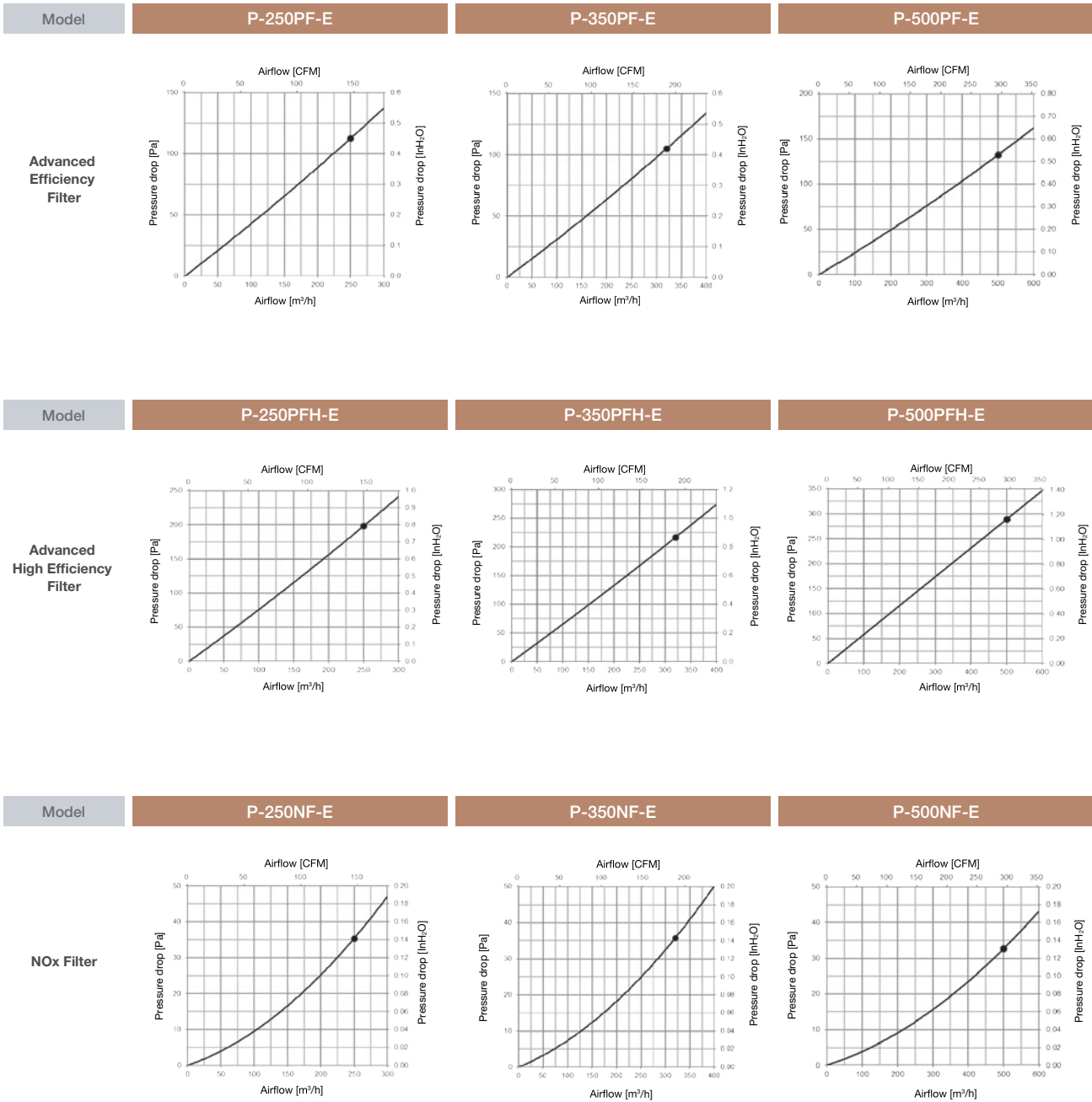

# Silencer Box

P-250/350/500SB-E

Noise level can be further decreased by using a silencer box.



Installation Image

## Model P-250SB-E

### Attenuation of sound power level for center frequency

Airflow (m <sup>3</sup> /h)	Static pressure (Pa)	Point	Attenuation of sound power level for center frequency Hz (dB)							
			63	125	250	500	1000	2000	4000	8000
175	74	Outlet (SA/EA)	9	7	11	19	29	28	21	13

- Figures in the chart above are measured by Mitsubishi Electric.
- The silencer box is placed just after the outlet of the LOSSNAY unit as specified in the Installation Manual.
- When airflow differs, attenuation may also differ from the chart above.

### Pressure loss curve

The curve on the right shows the total pressure drop of the OA and SA or RA and EA ducts in the silencer box.

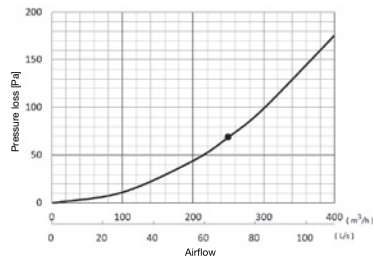

### Dimensions

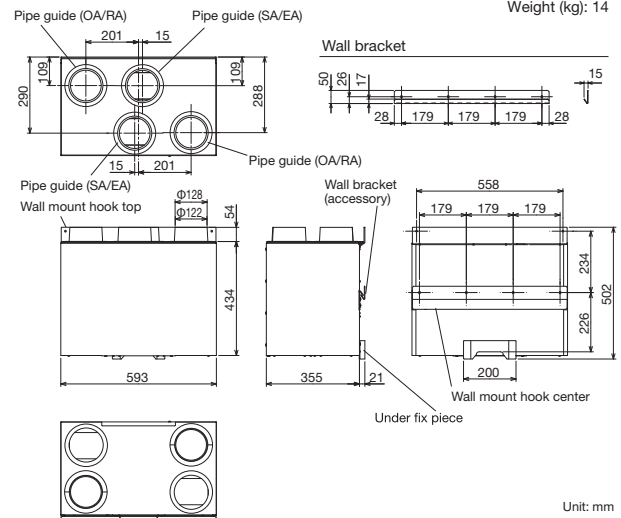

## Model P-350SB-E

### Attenuation of sound power level for center frequency

Airflow (m <sup>3</sup> /h)	Static pressure (Pa)	Point	Attenuation of sound power level for center frequency Hz (dB)							
			63	125	250	500	1000	2000	4000	8000
224	74	Outlet (SA/EA)	12	8	11	21	32	29	19	12

- Figures in the chart above are measured by Mitsubishi Electric.
- The silencer box is placed just after the outlet of the LOSSNAY unit as specified in the Installation Manual.
- When airflow differs, attenuation may also differ from the chart above.

### Pressure loss curve

The curve on the right shows the total pressure drop of the OA and SA or RA and EA ducts in the silencer box.

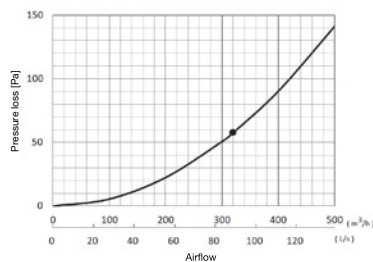

### Dimensions

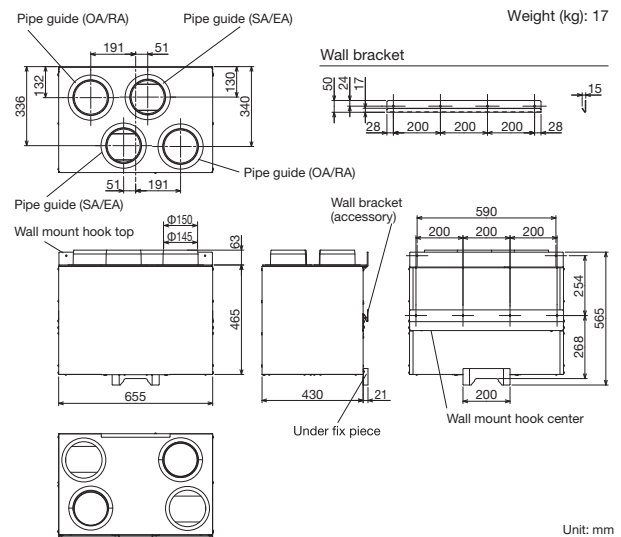

## Model

## P-500SB-E

### ■ Attenuation of sound power level for center frequency

Airflow (m <sup>3</sup> /h)	Static pressure (Pa)	Point	Attenuation of sound power level for center frequency Hz (dB)							
			63	125	250	500	1000	2000	4000	8000
350	98	Outlet (SA/EA)	10.5	9.5	13.0	21.0	27.0	29.0	26.0	14.0

- Figures on the chart above are measured by Mitsubishi Electric.
- The silencer box is placed on the just after the outlet of the LOSSNAY unit as specified in the Installation Manual.
- When the airflow differs, the attenuation may be also different from the chart above.

### ■ Pressure loss curve

The curve on the right shows the total pressure drop of the OA and SA or RA and EA ducts in the silencer box.

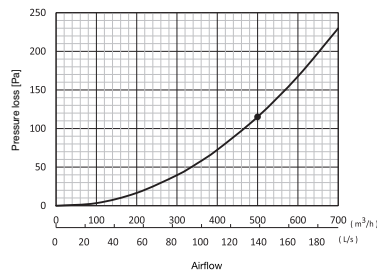

### ■ Dimensions

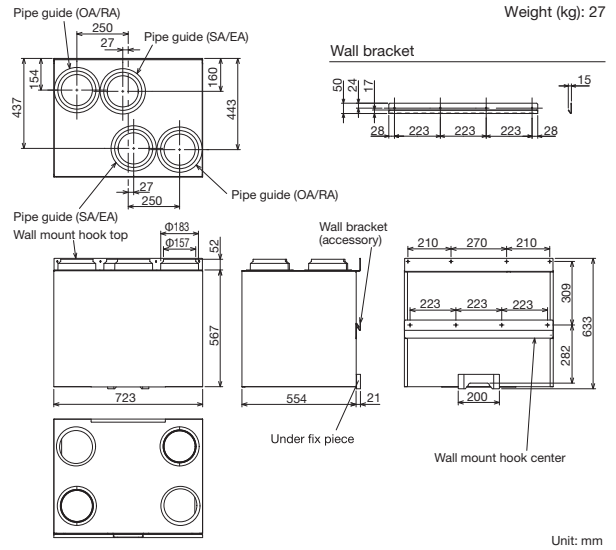

Unit: mm

## Remote Controller Cover

## P-RCC-E

By attaching a Remote Controller Cover, the remote controller can be installed at a distance from the unit.

### ■ Dimensions

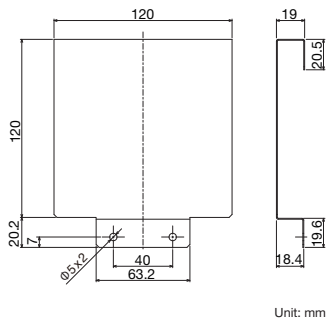

Unit: mm

### ■ Configuration

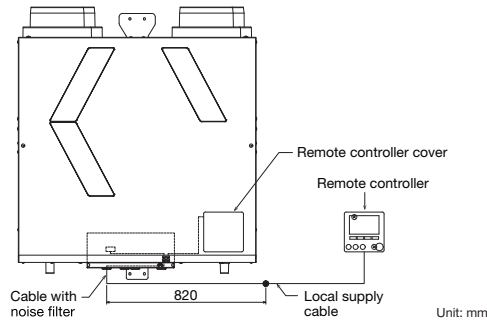

Unit: mm



Remote controller cover



Cable with noise filter  
(Cable length outside the product: Approximately 820 mm)

# VL-50(E)S<sub>2</sub>-E, VL-50SR<sub>2</sub>-E VL-100(E)U<sub>5</sub>-E

Wall-mounted models particularly suited for houses and small offices.



VL-50(E)S<sub>2</sub>-E  
VL-50SR<sub>2</sub>-E



VL-100(E)U<sub>5</sub>-E

## Decentralized Ventilation: VL-50(E)S<sub>2</sub>-E, VL-50SR<sub>2</sub>-E and VL-100(E)U<sub>5</sub>-E

### Product advantages

#### Air is supplied and exhausted simultaneously

Air is supplied and exhausted simultaneously while transferring the heat.

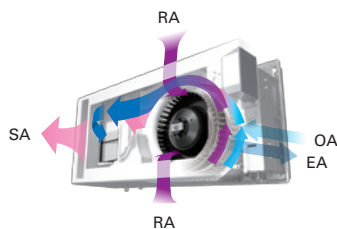

#### Energy efficient

- Total heat exchange minimizes heat loss.
- Achieve over 80%\* temperature efficiency.

\*VL-100(E)U<sub>5</sub>-E at low fan speed at 230V 50Hz

\*VL-50(E)S<sub>2</sub>-E at low fan speed at 230V 50Hz

Low noise levels are ideal for bedrooms and children's rooms.

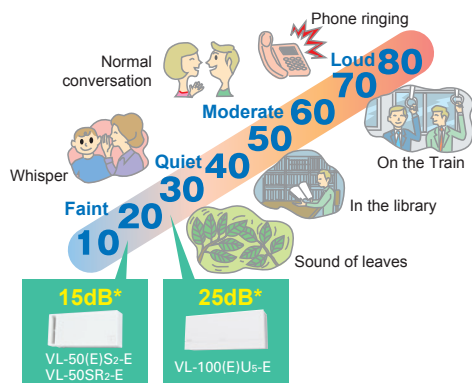

\*Condition: 50Hz, 230V, low fan speed

#### Sound insulation

A sound insulation effect reduces the level of noise generated outside.

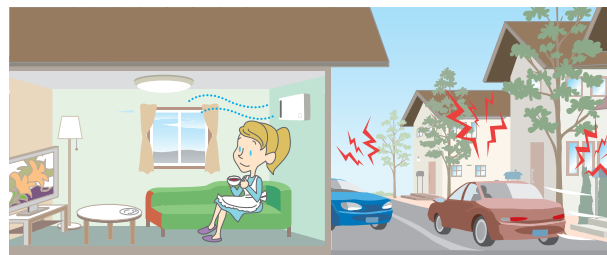

Sound insulation effect	Sound Source Side Average sound pressure dB	Sound Receiving Side Average sound pressure dB	Difference
	103.4	63.2	40.2

\*Tested using VL-08S<sub>2</sub>-AE

\*Measured by average sound pressure level of more than 30dB in 500Hz according to JIS A1416.

VL-08S<sub>2</sub>-AE is a Japanese dedicated model equivalent to VL-50(E)S<sub>2</sub>-E

### Easy maintenance

The only maintenance required is cleaning the outside air filter and exhaust air. Filters are easily accessible, making quick and thorough cleaning possible.

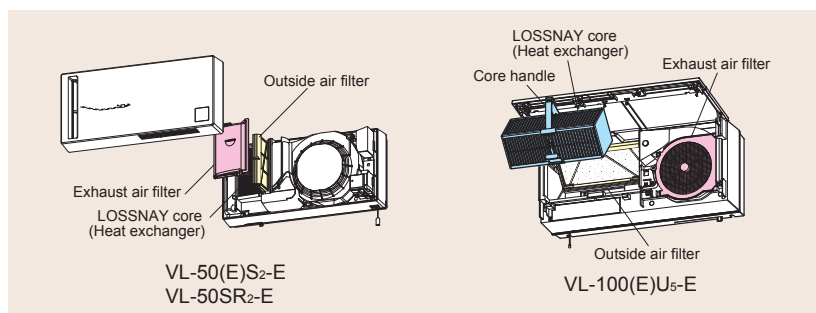

### Flexible installation for Only VL-50(E)S<sub>2</sub>-E and VL-50SR<sub>2</sub>-E

VL-50(E)S<sub>2</sub>-E and VL-50SR<sub>2</sub>-E may be installed either horizontally or vertically to fit in various types of rooms.

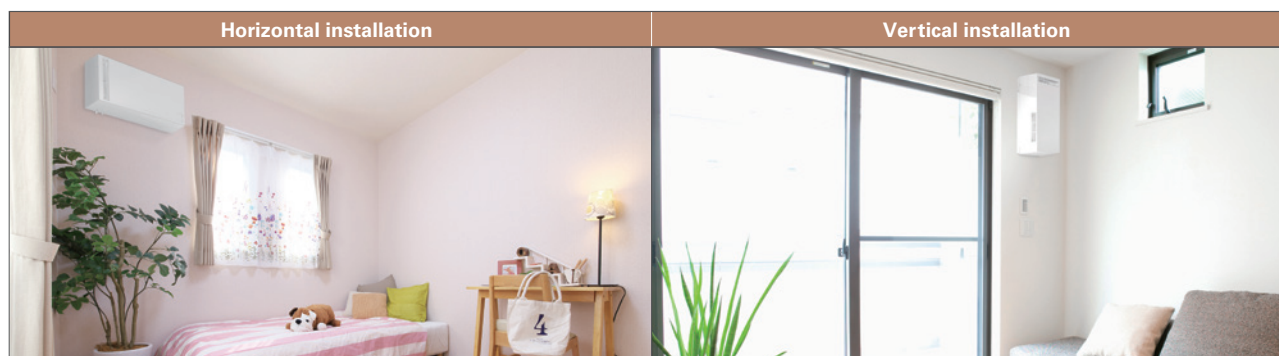



**Model: VL-100U5-E (Pull-Switch Model) and VL-100EU5-E (Wall-Switch Model)**

Model	VL-100(E)U5-E							
	220V/50Hz		230V/50Hz		240V/50Hz		220V/60Hz	
Electrical power supply	220V/50Hz		230V/50Hz		240V/50Hz		220V/60Hz	
Fan speed	High	Low	High	Low	High	Low	High	Low
Airflow (m <sup>3</sup> /h)	100	55	105	60	106	61	103	57
Power consumption (W)	30	13	31	15	34	17	34	17
Temperature exchange efficiency (%)	73	80	73	80	72	79	73	80
Noise level (dB)	36.5	24	37	25	38	27	38	25
Weight (kg)	7.5							
Specific energy consumption class	B							

\*Figures in the chart were measured according to Japan Industrial Standard (JIS B 8628) with the shutter knob in open position.

\*Specifications may be subject to change without notice.

**Dimensions**

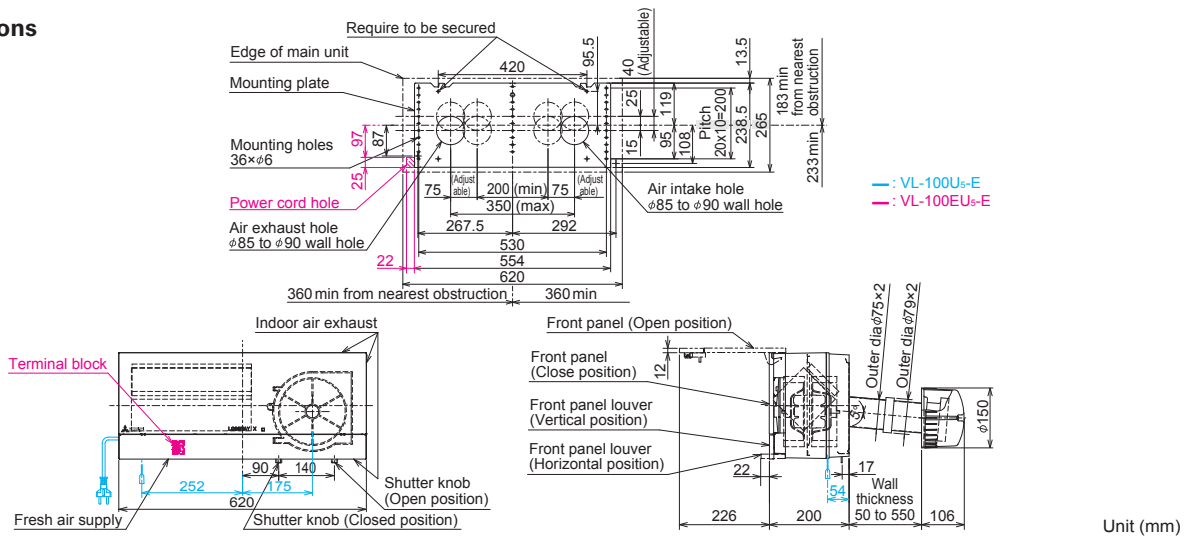

**Optional Parts**

**Optional Parts for VL-50(E)S2-E and VL-50SR2-E**

Filter, Extension Pipe and Stainless Hood

Type	Replacement Filter	High Efficiency Filter	Extension Pipe	Joint	Stainless Hood
Design					
Model	P-50F2-E	P-50HF2-E	P-50P-E	P-50PJ-E	P-50VSQ5-E
Feature	-	-	Total length when connected to the joint is 350mm.	Joint for extension pipe	Stylish stainless hood
Classification (EN779:2012)	G3	-	-	-	-
Classification (ISO16890)	Coarse 35%	ePM10 75%	-	-	-

**Optional Parts for VL-100(E)U5-E**

Filter and Extension Pipe

Type	Replacement Filter	High Efficiency Filter	Extension Pipe	Joint
Design				
Model	P-100F5-E	P-100HF5-E	P-100P-E	P-100PJ-E
Feature	-	-	Total length when connected to the joint is 300mm.	• Joint for extension pipe • Screw-in method
Classification (EN779:2012)	G3	M6	-	-
Classification (ISO16890)	Coarse 35%	ePM10 70%	-	-

# PLASMA QUAD PROTECT

JC-4K-EU, JC-23KR-EU

## Core Technology

The JC series is equipped with a Plasma Quad electronic device. It is also equipped with a blower fan, so air control is performed while creating a circulating airflow. As a result, indoor air quality is improved. Two models are available to suit various spaces.

### Suppresses viruses



Test result of operating the unit with an air volume of 230m<sup>3</sup>/h in a 25m<sup>3</sup> closed space:  
99% suppression in 25 minutes  
This result does not represent the product's performance in a practical operating environment.

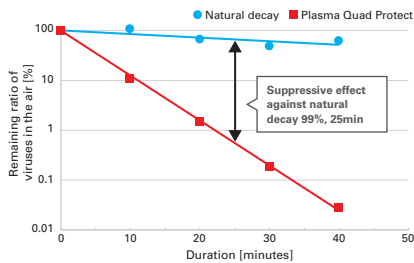

[Testing laboratory] Kitasato Research Center for Environmental Science  
[Testing method] Spraying virus in 25m<sup>3</sup> of closed space, collecting the air in the space after a certain period of time, and measuring the amount of virus in the air.  
[Condition] Operating JC-23KR-EU with an air volume of 230m<sup>3</sup>/h, 1 type of virus  
[Result] 99% suppression after 25min.  
Test Report No.2022\_0421

### Suppresses bacteria



Test result of operating the unit with an air volume of 230m<sup>3</sup>/h in a 25m<sup>3</sup> closed space:  
99% suppression in 28 minutes  
This result does not represent the product's performance in a practical operating environment.

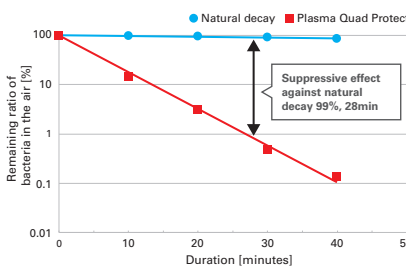

[Testing laboratory] Kitasato Research Center for Environmental Science  
[Testing method] Spraying bacteria in 25m<sup>3</sup> of closed space, collecting the air in the space after a certain period of time, and measuring the amount of bacteria in the air.  
[Condition] Operating JC-23KR-EU with an air volume of 230m<sup>3</sup>/h, 1 type of bacteria  
[Result] 99% suppression after 28min.  
Test Report No.2022\_0420

### Removes 99% PM2.5



Test result of operating the unit with an air volume of 230m<sup>3</sup>/h in a 27.5m<sup>3</sup> closed space: 99% suppression in 31 minutes  
PM2.5 is a general term for fine particulate matter of 2.5µm or less

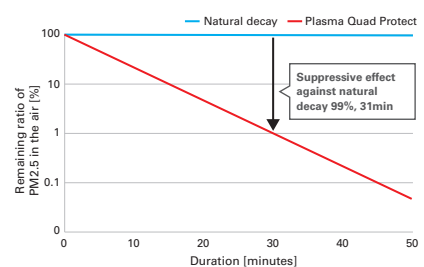

[Testing method] According to JEM1467.  
Operating JC-23KR-EU (230m<sup>3</sup>/h, 31min.) in a closed space of 27.5m<sup>3</sup>. Additional particle from outside is not considered. This result does not represent the product's performance in an actual operating environment.

## Air Purifier Type

## Features and Concept

### Flat and Stylish Design

JC-23KR-EU is a large air volume type. It is an air purifier equipped with a HEPA\*1 filter with a CADR\*2 rating. The stylish wall-mounted design matches almost any space.



\*1: HEPA filter rated as an EN1822 H13 grade.

\*2: CADR (Clean Air Delivery Rate) value of 254m<sup>3</sup>/h (pollen), 222m<sup>3</sup>/h (dust) and 228m<sup>3</sup>/h (smoke).



## Circulation throughout the Room

JC-23KR-EU creates circulation flow throughout the room. It sucks air into the product and first passes it through a dust filter. The air is then delivered to the HEPA filter and Plasma Quad device. The purified air is transported from the product to the entire room.

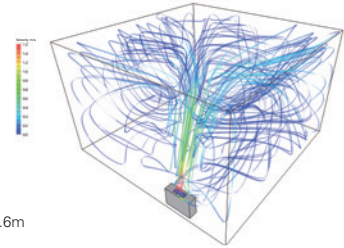

[Conditions for airflow simulation]  
Air volume: 230m<sup>3</sup>/h (powerful mode)  
Room dimensions: width 4.3m, depth 4.3m, height 2.6m  
No wind, air current or ventilation in the room.

## Visualization of Air Quality

JC-23KR-EU can be connected to MELCloud in the same way as air conditioners and LOSSNAY. By connecting to MELCloud, it is possible to check IAQ information and control air quality via the MELCloud app.



## Specifications and Dimensions

This product has two manual operation modes: Powerful and Silent. It also has an Auto mode. When in Auto mode, the sensor detects the level of dirt in the room and operates with an appropriate air volume.

### JC-23KR-EU



#### Specifications

Voltage	Fan speed	Power consumption [W]	Air volume [m <sup>3</sup> /h]	Noise level [dB]	Weight [kg]
220V	Silent	8	20	34	8.5
	Powerful	63.5	230	72	
230V	Silent	8	20	34	
	Powerful	63.5	230	72	
240V	Silent	8	20	34	
	Powerful	63.5	230	72	

#### Dimensions

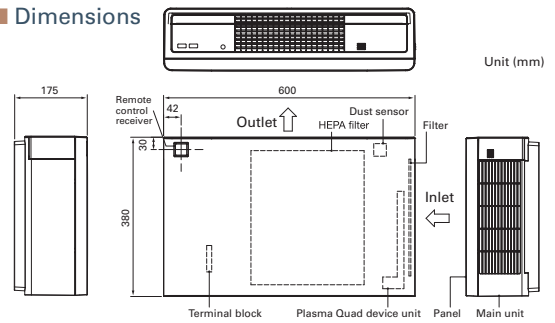

#### P-23KHF-E

#### Replacement Filter

When the HEPA filter needs to be replaced, please order the optional parts P-23KHF-E.



## Air Circulator Fan Type

JC-4K-EU is a small air volume type product. It is installed on the ceiling or the wall. Dust filters and the Plasma Quad device will clean the air in the room. Use "High" fan speed to quickly improve indoor air quality, air "Low" fan speed for quiet operation.



### JC-4K-EU

#### Dimensions

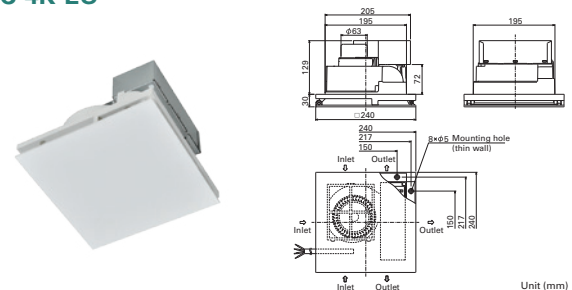

#### Specifications

Voltage	Fan speed	Power consumption [W]	Air volume [m <sup>3</sup> /h]	Noise level [dB]	Weight [kg]
220V	High	11.5	38	35	2.4
	Low	7.5	19	20	
230V	High	12.5	40	36.5	
	Low	8	20	21	
240V	High	13.5	42	38.5	
	Low	8.5	21	22	

\*Specifications may be subject to change without notice.

Optional parts		Model	LGH-15RVX3-E	LGH-25RVX3-E	LGH-35RVX3-E	LGH-50RVX3-E	LGH-65RVX3-E	LGH-80RVX3-E	LGH-100RVX3-E	LGH-160RVX3-E	LGH-200RVX3-E	LGH-150RVXT-E	LGH-200RVXT-E	LGH-250RVXT-E	LGH-50RVS-E	LGH-80RVS-E	LGH-100RVS-E	GUF-50RD4	GUF-50RDH4	GUF-100RD4	GUF-100RDH4				
LOSSNAY remote controller		PZ-62DR-EA/EB	●	●	●	●	●	●	●	●	●	●	●	●	●	●	●								
		PZ-43SMF-E	●	●	●	●	●	●	●	●	●	●	●	●	●	●	●								
Filter	Replacement filter	PZ-**RF3-E (Coarse 60% filter)	PZ-15RF3-E	●																					
			PZ-25RF3-E		●																				
			PZ-35RF3-E			●																			
			PZ-50RF3-E				●																		
			PZ-65RF3-E					●																	
			PZ-80RF3-E						●																
		PZ-100RF3-E							●																
		PZ-**RTF-E (Coarse 50% filter)	PZ-150RTF-E											●											
			PZ-250RTF-E												●	●									
			PZ-S50RF-E																●						
			PZ-S80RF-E																	●					
			PZ-S100RF-E																		●				
	PZ-50RF8-E																			●	●				
	PZ-100RF8-E	PZ-100RF8-E																			●	●			
		PZ-**RFM3-E*1 (M6 filter)	PZ-15RFM3-E	●																					
			PZ-25RFM3-E		●																				
			PZ-35RFM3-E			●																			
			PZ-50RFM3-E				●																		
			PZ-65RFM3-E					●																	
	PZ-80RFM3-E							●																	
	PZ-100RFM3-E	PZ-100RFM3-E							●			●													
		PZ-S**RFM-E (ePM10 80% filter)	PZ-S50RFM-E															●							
			PZ-S80RFM-E																●						
			PZ-S100RFM-E																	●					
		PZ-**RFM-E (ePM10 75% filter)	PZ-50RFM-E																	●	●				
			PZ-100RFM-E																		●	●			
	PZ-100RFM-E																				●	●			
	Advanced high-efficiency filter	PZ-**RFP3-E (ePM1 75% filter)	PZ-15RFP3-E	●																					
			PZ-25RFP3-E		●																				
			PZ-35RFP3-E			●																			
			PZ-50RFP3-E				●																		
			PZ-65RFP3-E					●																	
			PZ-80RFP3-E						●																
		PZ-100RFP3-E	PZ-100RFP3-E							●			●												
			PZ-**RFH3-E*1 (F8 filter)	PZ-15RFH3-E	●																				
				PZ-25RFH3-E		●																			
				PZ-35RFH3-E			●																		
				PZ-50RFH3-E				●																	
				PZ-65RFH3-E					●																
		PZ-80RFH3-E						●																	
		PZ-100RFH3-E	PZ-100RFH3-E							●			●												
			PZ-**RTFM-E	PZ-M6RTFM-E (M6 Filter)										●	●	●									
PZ-F8RTFM-E (F8 Filter)														●	●	●									
PZ-F8TDF-E (F8 Filter)													●	●	●										
PZ-S**RFH-E (ePM1 65% filter)		PZ-S50RFH-E															●								
		PZ-S80RFH-E																●							
		PZ-S100RFH-E																	●						
PZ-**RFP2-E (ePM1 75% filter)		PZ-50RFP2-E																	●	●					
		PZ-100RFP2-E																		●	●				
CO2 sensor		PZ-70CSD-E	●	●	●	●	●	●	●	●	●					●	●	●							
		PZ-70CSW-E	●	●	●	●	●	●	●	●	●					●	●	●							
Vertical installation plates		PZ-1VS-E	●	●	●	●																			
		PZ-2VS-E					●	●	●																
Signal output terminal		PZ-4GS-E	●	●	●	●	●	●	●	●	●					●	●	●							
Duct silencer		PZ-**SS-E	PZ-100SS-E	●																					
			PZ-150SS-E		●	●																			
			PZ-200SS-E				●	●										●			●	●			
			PZ-250SS-E						●	●	●	●	●						●	●		●	●		

\*1: Designed for Spanish market to apply RITE (Regulation of Thermal Installations of Buildings)

Note: Please refer to each product page for required number of pieces/sets.

## Optional parts for VL-CZPVU Series

Residential

Optional parts		Model	VL-250CZPVU-R/L-E	VL-350CZPVU-R/L-E	VL-500CZPVU-R/L-E
Filter	Replacement filter (Coarse 55% filter)	P-250F-E	●		
		P-350F-E		●	
		P-500F-E			●
	Standard filter (Coarse 90% filter)	P-250SF-E	●		
		P-350SF-E		●	
		P-500SF-E			●
	Medium-efficiency filter (ePM10 80% filter)	P-250MF-E	●		
		P-350MF-E		●	
		P-500MF-E			●
	PM2.5 filter (ePM2.5 50% filter)	P-250PF-E	●		
		P-350PF-E		●	
		P-500PF-E			●
	PM1 filter (ePM1 55% filter)	P-250PFH-E	●		
		P-350PFH-E		●	
		P-500PFH-E			●
	NOx filter	P-250NF-E	●		
		P-350NF-E		●	
		P-500NF-E			●
Silencer box	P-250SB-E	●			
	P-350SB-E		●		
	P-500SB-E			●	
RC cover (remote controller cover)		P-RCC-E	●	●	●

## Optional parts for VL-50/100 Series

Residential

Optional parts		Model	VL-50S <sub>2</sub> -E	VL-50ES <sub>2</sub> -E	VL-50RS <sub>2</sub> -E	VL-100U <sub>5</sub> -E	VL-100EU <sub>5</sub> -E
Filter	Replacement filter	P-50F2-E	●	●	●		
		P-100F5-E				●	●
	High-efficiency filter	P-50HF2-E	●	●	●		
		P-100HF5-E				●	●
Extension pipe	P-50P-E	●	●	●			
	P-100P-E				●	●	
Pipe extension joint	P-50PJ-E	●	●	●			
	P-100PJ-E				●	●	
Stainless hood		P-50VSQ5-E	●	●	●		

 **NOTICE**

Our air-conditioning equipments and heat pumps contain a fluorinated greenhouse gas, R410A (GWP: 2088) or R32 (GWP: 675). \*These GWP values are based on Regulation (EU) No.517/2014 from IPCC 4th edition. In case of Regulation (EU) No.626/2011 from IPCC 3rd edition, these are as follows. R410A (GWP: 1975), R32 (GWP: 550)

 **CAUTION**

Do not install indoor units in areas (e.g. mobile phone base stations) where the emission of VOCs such as phthalate compounds and formaldehyde is known to be high as this may result in a chemical reaction.

 **WARNING**

When installing or relocating or servicing our air-conditioning equipment, use only the specified refrigerant (R410A or R32) to charge the refrigerant lines.

Do not mix it with any other refrigerant and do not allow air to remain in the lines.

If air is mixed with the refrigerant, then it can be the cause of abnormal high pressure in the refrigerant lines, and may result in an explosion and other hazards.

The use of any refrigerant other than that specified for the system will cause mechanical failure, system malfunction or unit breakdown. In the worst case, this could lead to a serious impediment to securing product safety.

## MITSUBISHI ELECTRIC CORPORATION

HEAD OFFICE: TOKYO BUILDING, 2-7-3 MARUNOUCHI, CHIYODA-KU, TOKYO 100-8310, JAPAN  
<https://www.mitsubishielectric.com/>

Full Product Line Catalogue  
E-2405224 (18692)



E-2405224



Revised publication effective Jan. 2024.  
Superseding publication of S-179-2-CA762-B Apr. 2023.  
Specifications are subject to change without notice.